

CRL SOLSTICE SLIDING DOOR ON FRAMED WALL

DOOR SYSTEM LIMITATIONS
 MAXIMUM GLASS PANEL WEIGHT: 550 lbs. (249.5 kg)
 MAXIMUM TRACK LENGTH: 16 ft. (305mm)
 FOR 1/2" (12.7mm) TO 3/4" (19mm) TEMPERED GLASS

- * TESTED TO 1,000,000 CYCLES
- * ADJUSTABLE DOOR STOPS
- * ADJUSTABLE TRACK HEIGHTS
- * 1/4" (6.3mm) BI-DIRECTIONAL TRACK LEVELING
- * ANTI-LIFT SAFETY MECHANISM
- * BLACK STAINLESS AND BRUSHED STAINLESS FINISHES

Revisions By:

C.R. LAURENCE CO. ARCHITECTURAL PRODUCTS
 2503 E. Vernon Avenue, Los Angeles, CA 90058-1897
 PH (800)-421-6144 FX: 800-587-7501 www.crlaurence.com

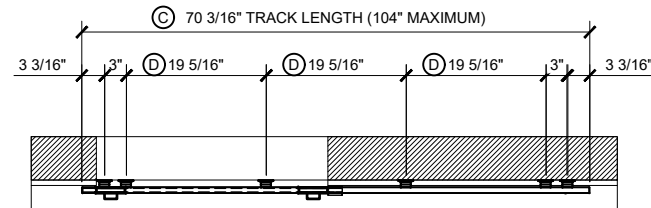

1A PLAN

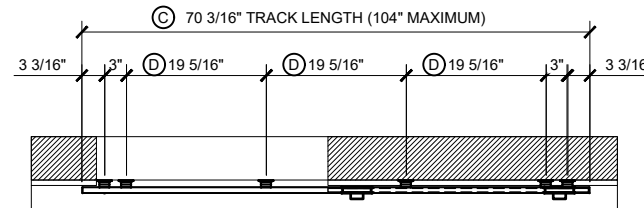

2A PLAN

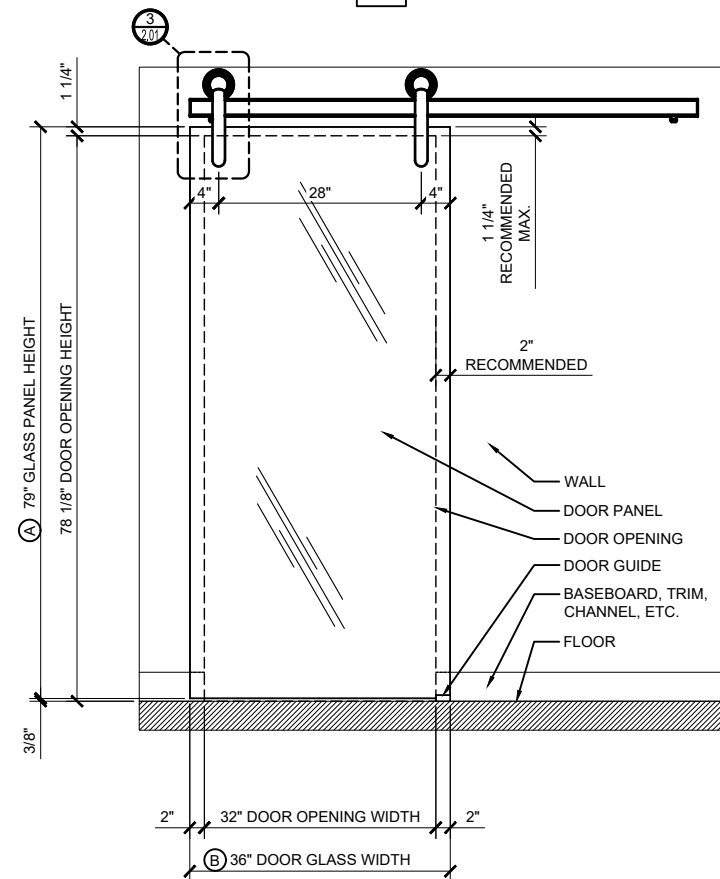

1B ELEVATION

1 SOLSTICE SERIES DOOR (CLOSED)
 ARCH REF: NONE 1"=1'-0"

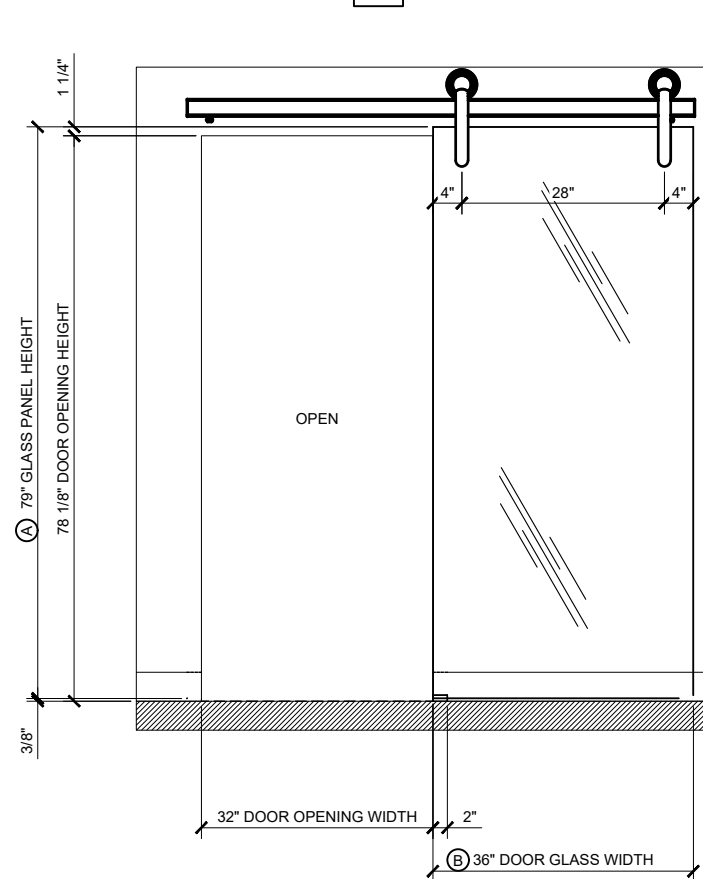

2B ELEVATION

2 SOLSTICE SERIES DOOR (OPEN)
 ARCH REF: NONE 1"=1'-0"

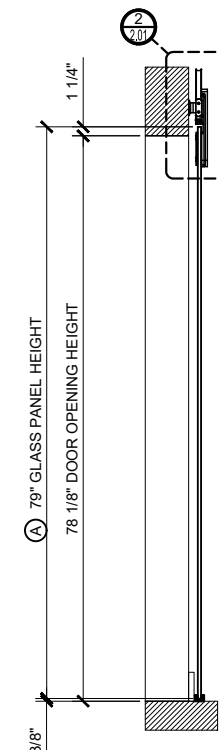

3 SECTION
 ARCH REF: NONE 1"=1'-0"

- (A) D.O.H. + 7/8"
- (B) D.O.W. + 4"
- (C) (D.O.W. x 2) + 6-3/16"
- (D) ((C) - 12-3/8") / 3

D.O.H. = DOOR OPENING HEIGHT
 D.O.W. = DOOR OPENING WIDTH

Description:

CRL SOLSTICE
 SLIDING DOOR

Drawn By: RPD

Date: 3/19/24

Scale: AS NOTED

File Name:
 SYS-0132C_Solstice_Sliding_Door.dwg

Sheet

CRL SOLSTICE SLIDING DOOR ON GLASS WALL

DOOR SYSTEM LIMITATIONS
 MAXIMUM GLASS PANEL WEIGHT: 550 lbs. (249.5 kg)
 MAXIMUM TRACK LENGTH: 16 ft. (305mm)
 FOR 1/2" (12.7mm) TO 3/4" (19mm) TEMPERED GLASS

- * TESTED TO 1,000,000 CYCLES
- * ADJUSTABLE DOOR STOPS
- * ADJUSTABLE TRACK HEIGHTS
- * 1/4" (6.3mm) BI-DIRECTIONAL TRACK LEVELING
- * ANTI-LIFT SAFETY MECHANISM
- * BLACK STAINLESS AND BRUSHED STAINLESS FINISHES

Revisions By:

CRL

C.R. LAURENCE CO. ARCHITECTURAL PRODUCTS
 2503 E. Vermont Avenue, Los Angeles, CA 90058-1897
 PH (800)-421-6144 FX: 800-587-7501 www.crlaurence.com

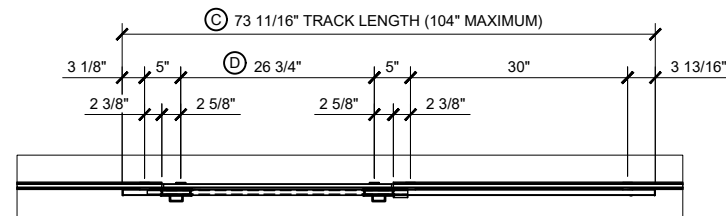

1A PLAN

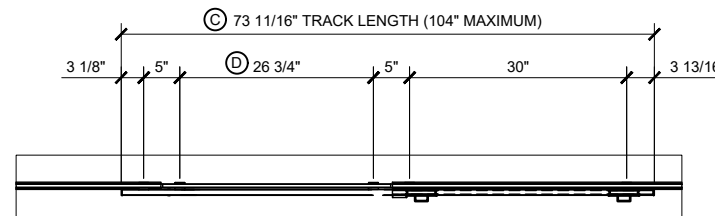

2A PLAN

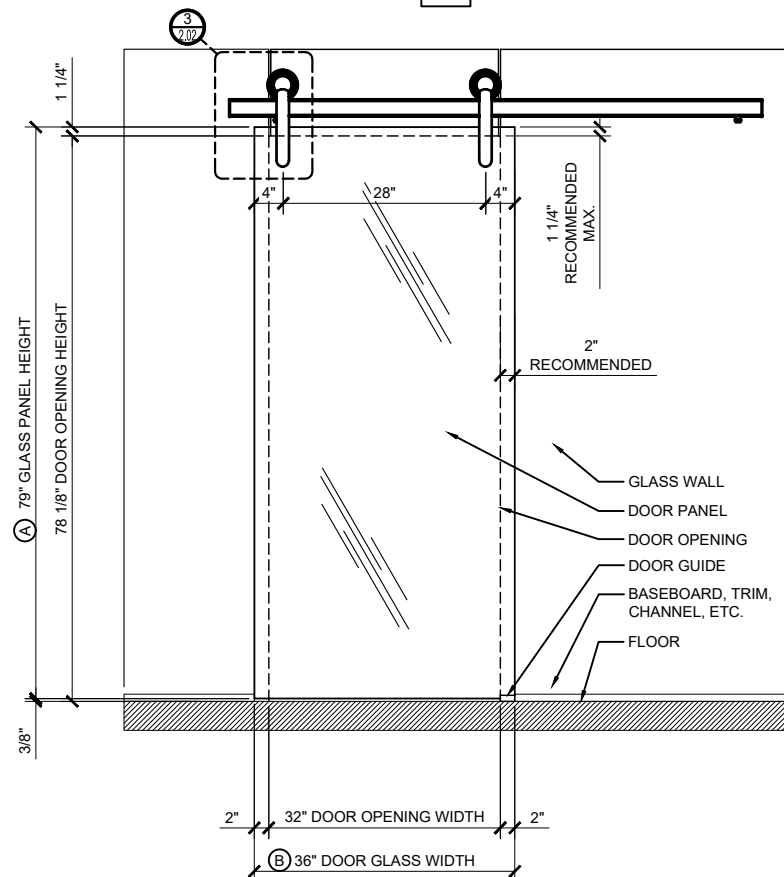

1B ELEVATION

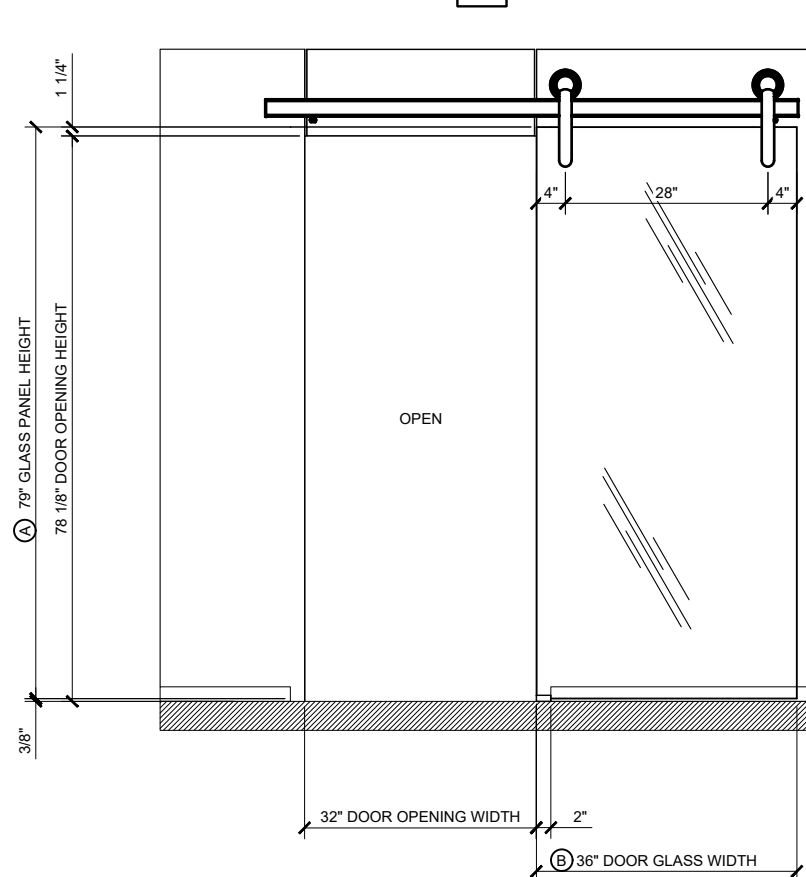

2B ELEVATION

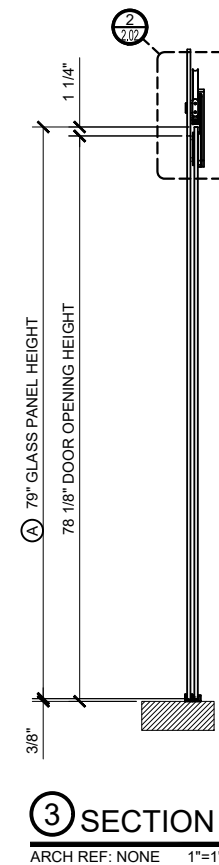

3 SECTION
 ARCH REF: NONE 1"=1'-0"

1 SOLSTICE SERIES DOOR (CLOSED)
 ARCH REF: NONE 1"=1'-0"

2 SOLSTICE SERIES DOOR (OPEN)
 ARCH REF: NONE 1"=1'-0"

- (A) D.O.H. + 7/8"
- (B) D.O.W. + 4"
- (C) (D.O.W. x 2) + 9-11/16"
- (D) D.O.W. - (2-5/8" X 2)

D.O.H. = DOOR OPENING HEIGHT
 D.O.W. = DOOR OPENING WIDTH

Description:

CRL SOLSTICE
 SLIDING DOOR

Drawn By: RPD
 Date: 3/19/24
 Scale: AS NOTED
 File Name: SYS-0132C_Solstice_Sliding_Door.dwg

Sheet

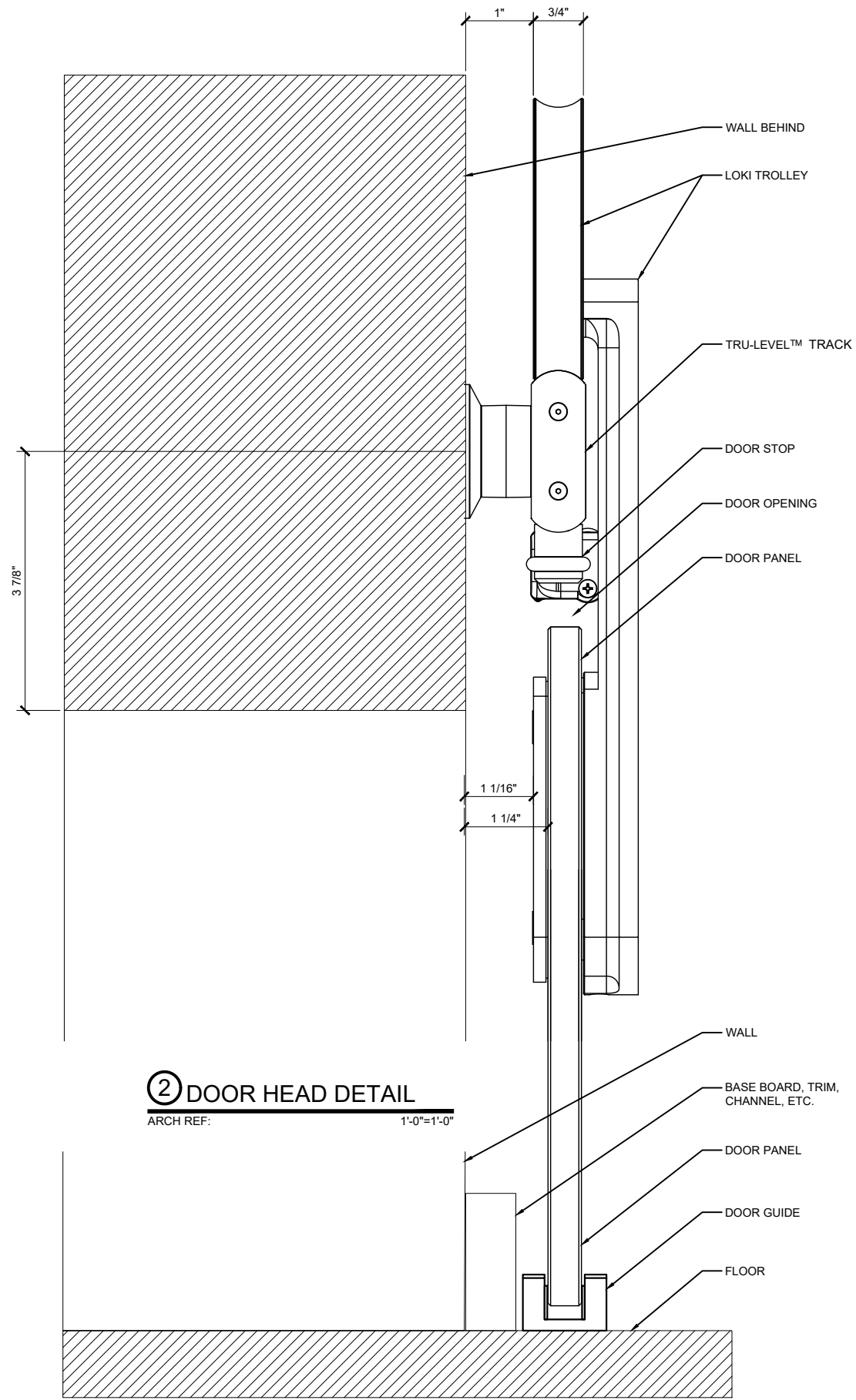

2 DOOR HEAD DETAIL

ARCH REF: 1'-0"=1'-0"

1 DOOR SILL DETAIL

ARCH REF: 1'-0"=1'-0"

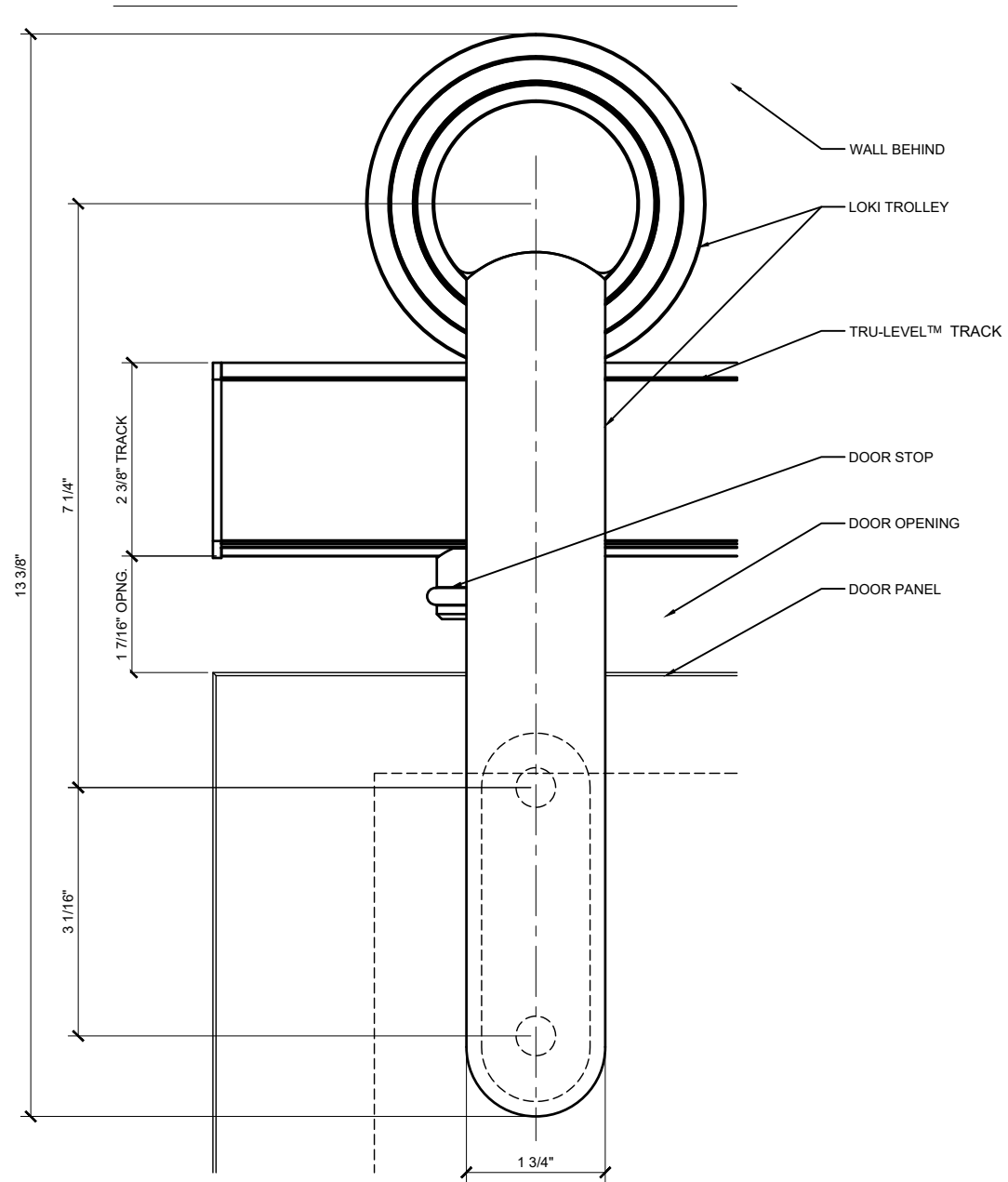

3 DOOR SLIDER ELEVATION

ARCH REF: 1'-0"=1'-0"

Revisions By:

CRL.

C.R. LAURENCE CO. ARCHITECTURAL PRODUCTS
 2503 E. Vernon Avenue, Los Angeles, CA 90058-1897
 PH (800)-421-6144 FX: 800-587-7501 www.crlaurence.com

Description:

CRL SOLSTICE
 SLIDING DOOR

Drawn By: RPD

Date: 3/19/24

Scale: AS NOTED

File Name:
 SYS-0132C_Solstice_Sliding_Door.dwg

Sheet

2.01

Revisions By:

CRL.

C.R. LAURENCE CO. ARCHITECTURAL PRODUCTS
2503 E. Vernon Avenue, Los Angeles, CA 90058-1897
PH (800)-421-6144 FX: 800-587-7501 www.crlaurence.com

Description:

CRL SOLSTICE
SLIDING DOOR

Drawn By: RPD
Date: 3/19/24
Scale: AS NOTED
File Name: SYS-0132C_Solstice_Sliding_Door.dwg

Sheet

2.02

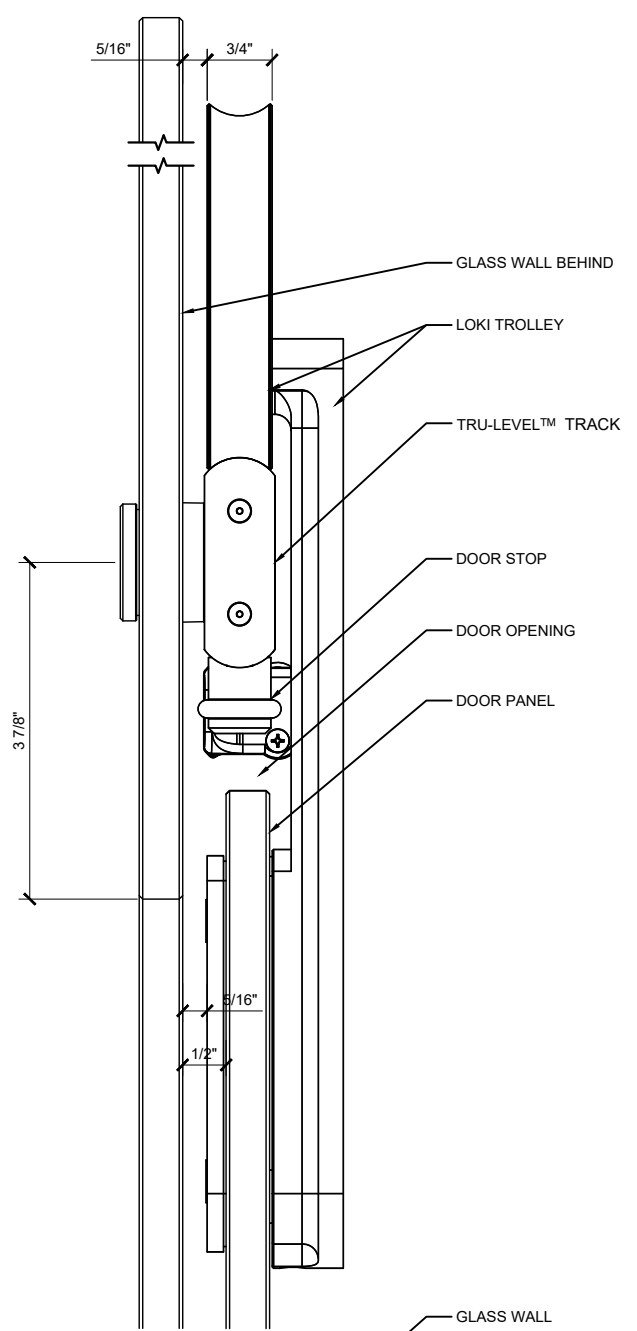

② DOOR HEAD DETAIL
ARCH REF: 1'-0"=1'-0"

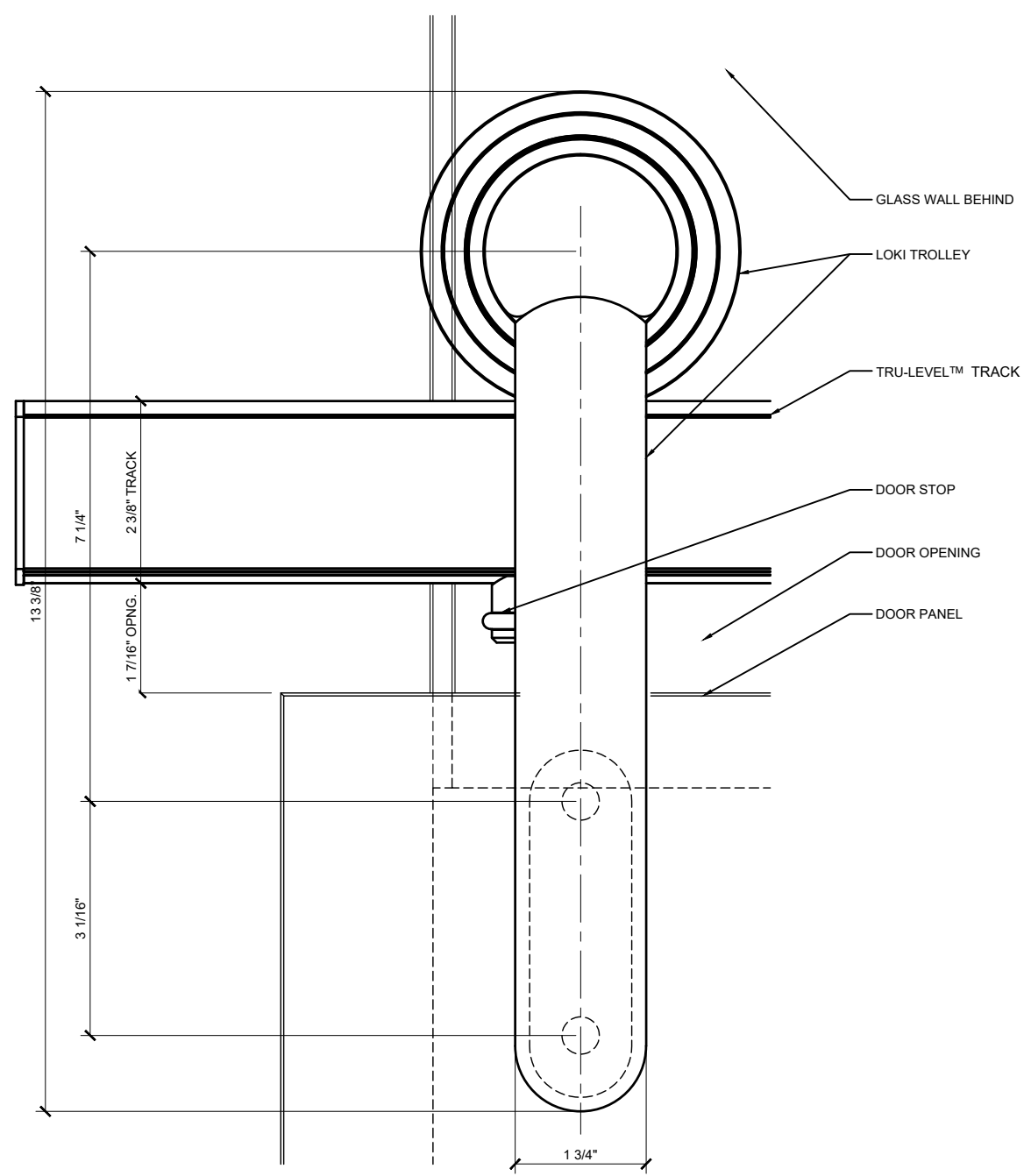

③ DOOR SLIDER ELEVATION
ARCH REF: 1'-0"=1'-0"

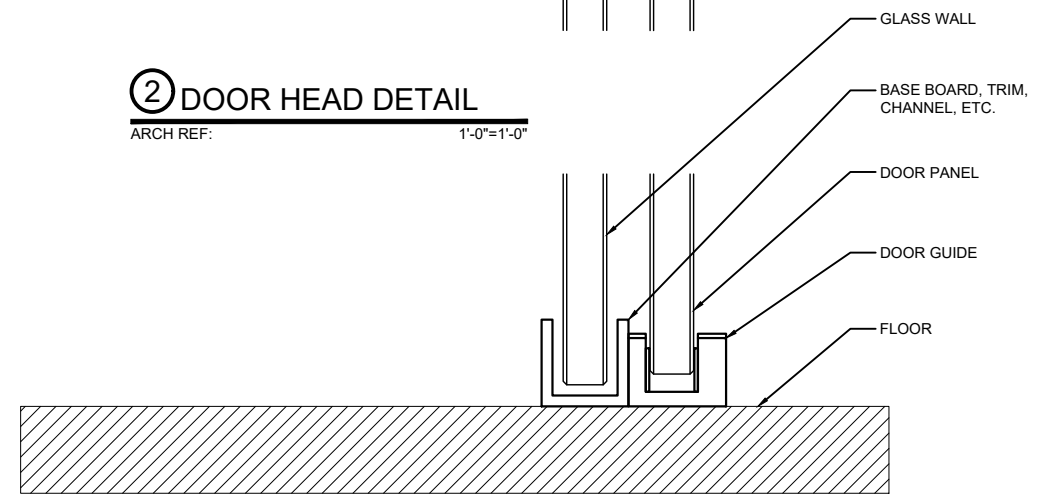

① DOOR SILL DETAIL
ARCH REF: 1'-0"=1'-0"