

“BARBARA”

MODELS D1029 & D1030

INTERIOR USE ONLY

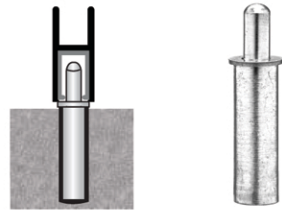
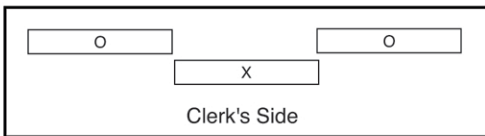
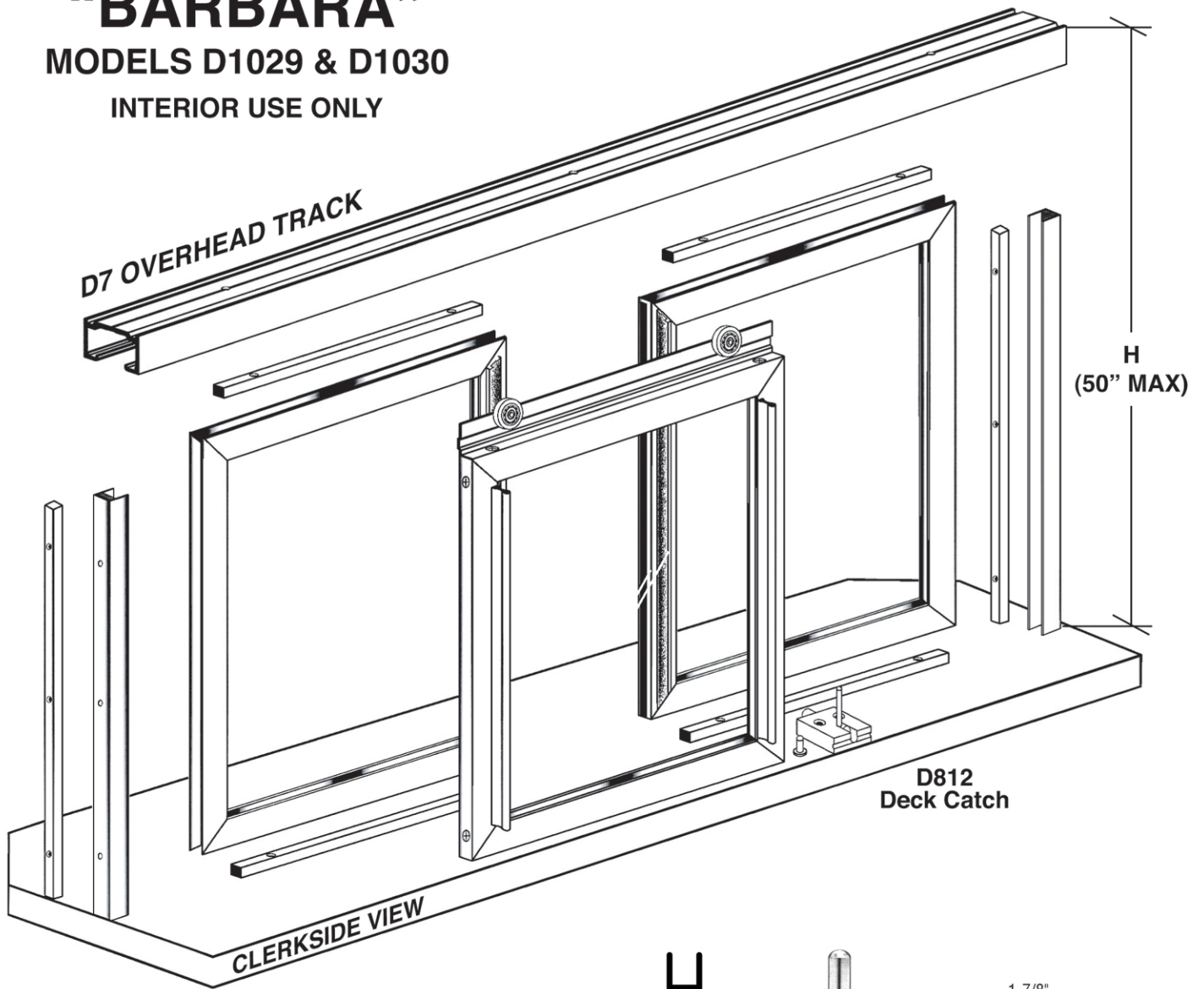

SPRING-LOADED D35 GUIDE

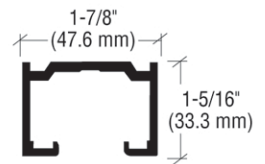

STANDARD D7 OVERHEAD TRACK
SPECIFY D1029 ASSEMBLY

OPTIONAL KEYED LOCK

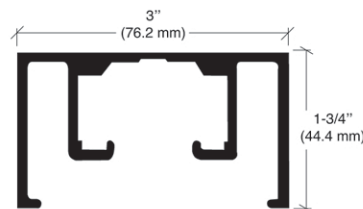
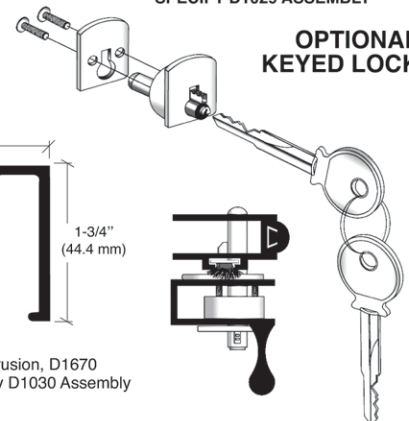

D1670 OVERHEAD TRACK
When Matching a Store Front Extrusion, D1670 Upper Track may be used. Specify D1030 Assembly

CRL Frame Corners With Screws

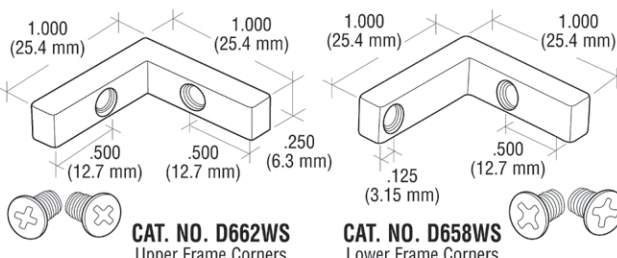

AVD0958, Barbara, 1029&1030 WEB