

GRS GLASS RAILING DRY GLAZE TAPER-LOC® X SYSTEM



GRS GLASS RAILING DRY GLAZE TAPER-LOC® SYSTEM*
FOR TEMPERED GLASS APPLICATIONS
 Installation Instructions

*U.S. Patent Numbers 8,122,654 & 8,201,366 and Commonwealth of Australia Patent No. 2008207524

See the video at crlaurence.com

TAPER-LOC[®] X
 DRY GLAZE RAILING SYSTEM

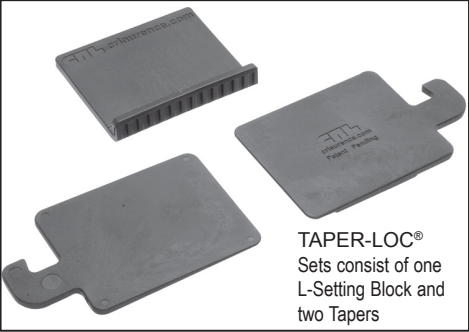

- For Interior and Exterior Railing Applications
- For 1/2" (12 mm) 5/8" (15 mm) and 3/4" (19 mm) Monolithic Tempered Glass Railing Applications (Not Designed for Use With Laminated Glass)
 Use CRL LTL10X1 for Laminated Applications
- Supports Surface Mount, Embed Mount, and Fascia Mounting Methods
- Designed for Typical Concrete and Steel Mounting Substrates
- Tested and Engineered to Meet and Exceed Code Standards
- Reduces Installation Labor Time by 50%
- Designed for Residential or Commercial Applications

CAT. NO.	DESCRIPTION
TL5X10	TAPER-LOC® 'X' Set for 1/2" (12 mm) (15 mm) and 3/4" (19 mm) Glass

Minimum order: 10 sets.

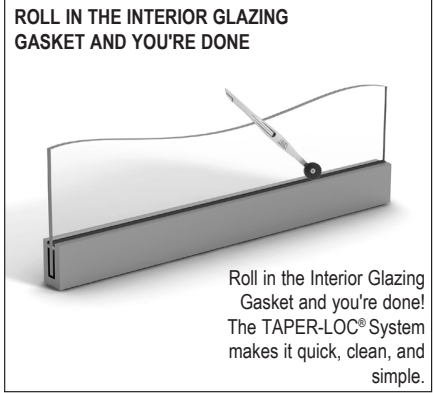
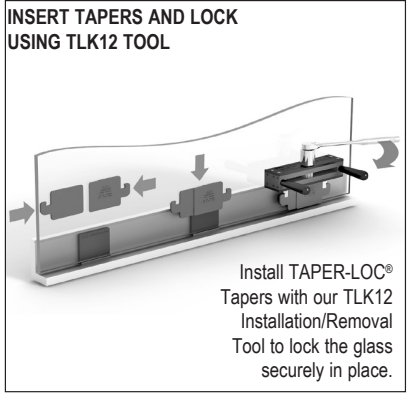
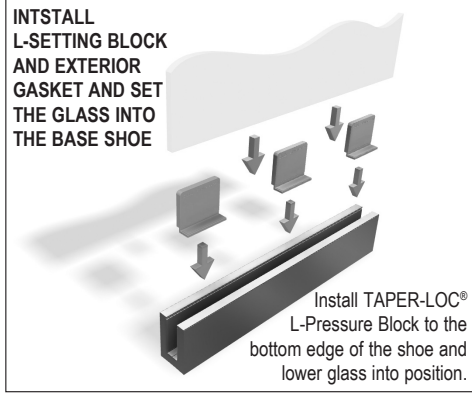

TOOLS REQUIRED FOR INSTALLATION

<p>CAT. NO. TLK12 INSTALLATION/REMOVAL TOOL KIT</p>	<p>CAT. NO. PAL1K PAL TOOL KIT</p>	<p>CAT. NO. EBAD2 MASONRY DRILL</p>	<p>CAT. NO. EBADP1 HOLE BLOW OUT TOOL</p>	<p>CAT. NO. HRHD1 ROTARY HAMMER DRILL</p>	<p>CAT. NO. 7716H IMPACT SOCKETS</p>
<p>CAT. NO. VR04 VINYL ROLLER TOOL</p>	<p>CAT. NO. 54225 TAPE RULE</p>	<p>CRL's TAPER-LOC® tools give the installer the ability to accurately shim, plumb, and install the glass rail system quickly. Proper alignment of the Base Shoe is a key element in making sure the system gets installed plumb and level. See our informative installation video at crlaurence.com. For technical assistance contact Railing Technical Sales at (800) 421-6144 and ask for Ext 7730.</p>			



TAPER-LOC® Tapers:

High strength reinforced nylon Taper Shims expand in thickness when compressed together with the TLK12 Installation/Removal Tool, mechanically locking the glass panel into the Base Shoe. The Installation/Removal Tool will also loosen the Tapers for glass panel alignment or replacement by separating the Tapers.



TAPER-LOC® L-Setting Block:

High strength reinforced nylon "L" shaped Block spaces the glass away from the Base Shoe's vertical wall on one side and the bottom edge. Blocks are installed into the base shoe. Blocks serve to insulate the glass panels from damage during insertion into the Base Shoe, and at the same time center the glass in the pocket. Blocks are black in color.

NEW

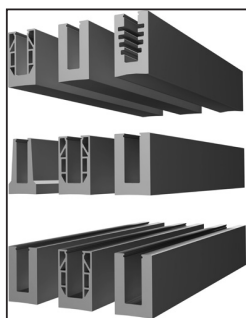

Heavy Aluminum Base Shoe:

High Strength extruded Aluminium Base Shoe is pre-drilled to facilitate installation into various substrates. You can use TAPER-LOC® with our 8B, B5S, B5A, B5T, 8B58, B6N, B6S, 8B34 and B7S Base Shoes for 1/2" (12 mm), 5/8" (15mm) or 3/4" (19 mm) glass. Standard lengths are 10' and 20' (3.05 and 6.10 m). Custom lengths can also be made available on special order. Accessories include cladding and end caps, shims and roll-in gasket. Go to our web site and search BASE SHOE for the complete selection. **Important!!! Base Shoe used with the TAPER-LOC® System must meet the following glass receiving pocket width dimensions and tolerances:**

For 1/2" (12 mm) glass the pocket width must be 1.00" + 0.00" or - 0.020"

For 5/8" (15 mm) glass the pocket width must be 1.125" + 0.00" or - 0.020"

For 3/4" (19 mm) glass the pocket width must be 1.25" + 0.00" or - 0.020"



Base Shoe Cladding and End Caps:

Our thorough selection of accessories includes everything you need for the installation of finished railing systems: Base Shoe Cladding, End Caps, Fasteners, Shims, and Vinyl; Hand Railing Tubing, Brackets, and Joiners in your choice of many beautiful architectural finishes. Go to our web site and click on the HR11 Railing Systems Catalog to begin your review of our entire program.



Base Shoe Anchor Bolts:

When mounting the GRS Glass Railing Base Shoe to a concrete substrate use CRL's **Cat. No. EBA334, WBA38X4 or WBA10X4SS** HSL-3 Heavy-Duty Sleeve Expansion Anchors. When mounting the Base Shoe to a steel substrate use CRL's **Cat. No. SHCS12X34 or SHCS12X1** Socket Head Cap Screws for attachment. Anchor Bolts have been engineered and tested to meet guardrail code requirements.

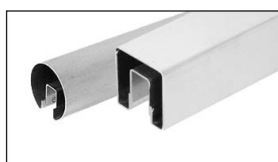

Top Cap Rails:

Our Premium Cap Rails are available in diameters from 1-1/2" to 4" (38 to 102 mm). New Square Profile Cap Rails come in sizes from 1-1/2" to 2-1/2" (38 to 63 mm). Precision tooling and finishing techniques assure you a Cap Rail of unsurpassed quality. Accessories include Splicing Sleeves, Elbow Joints, End Caps, Installation Vinyl, and Metal Contact Cement for almost seamless joints. Go to our web site and search CAP RAILS for the complete selection.



Hand Rail Tubing and Brackets:

CRL's Round Hand Rail Tubing is sold in diameters from 1-1/2" (38.1 mm) to 2" (50.8 mm). Square Hand Rail Tubing is also available in a 1-1/2" (38.1 mm) profile. Hand Rail Brackets and accessories are also available in five architectural finishes. Hand Rail Tubing is sold in 20' (6.10 m) lengths.

STANDARD SYSTEM COMPONENTS



NEUTRAL CURE SILICONE



HAND RAIL BRACKETS



SPLICE SLEEVES

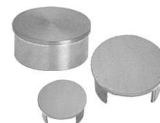

CAP RAIL END CAPS



METAL CONTACT CEMENT

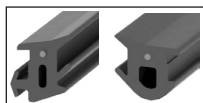

NEW SAFETY SEALS FOR MONOLITHIC GLASS

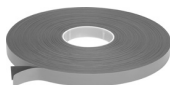

CLADDING TAPE

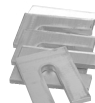

ALUMINUM HORSESHOE SHIMS



ALUMINUM SHIM STRIPS

1. Substrate Preparation

Base Shoe Attachments to Concrete

Start by using the holes in the Base Shoe as an alignment fixture for proper hole positioning. Then drill using a Rotary Hammer with the recommended Masonry Drill Bit from table above. If re-bar obstruction occurs, additional drilling of Base Shoe may be required. After drilling, all that is necessary is to clean out the holes with the Blow-Out Pump (**Cat. No. EBADP1**) and install the Expansion Bolt Anchor (Cat. No. EBA334). Expansion Bolt Anchors include a 3/4" diameter washer.

Step 1

Align the Base Shoe in the proper location and drill the required holes in the concrete.



Step 2

Clean out the holes with CRL's Blow Out Pump **Cat. No. EBADP1**.

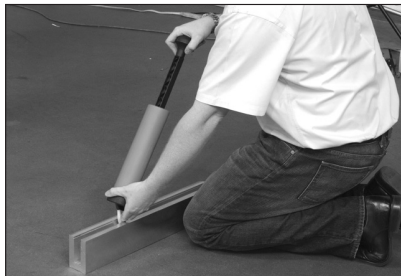

Step 3

Install CRL's Expansion Bolt Concrete Anchors.



Base Shoe to Steel Angles, Channels, and Weld Blocks

Start by using the holes in the Base Shoe as an alignment fixture for proper hole positioning. Then drill the holes in the steel and tap for the 1/2"-13 Socket Head Cap Screw (Cat. No. SHCS12X34). After drilling, all that is necessary is to clean out the holes with the Blow Out Pump (**Cat. No. EBADP1**) and install the Socket Head Cap Screws. If pre-drilled and tapped, Weld Blocks (**Cat. No. BSWB12**) are required, it is recommended that the Weld Blocks be installed to an adequate steel structure by qualified welders. A continuous 3/16" weld must be applied to opposite sides of the Weld Block minimum to meet required loads. The images below illustrate a Weld Block installation.

Step 1

Align the Base Shoe in the proper location, then mark your attachment hole locations. Field weld CRL's pre-drilled and tapped Weld Blocks to the steel stringer.

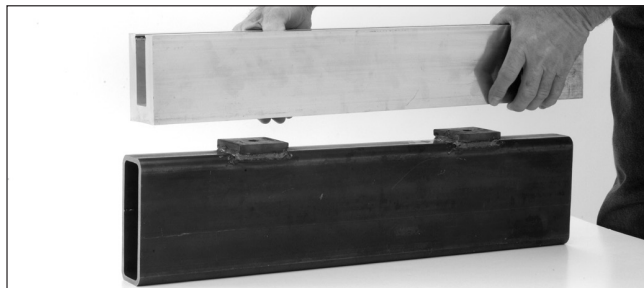

Step 2

Set Base Shoe in place, making sure the Base Shoe hole locations match the Weld Block hole locations.

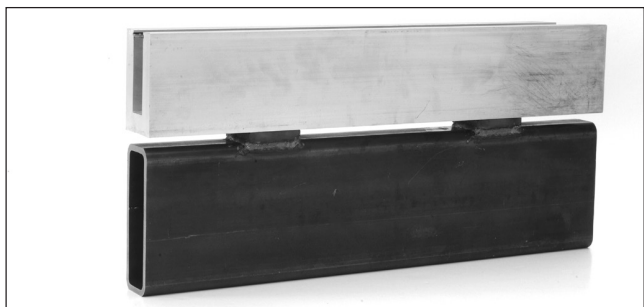

Step 3

Attach the Base Shoe to the Weld Blocks with CRL's 1/2"-13 Socket Head Cap Screws.



Step 4

Tighten each Socket Head Cap Screw until you achieve between 40-44 foot pounds of torque in a Clean and Dry condition.



Preparation

IMPORTANT!!! On all installations the mounted base should be adjusted, if required, to assure it is plumb to plus or minus 1/8" (3 mm) at an extended height of 42" (1067 mm). Spend the time required to plumb the Base Shoe to this tolerance, as the glass will only be as plumb as the Base Shoe.

Available Shims for Leveling the Base Shoe:

CRL Cat. No. AHS66 1/16" x 3" Aluminum Horseshoe Shims
 CRL Cat. No. AHS68 1/8" x 3" Aluminum Horseshoe Shims
 CRL Cat. No. AHS64 1/4" x 3" Aluminum Horseshoe Shims

CRL Cat. No. BSS164 1/64" Aluminum Shim Strips
 CRL Cat. No. BSS132 1/32" Aluminum Shim Strips
 CRL Cat. No. BSS116 1/16" Aluminum Shim Strips



Horseshoe Shims

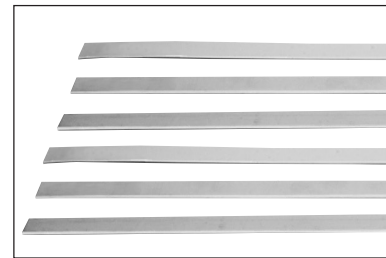

Shim Strips

Layout and Leveling Procedure

Layout the Guardrail or Windscreen perimeter on the mounting surface with a chalk line. Position the first section of Base Shoe, starting at the beginning of a run or at a corner, and align with the chalk line mark. If the installation requires that the Base Shoe be level (as opposed to following the slope of the surface) the first section to be installed should be located at the highest elevation. Start by installing all mounting fasteners hand tight, and then loosen the fasteners for insertion of leveling shims.

Level Base Shoe Installations

When the Base Shoe is to be level, as opposed to following the slope of the surface, it is easier to level the shoe along its length before correcting the vertical plumb orientation.

Sloped Base Shoe Installations

When the Base Shoe is following a sloping grade the "Pal" Digital Laser Tool **Cat. No. 406065** can still be useful for preventing any abrupt elevation changes, and it is easier to level the shoe along its length before correcting the vertical plumb orientation.



Align the "PAL" Digital Laser Tool **Cat. No. 406065** with Base Shoe and point toward the Laser Target set at other end of Base Shoe.



Laser light pinpoints on Laser Target **Cat. No. LT1**.

When leveling the Base Shoe to your concrete or steel substrate make sure you level the shoe within 0.4 degrees of the floor. Angular variation up to 0.4 degrees is acceptable during this process. As you tighten the anchor bolts every 12 inches on center, slide the digital level along the Base Shoe making sure the shoe is within specification. If adjustments need to be made loosen the anchors bolts and shim as required using CRL's Aluminum Horse Shoe Shims or Shim Strips until your Base Shoe is within spec. Proper alignment of the Base Shoe is a key element in making sure the system gets installed plumb and level. Insert shims when mounting surface conditions create occasional gaps under the Base Shoe. CRL Aluminum Horseshoe Shims up to 1/4" (6.3 mm) thick can be used. Good surface conditions will permit the use of CRL Aluminum Base Shoe Shim Strips. The Shim Strips are available in thicknesses of 1/64" to 1/16" (.4 to 1.6 mm), and allow for fine adjustment of vertical plumb. After leveling both ends of a Base Shoe section, place shims at ALL BOLT LOCATIONS where gaps between the Base Shoe and mounting surface appear. Both sides of the Base Shoe must be in contact with the mounting surface or shims before tightening bolts, or the Base Shoe will twist out of vertical plumb alignment. Shim Strips should be oriented along the length of the Base Shoe and must be close to the outer edge. The bottom surface of CRL Base Shoe or CRL Windscreen Base Shoe is concave to prevent "high centering", so the outer bottom edges must be in contact with the shims.



Slide Shim Strips under Base Shoe to fill gaps.



Use the "PAL" Tool to assure the Base Shoe is level at all points. When leveling the Base Shoe make sure you level the shoe within 0.4 degrees of the floor. Angular variation up to 0.4 degrees is acceptable during this process.

Using the GRS PAL Digital Locator

Assemble the Alignment Adapter onto the digital device by aligning the thread in the Alignment Adapter with the thread on the bottom of the digital device. Hand-tighten the thumbscrew, being careful that the digital device is seated flat against the Alignment Adapter. The large pin protruding from the Alignment Adapter must be positioned at the center of the PAL Digital Locator, so please pay attention to the Alignment Adapter orientation that best centers the pin. Push the power button and the PAL is ready for use. Please perform the Self-Check and Calibration Procedure as described at the end of this document.

Before placing the PAL on top of the Base Shoe, wipe the Base Shoe's top surface clean. The accuracy of the level depends on a smooth, clean surface and a balanced PAL with both top surfaces of the Base Shoe in contact with the PAL.

Insert the PAL Alignment Adapter pin into the Base Shoe's pocket with the length of the PAL in line with the length of the Base Shoe for horizontal leveling, or perpendicular to the Base Shoe for vertical plumb adjustment. Start with the horizontal leveling orientation and perform the end-to-end shimming procedure. The display will indicate with two arrows the direction that the PAL needs to rotate for obtaining plumb or level. The PAL has two displays. The left hand display is for leveling, and the right hand display is for indicating angles with the protractor arm.

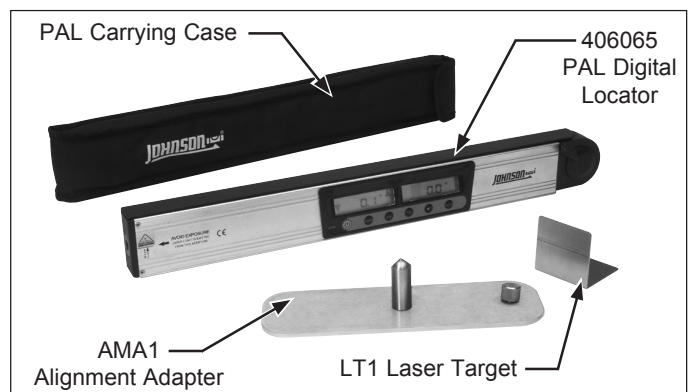
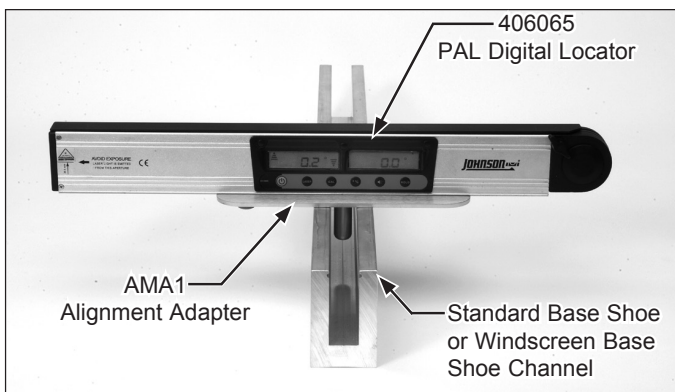

Correcting Out of Plumb

The mounted base should be adjusted, if required, to assure that it is plumb to plus or minus 1/8" (3.2 mm) at an extended height of 42" (1067 mm). To accomplish this the angle indication display must read from one end of the Base Shoe to the other within 0.4 degrees. Angular variation up to 4/10 of a degree is acceptable if the variation from one Base Shoe to the next is leaning to the same side of vertically plumb. With the PAL oriented perpendicular to the Base Shoe, take a reading at three or four locations along the Base Shoe's length, inserting shims as you go along.

Shim Thickness Selection

4/10 of a degree equals 5/16" (8 mm) out of position at 42" (1067 mm) above the mounting surface. When installing CRL 4" (102 mm) tall Base Shoe, insertion of a 1/64" (.4 mm) thick Shim Strip will move the 0.4 reading back to zero. Tighten the mounting bolts to the correct torque, and then double check the vertically plumb orientation.

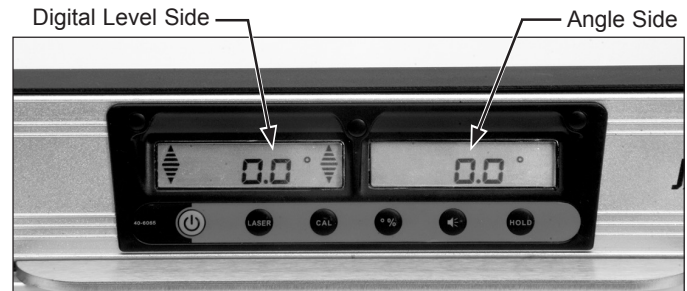

Display for Digital Level and Angle Locator.

Horizontal Leveling

Starting with the first Base Shoe segment that is located at the highest elevation, perform the end-to-end leveling operation, and then adjust the vertical plumb orientation. Now place the PAL in line with the Base Shoe's length. Push the LASER button to turn on the laser. AVOID EXPOSURE TO THE LASER LIGHT. Install the next Base Shoe, aligning the top surfaces with the adjacent Base Shoe, and at the opposite end place the laser target on top of the Base Shoe with its targeting line facing the laser source. Shim the Base Shoe until the laser light is centered on the targeting line. Leave the laser on the first Base Shoe to perform this function for all Base Shoe up to a 100 foot (30 m) long run. The PAL can be moved to a previously leveled Base Shoe nearer to the new work area if the run exceeds 100 feet (30 m). Each new run direction should repeat this process. It is undesirable to turn the laser perpendicular to the Base Shoe for leveling of an adjacent run of Base Shoe.

NOTE: THE LASER DOES NOT LEVEL ITSELF, so occasionally check the level angle display as you work.

Following a Grade

The PAL's Laser is not self-leveling, and because of this it is appropriate for use on sloping grades, stairs, and ramps. Adjust the Base Shoe's vertically plumb orientation. Now place the PAL in line with the Base Shoe's length. Push the LASER button to turn on the laser. AVOID EXPOSURE TO THE LASER LIGHT. Install the next Base Shoe, aligning the top surfaces with the adjacent Base Shoe, and at the opposite end place the laser target on top of the Base Shoe with its targeting line facing the laser source. Shim the Base Shoe until the laser light is centered on the targeting line. Leave the laser on the first base shoe to perform this function for all Base Shoe up to a 100 foot (30 m) long run. The PAL can be moved to a previously leveled Base Shoe nearer to the new work area if the run exceeds 100 feet (30 m). Each new run direction should repeat this process. It is undesirable to turn the laser perpendicular to the Base Shoe for leveling of an adjacent run of Base Shoe. Sometimes grades will intentionally ungrade, so it may be necessary to move the laser's location to compensate. The laser's purpose in this application is to avoid abrupt elevation changes that look unsightly.

Using the Angle Locator

The Angle Locator (Protractor Arm) is very useful for making field layout drawings and setting Base Shoe corner angles. Simply loosen the locking screw and unfold the angle locator arm. Match the angle of subject surfaces and read the angle indication from the right hand display. Depressing the HOLD button is useful for retaining the angle information when working blind.



Unfold locator arm.

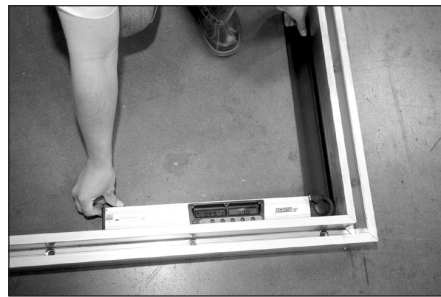

Match angle of subject surface.



Read angle indicator.

3. Prep the Glass for Installation

Before installation of the glass panels the L-Setting Blocks must be adhered onto the base shoe. Remove the tape's liner strip and stick the L-Setting Blocks onto the outside wall of the base shoe pocket. Space at 14" (356 mm) on center maximum or a minimum of 4" for a 48" (1219 mm) glass panel (reference chart on the next page). Exact spacing is not necessary. For small glass panel width conditions at stairways and ramp returns only one L-Setting Block is required.

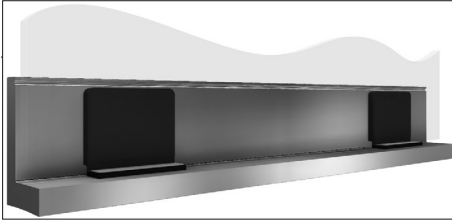

Make sure the TAPER-LOC® spacing does not exceed 14" (356 mm) on center.

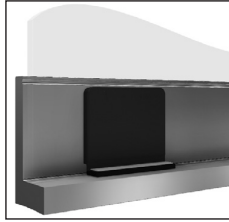

6" (152 mm) edge distance is recommended for most standard applications.

Panel Width

- 6" to 14" (152 to 356 mm)
- 14" to 28" (356 to 711 mm)
- 28" to 42" (711 to 1067 mm)
- 42" to 56" (1067 to 1422 mm)
- 56" to 70" (1422 to 1778 mm)
- 70" to 84" (1778 to 2134 mm)

Required Quantity:

- 1 TAPER-LOC® Set
- 2 TAPER-LOC® Sets
- 3 TAPER-LOC® Sets
- 4 TAPER-LOC® Sets
- 5 TAPER-LOC® Sets
- 6 TAPER-LOC® Sets

SYSTEM FOR 200 LB. (90 KG) POINT LOAD WITH 4X SAFETY FACTOR

**TYPICAL BASE SHOE ELEVATION
DETAIL WITH TAPER-LOC® LOCATIONS**

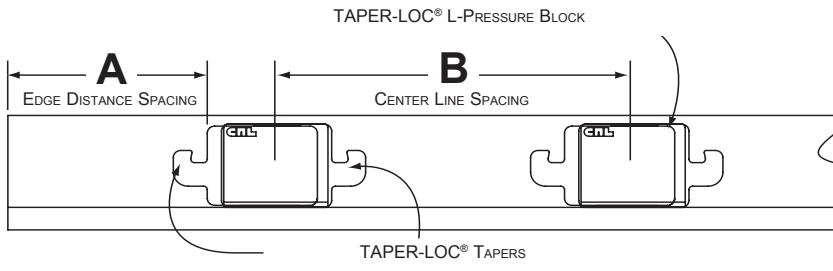

A: The TAPER-LOC® minimum edge distance spacing shall not be less than 2" (51 mm) and no more than 8-5/8" (219 mm) from the edge of glass to edge of the TAPER-LOC® components.

B: The TAPER-LOC® maximum center-to-center spacing shall not be less than 7" (178 mm) and no more than 14" (356 mm) from the center line of the TAPER-LOC® Tapers.

Before the glass is installed into the Base Shoe the installer should insert **Cat. No. SMBSG** Series "Drop-Side" Safety-Seal. CRL's Safety Seal Glazing Vinyl was developed for balcony edge conditions that are difficult to access. Our **Cat. No. SMBSG** Vinyl eliminates the difficulty and risk of reaching over the glass edge to roll in typical glazing vinyl. For more information regarding CRL's Safety Seal System, please visit our web site at crlaurence.com.

4. Glass Panel Installation

To begin the installation of the glass panels, first make sure the Base Shoe is free of debris. Place the glass with the L-Setting Block on the bottom surface of the shoe's pocket. Make adjustments if required. Blocking can be added if one corner of the panel is low. The glass can be held in a near vertical position by inserting one TAPER-LOC® Taper Set at each end of the glass panel.

Important!!! One Taper in each set has "Glass Side" engraved on it. This surface must face and touch the glass panel.

The other Taper has projecting rails along it's length that hold Tapers in alignment with each other. Align the two Tapers and spread them apart until the assembly is thin enough to fit into the slot. Partially insert the Tapers into the slot between glass and Base Shoe, squeeze together with very light finger pressure, and push down into the Base Shoe. This will apply some clamping force and aid with alignment. When the installer is satisfied with the spacing and top height alignment for a group of panels the TAPER-LOC® securing operation may begin.

Step 1

Squeeze the Tapers together finger tight and push the set half way down into the Base Shoe as shown.



Step 2

Use the TLK12 Installation/Removal Tool to push the Tapers down into position for the next step, locking the Tapers together.

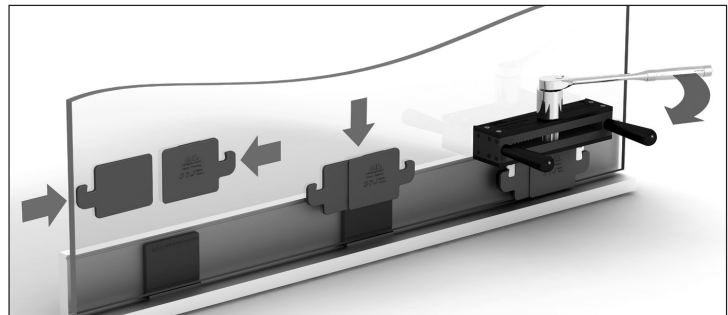

5. Securing the TAPER-LOC® Glass Panels in the Base Shoe

TAPER-LOC® Systems are self-centering and self-plumbing. **Remember the glass will follow the Base Shoe alignment, so spend the time required to plumb the Base Shoe to + or - 1/8" (3.2 mm) at 42" (1067 mm) extended.** Partially insert the remaining TAPER-LOC® Tapers into the slot between the glass and Base Shoe, squeeze together with very light finger pressure, and push down into the Base Shoe. Don't worry about trying to push the Tapers all of the way into the Base Shoe, as the Installation Tool will take care of this for you. **NOTE: The right side of the right hand Taper must be aligned with the right hand vertical edge of the L-Setting Block.**

It is a good idea to lock-up both ends of each panel and double check alignment before locking the Tapers in between. Insert the Installation/Removal Tool's blades into the slot between the glass and Base Shoe. Using the Torque Wrench, bring the blades closer together by depressing the left side ratchet direction button, crank on the wrench or push the torque wrench's right side ratchet direction button to spread the blades apart until they align with the Taper slots. The tool should now be able to drop down until it comes to rest on the Base Shoe. This action will push the remaining Taper depth into the Base Shoe. The top blue surface of the tool has a black indication mark at the right hand side that must be aligned with the right side vertical edge of the L-Setting Block (visible looking through the glass). Sliding the tool left or right will move the Tapers at the same time to achieve alignment. Press the left side ratchet direction button to lock the Tapers together. Then (if you are right handed) position yourself to the left side of the tool, grab the tool's left side handle with your left hand, and crank the Torque Wrench with your right hand, being careful to hold the tool in alignment with the L-Setting Block. When the correct lock-up force is applied the wrench will make a single clicking sound, and will break for a few degrees of rotation.

Important!!! If you are not certain that the wrench made the clicking sound, do not apply more force than the factory pre-set. Unlock the Tapers and lock-up once again. Repeat this process for the remaining Tapers. Over-torquing will eliminate the ability to unlock the Tapers with the Installation/Removal Tool, making glass panel removal very difficult.

Step 1

Place the Installation/Removal Tool into position onto the Tapers and push them down into the Base Shoe.



Step 2

Crank the Torque Wrench until the wrench clicks, letting you know the Tapers are locked to the correct measured torque value requirement. (Continue these steps for each Taper Set)



Make sure the blade movement mechanism of the TLK12 Tool moves freely, and hasn't become filled with dust or debris. Blade mechanisms that are poorly maintained may cause binding during the Taper compression operation, and result in an improper installation with insufficient compression of the Tapers.

6. Cladding and Finishing the Base Shoe

There are various methods of attaching the Cladding to the Base Shoe. All three types shown below will work, but a combination of Cladding Tape and Neutral Cure Silicone (Type C) offers the better of two worlds; the instant bond of the tape along with the speed of application of the silicone and its flexible, durable adhesion.

Type A: Apply three rows of Tape to the vertical edge of the Cladding. Carefully align the Cladding to the Base Shoe and press in place.

Type B: Apply Silicone to the vertical edge of the Cladding. Carefully align Cladding to the Base Shoe and press in place. Use clamps to hold the Cladding in place until the Silicone cures.

Type C: Apply two rows of Tape to the vertical edge of the Cladding, one toward the top and one toward the bottom. Apply the Silicone between the rows of Tape. Carefully align the Cladding to the Base Shoe and press in place.

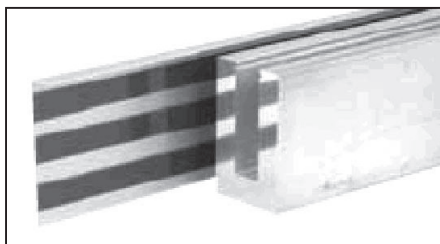

Type A

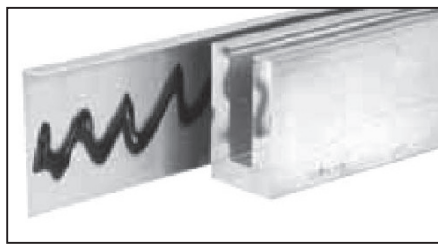

Type B

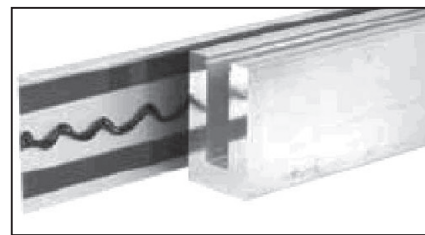

Type C

Once the Cladding is applied the last and final step to finish off the Base Shoe is installing the Roll-In Gasket for interior applications, or to apply CRL's 95CBL Neutral Cure Silicone for exterior applications. We invite you to contact our Railing Technical Sales Division at railings@crlaurence.com to discuss your individual application.

For Interior & Exterior Applications use the Safety Seals: Use CRL's SMBSG and MBSG series Safety Seal for Monolithic Tempered Glass application. Use CRL's SLBSG and LBSG series Safety Seals for Laminated Tempered Glass application to finish off the top of the Base Shoe pocket. The inside Safety Seal easily rolls in with any one of CRL's Vinyl Roller Tools.

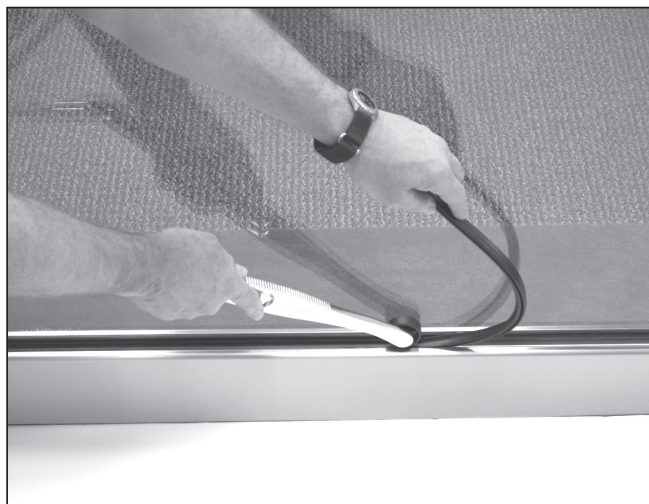
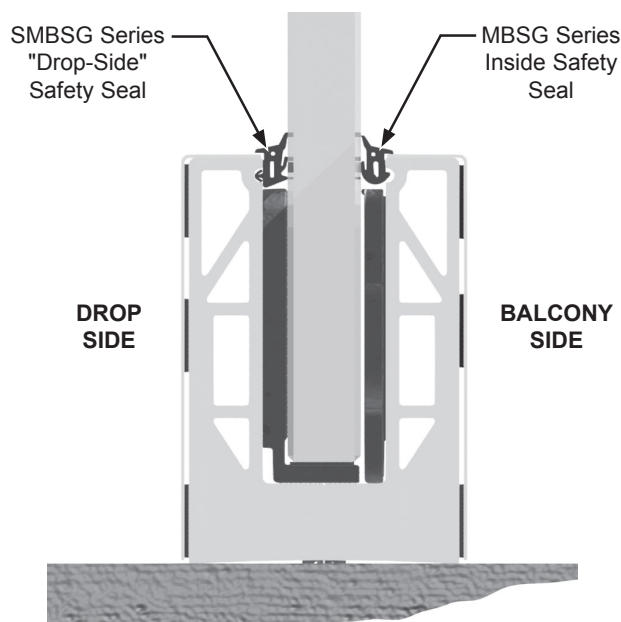

7. Attaching the Top Cap Rail

Apply a continuous bead of **CRL's 95CBL** Structural Silicone to the top glass edge (shown below in Step 1). Secure the protective Vinyl Insert onto glass edge (Step 2), then apply another bead of Structural Silicone to the top edge of the Vinyl Insert (Step 3). The last step is to install the Cap Rail over the Silicone and protective Vinyl Insert until the Cap Rail is firmly seated (Step 4). Shim as required and caulk on both sides at the underside of the glass pocket for a clean finished look.

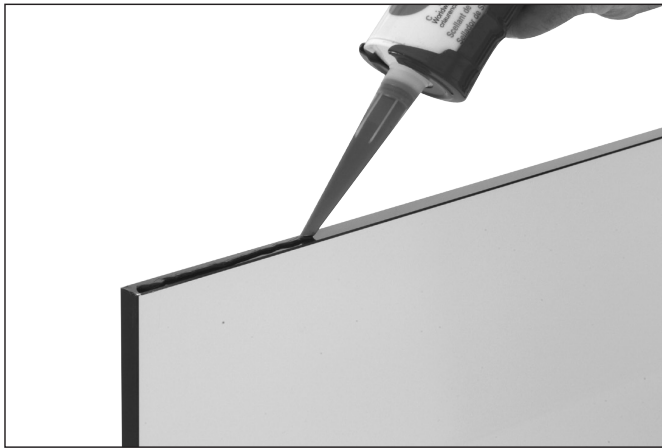

Apply Structural Silicone to the top edge of the glass.

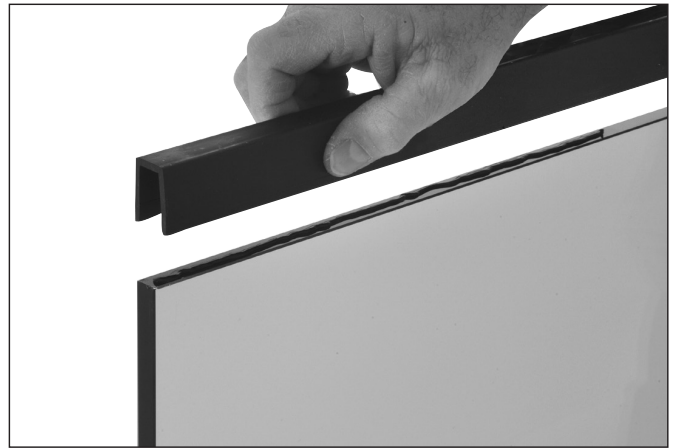

Install the Protective Vinyl Insert.



Apply Silicone to the top edge of the Protective Vinyl Insert.



Install the Cap Rail over the Silicone and Protective Vinyl Insert.

8. Glass Panel Adjustment and Removal

The CRL TAPER-LOC® System only requires the TLK12 Tool for installation and removal of the TAPER-LOC® Taper.



STANDARD INSTALLATION BLADES

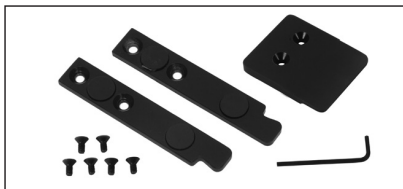

CAT. NO. TLB5 REPLACEMENT BLADES FOR
1/2" (12 MM) OR 3/4" (19 MM) GLASS

EXTENDED BLADES FOR
FASCIA MOUNT CONDITIONS



CAT. NO. TLB6R REPLACEMENT BLADES FOR
1/2" (12 MM) OR 3/4" (19 MM) GLASS

To adjust or remove a glass panel that is already installed, use the standard TLK12 Installation/Removal Tool Kit and follow the steps below. Remember to protect the cladding with **Cat. No. BL992 2" Blue Masking Tape** when removing the TAPER-LOC® Tapers. For glass railing applications insert CRL's TLK12 Installation/Removal Tool over the TAPER-LOC® Tapers you wish to remove or loosen. Once the Installation/Removal Tool is in place, reverse the torque setting and apply force to open the Tapers for adjustment or removal as required. Continue this step as needed for the number of Tapers that need to be adjusted or removed.

Step 1

For adjustment or removal of a glass panel, the **Cat. No. TLK12** Installation/Removal Tool and **Cat. No. BL992 2" Blue Masking Tape** will be required.

Step 1

Apply the 2" Masking Tape to the finished cladded surface to protect it during this removal/adjustment process.



Step 3

Insert the Installation/Removal Tool into position, reverse the torque setting, and apply force to open the Tapers.

Step 4

Complete the process by removing the Tapers from the Base Shoe, then adjust or replace the panel.

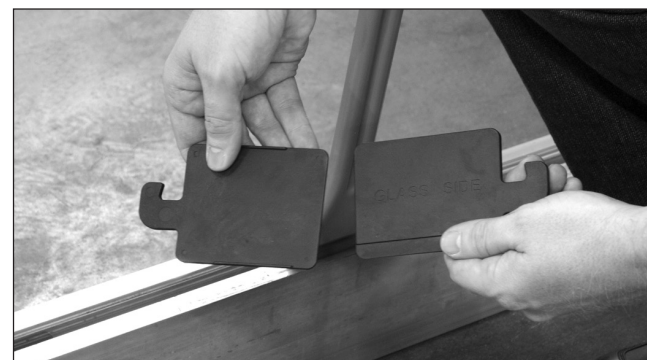

Your comments and suggestions about TAPER-LOC® are always appreciated. If you have some installation tips that you would like to share, contact CRL Railing Technical Sales at (800) 421-6144, Ext. 7730. Send e-mail to railings@crlaurence.com