

C.R. LAURENCE CO. INC

Storm Window System Featuring Universal CRL-Sash

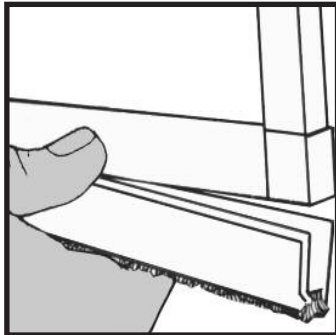

CRL has a complete storm window system designed for interior or exterior installation. It's built around our Universal CRL-Sash, the simple to use storm window frame. That's right, in virtually any application, an easy to do assembly method using CRL-Sash and accessory components results in storm panels that will be tight, secure, functional and durable.

This pamphlet describes the CRL-Sash Storm Window System, along with components that make it the best choice for your customer's storm panel needs.

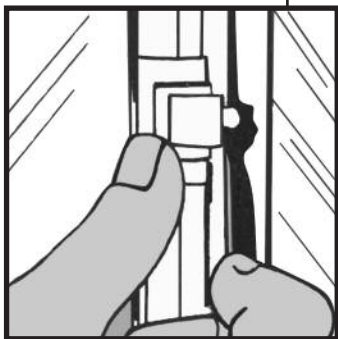

Universal CRL-Sash

*For the Fabrication
of Storm Windows
and Door Panels*

- Available in Mill, White and Bronze Finishes
- Ready for Assembly – Just Measure, Cut, and Insert Corners
- No Adhesive Required to Hold Glass or Acrylic
- Designed for Both Interior and Exterior Application

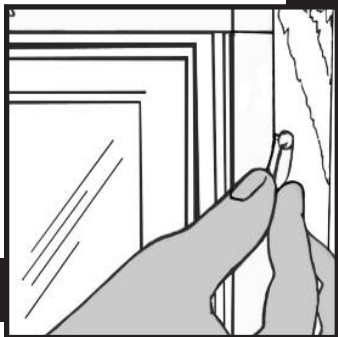
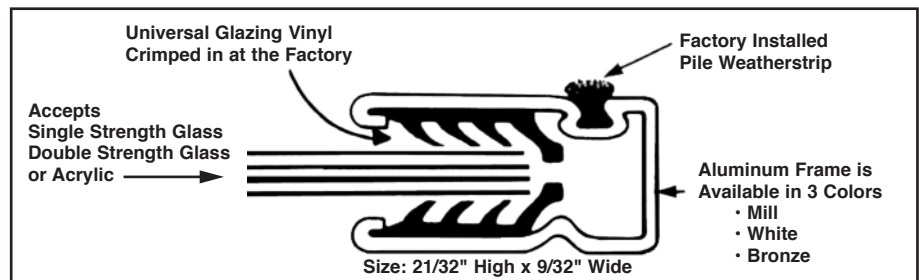
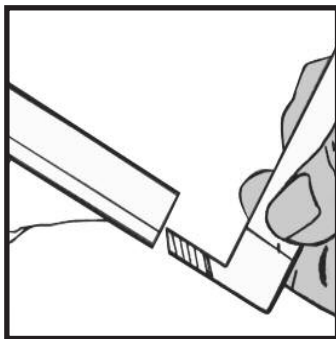
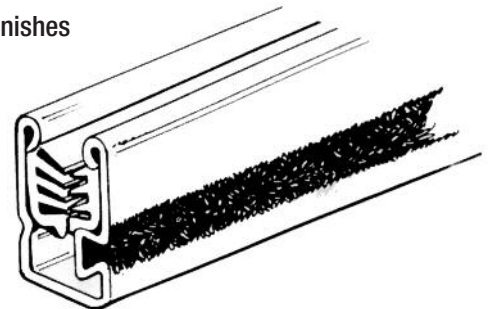

Universal CRL-Sash is a quality-made glass framing material for the fabrication of secure, high-performance storm windows and door panels. Whether your job calls for recessed or surface mounted panels, CRL-Sash frame accepts single strength and double strength glass, or acrylic up to 1/8" thick. The pre-installed vinyl gasketing holds them in without the need for messy adhesives required with most other storm frames. CRL-Sash has built-in pile weatherstripping to help stop air infiltration between the secured panel and window frame. It's roll-formed aluminum body gives it rigidity while being lightweight enough to install and remove seasonally. CRL-Sash is available in three finishes complimentary to building exteriors. All come in standard 12'2" lengths, packed 50 per factory case.

Universal CRL-Sash

CAT. NO.	FINISH
BS1M	Mill
BS1W	White
BS1BRZ	Bronze

DO NOT BE CONFUSED – Universal CRL Sash is U.S.A. manufactured to our own exacting standards, and is not the "C" Sash product produced by Amesbury Industries.



**C.R. LAURENCE
OF NORTH AMERICA**

Phone (800) 421-6144 Ext. 777 • Fax (800) 587-7501 • E-Mail techsales@crlaurence.com

C.R. LAURENCE CO. INC

Installation Instructions

For Storm Panels Made With Universal CRL-Sash

FOR RECESSED, INTERIOR STORM WINDOWS

This is the inside storm window installation for residential use. The panel fits inside the window jamb, held in place by Locking Fasteners. There are no magnetic or plastic support structures remaining when the panel is removed.

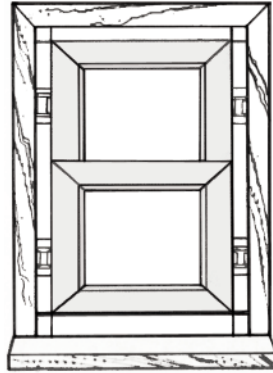

To mount the CRL-Sash in this manner requires a recessed 1/4" internal jamb extension on the original window to provide a weathersealing surface for the panel (see illustration). While most casement and projected windows have this detail, it may have to be added to a double or single hung.

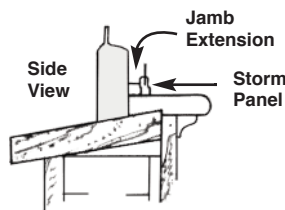
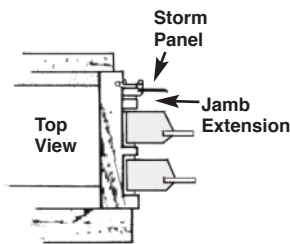

Attach the Locking Fasteners to the vertical members 4" to 5" from the ends and every 12" to 14" between. Snap them into place by hooking one edge over the CRL-Sash at the glass and pressing down the other edge. 6 to 8 Locking Fasteners are required for a typical residential window.

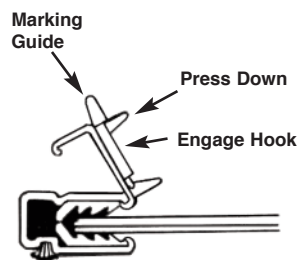

Note: If the panel is wider than 24", Locking Fasteners may be necessary on horizontal members to maintain an efficient seal around the perimeter of the frame.

Mark the locations of the Locking Fasteners on the window jamb and remove the panel. Drill 1/4" holes at each location and insert the brass fittings. Replace the panel and the installation is complete.

FOR SURFACE MOUNTED INTERIOR OR EXTERIOR STORM WINDOWS

If a recessed installation is not possible, the CRL-Sash system makes it possible to mount the panel against the jamb or trim surface.

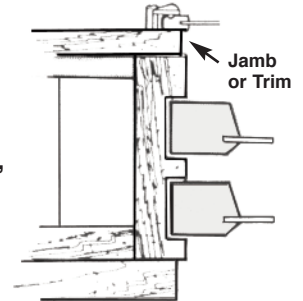

Secure the panel with Storm Window Clamps or Wing Clips to the jamb or trim surface. Be sure the pile weatherstrip is pressed firmly against the jamb or trim surface to block as much air as possible. Loosely fit panels do not work efficiently since approximately 80% of heat or cold air loss occurs through windows. Use Sash Expander where necessary to block air infiltration between panel and sill, pushing pile weatherstrips firmly against sill once panel is in place.

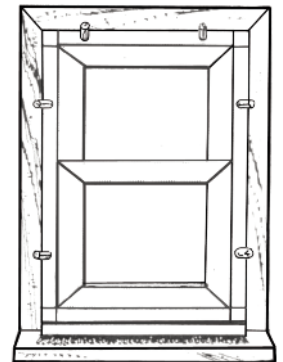

OTHER CRL WINDOW SUPPLIES:

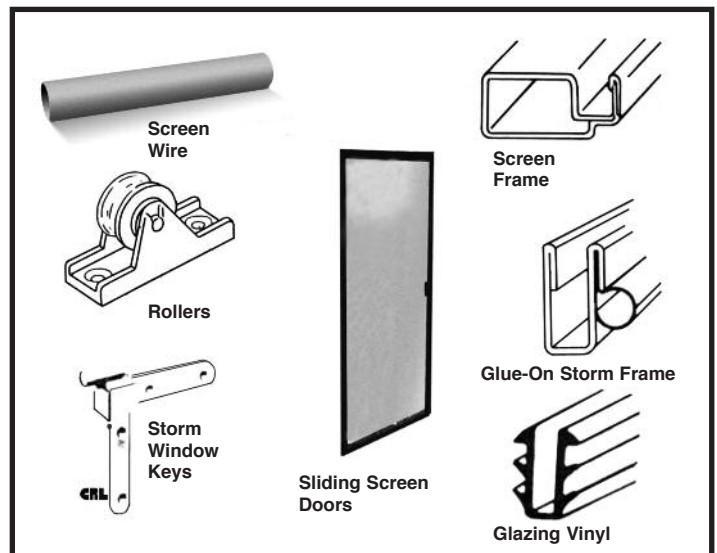

C.R. LAURENCE CO. INC

Installation Instructions For Storm Panels Made With Universal CRL-Sash

CRL-SASH CORNERS

- Two Ways to Fabricate

CRL-Sash Corners are available in molded plastic square sash type or zinc miter cut type to suit your choice of fabrication methods.

Square cut fabrication is accomplished by simply square cutting the Universal CRL-Sash 1-7/16 inch less than the width and height of the desired frame. Next insert the Square Sash Corners, wrap around the glass or acrylic panel, and fabrication is complete.

Note: When inserting the corner into CRL-Sash the locking fins should be opposite the weatherstrip.

Square Sash Corners for Square Cut Fabrication

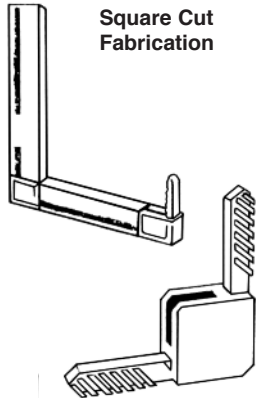

CAT. NO.	COLOR
CD35M	Gray
CD35W	White
CD35BRZ	Bronze

100 per box. Minimum Order: 100 Ea.

Square Sash Corners are made expressly for CRL-Sash, and are not the Press Lock Corners produced by Amesbury Industries.

Miter cut fabrication is accomplished by miter cutting the Universal CRL-Sash to the desired width and height. Next, insert No. 1795 Zinc Corners and wrap around the glass or acrylic panel. Then use the No. S1936 CRL Crimping Tool to crimp the frame onto the dimples in the corners to provide a secure fit.

Zinc Corners for Miter Cut Fabrication

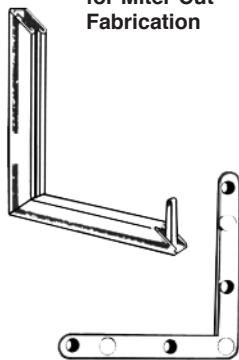

CAT. NO.	DESCRIPTION
1795	Zinc Corners

100 per box. Minimum Order: 100 Ea.

CRL CRIMPING TOOL

- Quick Spring Release
- Adjustable Jaws

The CRL Crimping Tool is designed to crimp the mitered corners of Universal CRL-Sash into the dimples of No. 1795 Zinc Corners in one easy operation.

CAT. NO.	DESCRIPTION
S1936	Crimping Tool



FASTENERS FOR CRL-SASH PANELS

CRL-Sash Panels can be secured using a variety of clamps and clips that will hold them tight in both interior or exterior installations.

CRL SNAP FASTENERS

Made of hardened spring steel plated to resist rust and corrosion, these fasteners use spring tension to stop window rattling because they hold tight, and help save energy by keeping storm windows held snugly in place, reducing heat loss. Two types are available – Regular Fasteners are made to hold wood framed screens and storm windows; Deep Fit Fasteners are designed to compensate for the difference in the thickness of wood window frames and in thin aluminum screen or storm window frames. Packed 144 fasteners per box with screws.

Regular Fastener
Cat. No. F144

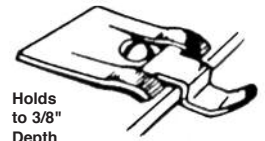

Holds to 3/8" Depth

Deep Fit Fastener
Cat. No. D435



Holds to 3/4" Depth

CAT. NO.	TYPE
D435	Deep Fit Fastener
F144	Regular Fastener

100 per box. Minimum Order: 100 Ea.

CRL STORM WINDOW CLAMPS

Handy exterior clamp set speeds storm window or screen installation. Screw-type clamp gives as much as 3/4" adjustment. Metal screw in threaded hole at bottom of clamp secures to window jamb.

Packaged Four Clamps and Screws

CAT. NO.	COLOR
TDK10BRZ	Bronze
TDK10W	White

Bulk – 50 Sets of Four Clamps and Screws

CAT. NO.	COLOR
TDK1050BRZ	Bronze
TDK1050W	White

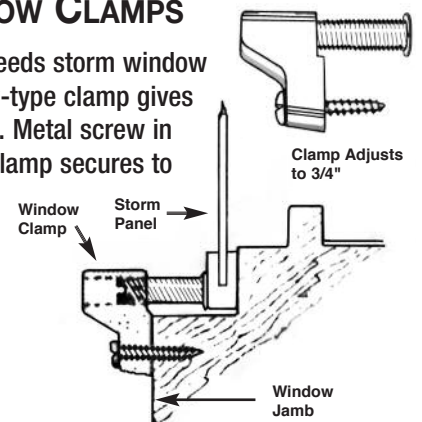

Clamp Adjusts to 3/4"

Window Jamb

CRL WING CLIPS

Wing Clips secure mounted CRL-Sash or other storm panels. Plastic clips resist corrosion and will not rust. 5/16" size clips come in three colors.

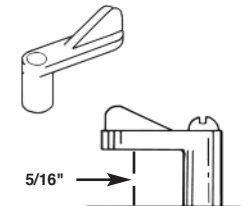

5/16"

CAT. NO.	COLOR
WSC305W	White
WSC305GRY	Gray
WSC305BL	Black

100 per box. Minimum Order: 100 Ea.



C.R. LAURENCE
OF NORTH AMERICA

Phone (800) 421-6144 Ext. 777 • Fax (800) 587-7501 • E-Mail techsales@crlaurence.com

C.R. LAURENCE CO. INC

Installation Instructions

For Storm Panels Made With Universal CRL-Sash

CRL FLUSH CLIPS

For flush mounting of CRL-Sash or other storm panels. Nylon Clips resist rust and corrosion. Use white clips for mill and white CRL-Sash; black clips for bronze CRL-Sash.



CAT. NO.	COLOR
WSC380	White
WSC380BL	Black

100 per box. Minimum Order: 100 Ea.

CRL LOCKING FASTENERS

CRL's Locking Fasteners are the preferred inside storm fastening system that gives a beautiful, professional look to the finished job. The slide bolt inserts into a brass fitting giving positive, reliable attachment. Locking Fasteners are available in colors to match CRL-Sash.

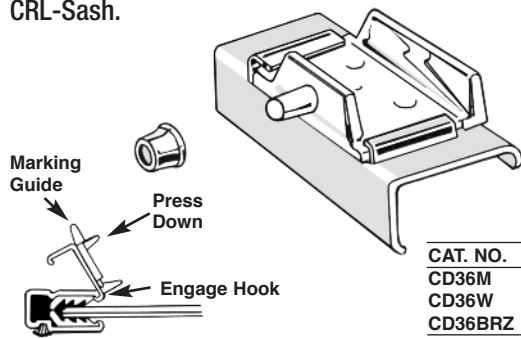

CAT. NO.	COLOR
CD36M	Mill
CD36W	White
CD36BRZ	Bronze

100 per box. Minimum Order: 100 Ea.

CRL SASH EXPANDER

- Seals Sill Opening on Surface Mount Installations
- Built-in Pile Weatherstrip
- Simple Press-on Installation

CRL-Sash Expander is a molded section with built-in pile weatherstrip. It is intended for use to accommodate irregular or slanted windows sills and provide weather sealing at the bottom of the storm panel. Simply press onto bottom of finished panel and trim to fit width of opening

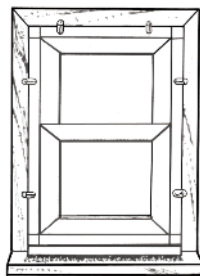
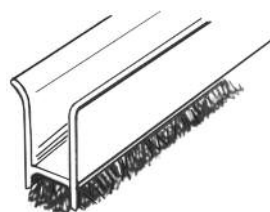

CAT. NO.	COLOR	LENGTH
CD34W	White	42"
CD34BRZ	Bronze	42"

Note: If you plan to use Sash Expander overall dimensions of desired panels must be reduced 5/16" vertically.

Sash Expander is designed for use with CRL-Sash, and is not the Sill Expander product produced by Amesbury Industries.

HOW TO BUILD A CRL-SASH STORM PANEL

Panel Size: The exact size of the panel to be fabricated is determined by the size of the opening and method of installation (panel will either be recessed in the jamb or clipped on the surface of the jamb). Once the panel is calculated, it should be fabricated as follows:

If using Square Cut Corners

1. Cut length of CRL-Sash = Panel width or height less 1-7/16".
2. Glass Size = Cut length of CRL-Sash plus 5/8".

Note: If Sash Expander is to be used, the cut length for vertical members should be Desired Panel Height less 1-3/4".

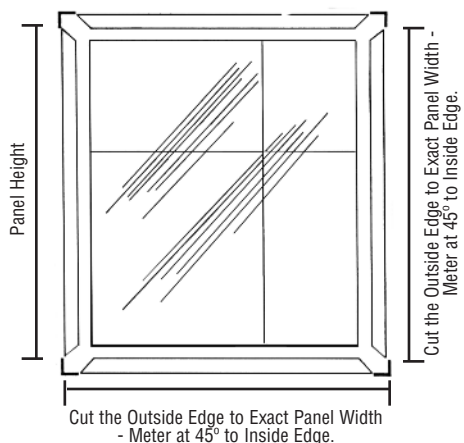
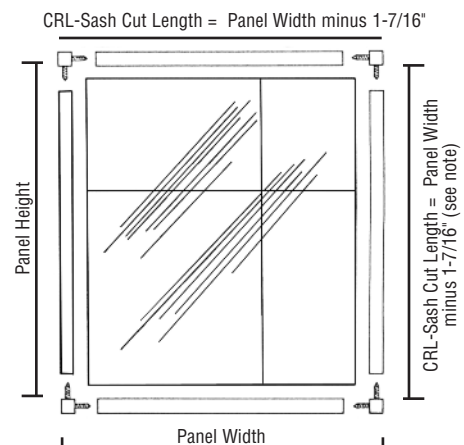

If Using Zinc Miter Cut Corners

1. Cut length of CRL-Sash = Desired panel width or height outside edge corners. Miter cut at exactly 45 degrees.
2. Glass Size = Overall panel size minus 5/8".

Note: If Sash Expander is to be used, the cut length for verticals should be overall panel height less 5/16".