

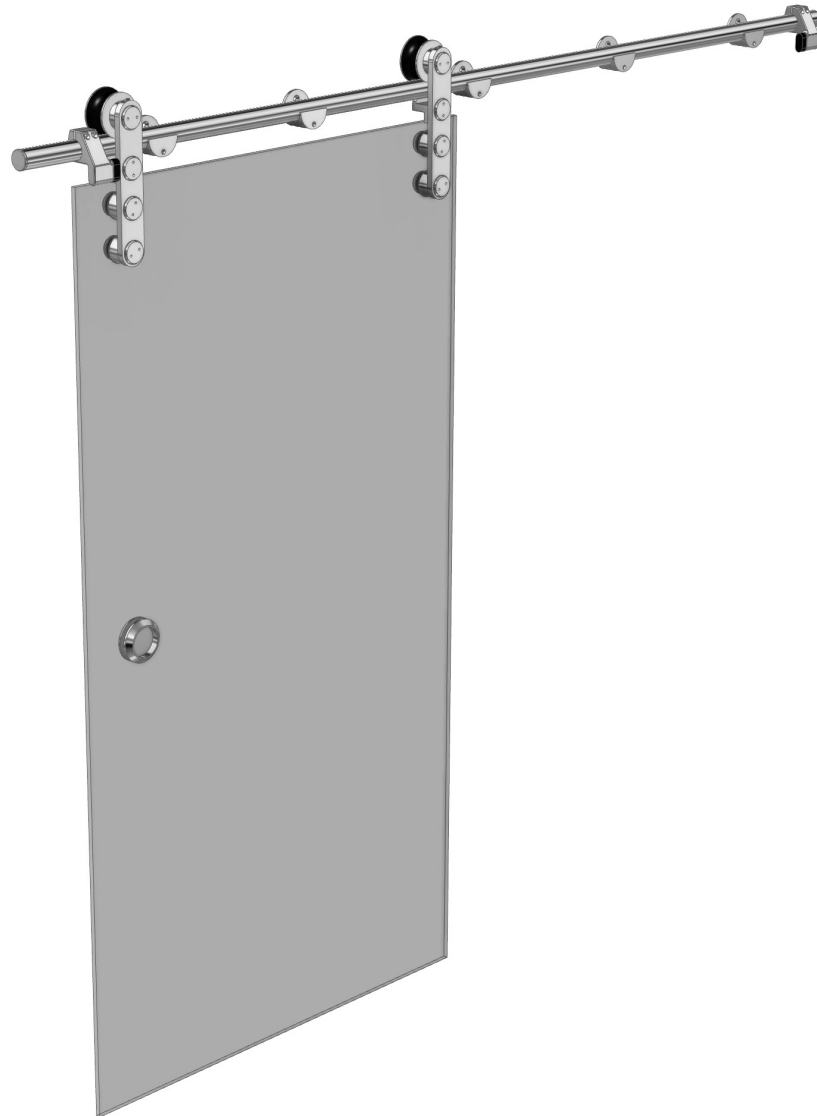

# LAGUNA SERIES





## SLIDING DOOR KITS

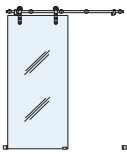
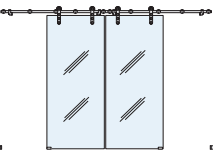
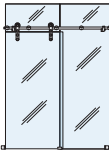
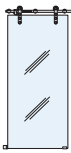
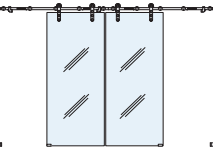
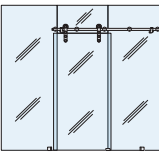
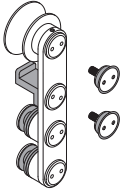
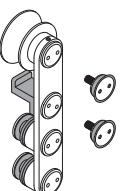
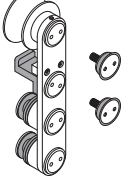
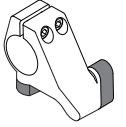
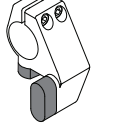
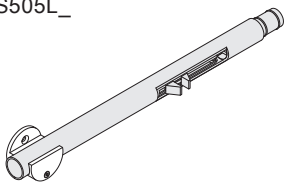
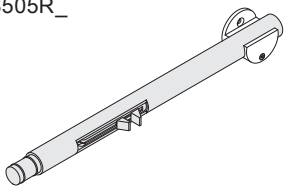
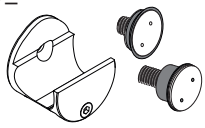
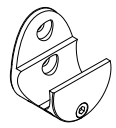
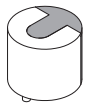
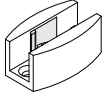

## ORDER OF ASSEMBLY AND INSTALLATION

PARTS LIST .....	3
INTRODUCTION .....	4
SYSTEM LIMITATIONS .....	4
GLASS FABRICATION .....	4 - 10
LSWM5_ Wall Mount Single Slider .....	5
LSWM6_ Wall Mount Bi-Parting Sliders.....	6
LSGM5_ Glass Mount Single Slider .....	7
LSGM6_ Glass Mount Single Slider with Sidelites.....	8
LSWM7_ Wall Mount Single Slider with Softbrake.....	9
LSWM8_ Wall Mount Bi-Parting Sliders with Softbrake.....	10
INSTALL HARDWARE: WALL MOUNT .....	11
Attach Wall Mount Clamps to Sliding Tube .....	11
Position Level to Wall .....	11
Mount the Wall Mount Clamps .....	12
Install Left and Right Door Stops .....	12
INSTALL HARDWARE: GLASS MOUNT .....	13
Attach Glass Mount Clamps .....	13
Assemble Glass Mount Clamps .....	13
Install Left and Right Door Stops .....	13
PREPARE AND HANG DOOR .....	14
Prepare Top Rollers .....	14
Mount Top Rollers Onto Door .....	14
Hang Door .....	15
Install Floor Guide .....	16
Install Anti-Lift Block .....	17
Install Floor Mount Door Stops .....	17
Place Glass Edge Protectors .....	18
Install Sliding Tube End Caps .....	18
INSTALL ACCESSORIES .....	19 - 21
Install Wall Mount End Cap (For LSGM5_ Only) .....	19
Install Thru-Glass Pull FP214_ (Optional) .....	19
Install Ceiling Mount Clamp LS412_ (Optional) .....	20
Install Softbrake (Optional for Wall Mount Applications) .....	21
MAINTENANCE .....	22
CARE AND CLEANING OF STAINLESS STEEL .....	22

# PARTS LIST

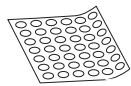
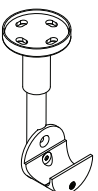
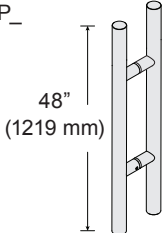
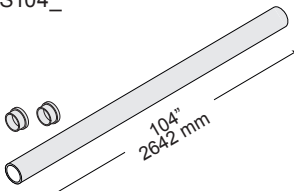
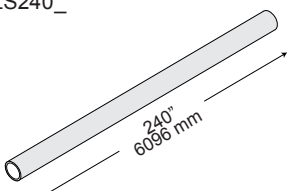
<p><b>LSWM5_</b></p>  <p><b>Kit Contains:</b>                  2 LS400_ 2 LS407_                  1 LS104_ 1 LS405L_                  5 LS402_ 1 LS405R_                  1 LS307_</p> <p>Wall Mount Single Slider Kit</p>	<p><b>LSWM6_</b></p>  <p><b>Kit Contains:</b>                  4 LS400_ 2 LS407_                  2 LS104_ 2 LS405L_                  10 LS402_ 2 LS405R_                  2 LS307_</p> <p>Wall Mount Bi-Parting Sliders Kit</p>	<p><b>LSGM5_</b></p>  <p><b>Kit Contains:</b>                  2 LS400_ 2 LS407_                  1 LS104_ 1 LS405L_                  6 LS403_ 1 LS405R_                  1 LS307_ 1 LS106_</p> <p>Glass Mount Single Slider Kit</p>	
<p><b>LSWM7_</b></p>  <p><b>Kit Contains:</b>                  2 LS400_ 1 LS405L_                  1 LS104_ 1 LS405R_                  3 LS402_ 1 LS505L_                  1 LS307_ 1 LS505R_                  2 LS407_</p> <p>Wall Mount Single Slider with Softbrake Kit</p>	<p><b>LSWM8_</b></p>  <p><b>Kit Contains:</b>                  4 LS400_ 2 LS405L_                  2 LS104_ 2 LS405R_                  6 LS402_ 2 LS505L_                  2 LS307_ 2 LS505R_                  2 LS407_</p> <p>Wall Mount Bi-Parting Sliders with Softbrake Kit</p>	<p><b>LSGM6_</b></p>  <p><b>Kit Contains:</b>                  2 LS400_ 2 LS407_                  1 LS104_ 1 LS405L_                  7 LS403_ 1 LS405R_                  1 LS307_</p> <p>Glass Mount Single Slider with Sidelites Kit</p>	
<p><b>LS300_</b></p>  <p>Anti-Lift Top Roller with Flush and Surface Mount Fittings</p>	<p><b>LS400_</b></p>  <p>Anti-Lift Top Roller with Flush and Surface Mount Fittings</p>	<p><b>LS500_</b></p>  <p>Anti-Lift Top Roller with Softbrake Bracket and Flush and Surface Mount Fittings</p>	
<p><b>LS405L_</b></p>  <p>Left Hand Door Stop</p>	<p><b>LS405R_</b></p>  <p>Right Hand Door Stop</p>	<p><b>LS505L_</b></p>  <p>Left Hand Softbrake Kit</p>	<p><b>LS505R_</b></p>  <p>Right Hand Softbrake Kit</p>
<p><b>LS403_</b></p>  <p>Glass Mount Clamp with Flush and Surface Mount Fittings</p>	<p><b>LS402_</b></p>  <p>Wall Mount Clamp</p>	<p><b>LS407_</b></p>  <p>Wall / Floor Mount Door Stop</p>	<p><b>LS307_</b></p>  <p>Adjustable Bottom Floor Guide</p>
<p><b>LS106_</b></p>  <p>Wall Mount End Cap for Top Sliding Tube</p>	<p><b>LS104CAP_</b></p>  <p>Replacement End Cap for Top Sliding Tube</p>	<p><b>FP214_</b></p>  <p>Thru-Glass Pull</p>	<p><b>CB1PK</b></p>  <p>CRL Silicone Bumpons 5 x 11.1 mm</p>
<p><b>LS412_</b></p>  <p>Ceiling Mount Clamp for Top Sliding Tube</p>	<p><b>48LP_</b></p>  <p>48" (1219 mm) Straight Ladder Pull</p>	<p><b>LS104_</b></p>  <p>104" 2642 mm                  Top Sliding Tube with Two End Cap</p>	<p><b>LS240_</b></p>  <p>240" 6096 mm                  240" (6096 mm) Top Sliding Tube</p>

## INTRODUCTION

Thank you for purchasing the CRL Laguna Series Sliding Glass Door System. We have upgraded our popular Laguna Series Sliding Glass Door System to now include an 'anti-lift' feature. Through a combination of additions and very subtle changes, we have improved the performance, safety, and security while maintaining a clean, simple look. The Laguna Series Sliding Glass Door System can be attached to glass or directly to the side of a sufficiently reinforced wall. The adjustable Top Rollers make final adjustments quick and easy, without the need to remove the door. Their smooth operation and solid stainless steel construction minimizes maintenance issues. CRL provides you with all the glass attachment fasteners for either flush mounting, requiring a countersunk hole, or surface mounting, requiring a straight hole. The glass attachment fasteners accommodate either 3/8" or 1/2" (10 or 12 mm) tempered glass.

Standardized sets allow you to make planning and purchasing quick and easy for basic installations. We offer six different kits; two for wall mounting, two for wall mounting with softbrake, and two for glass mounting. Available accessories give you the opportunity to customize the standard sets to accommodate the most imaginative designers.

**IMPORTANT: READ THIS MANUAL THOROUGHLY BEFORE BEGINNING INSTALLATION.**

## SYSTEM LIMITATIONS

Minimum Door Width: 37-13/16" (960 mm)

Maximum Door Width: 53-9/16" (1.36 m)

Maximum Door Height: 98-7/16" (2.5 m)

Maximum Weight: 220 lbs (100 kg)

NOTE: Laminated glass cannot be used in these systems.

## GLASS FABRICATION

Hole fabrication is required prior to tempering. The placement and type of hole is determined by each configuration. First determine if the system is a glass mount or wall mount and whether it has one or more sliding doors.

The glass fabrication for each of the following basic layouts are detailed in this section:

Wall Mount: Single Slider, Bi-Parting Sliders

Wall Mount with Softbrake: Single Slider, Bi-Parting Sliders

Glass Mount: Single Slider, Single Slider with Sidelite

All kits include both flush and surface mount fasteners. Identify your specific kit model and refer to the following pages for specific hole locations.

PLEASE NOTE: SYSTEMS WITH SOFTBRAKES REQUIRE DIFFERENT GLASS FABRICATION.

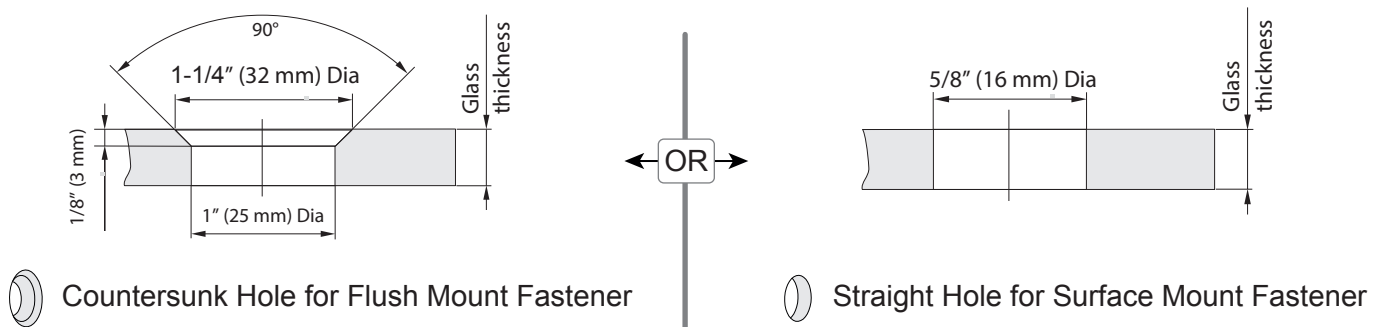

# GLASS FABRICATION (CONTINUED)

## LSWM5\_ Wall Mount Single Slider

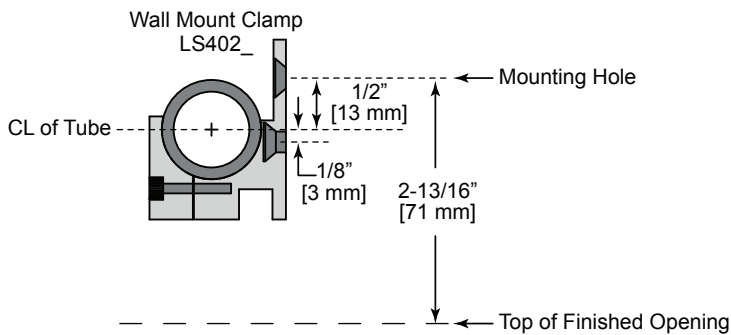
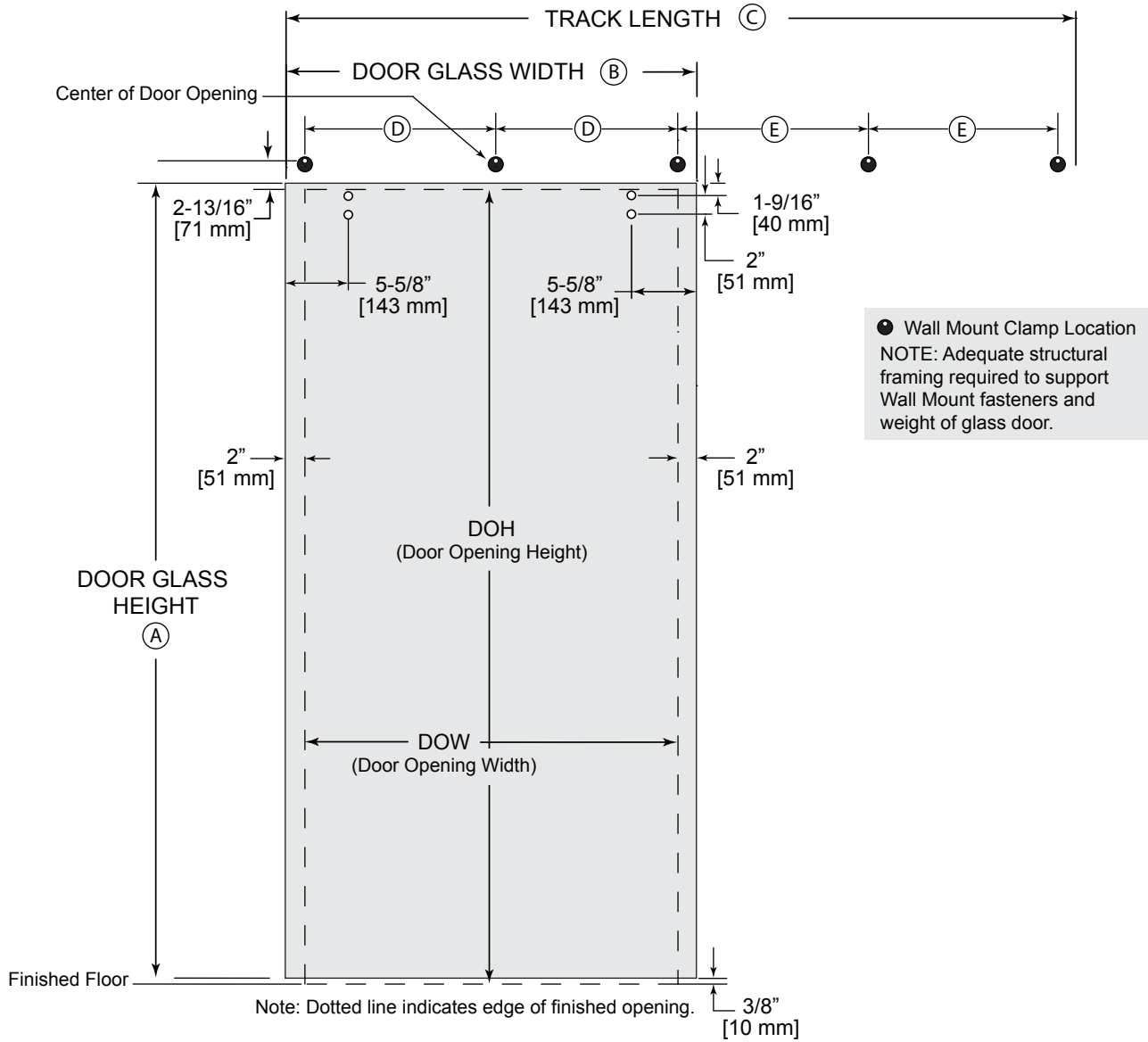

- DOOR GLASS HEIGHT (A) = DOH + 1/2" [13 mm]
- DOOR GLASS WIDTH (B) = DOW + 4" [102 mm]
- TRACK LENGTH (C) = (DOW x 2) + 6" [152 mm]
- (D) = DOW ÷ 2
- (E) = ((B) ÷ 2) - 1" [25 mm]

# GLASS FABRICATION (CONTINUED)

## LSWM6\_ Wall Mount Bi-Parting Sliders

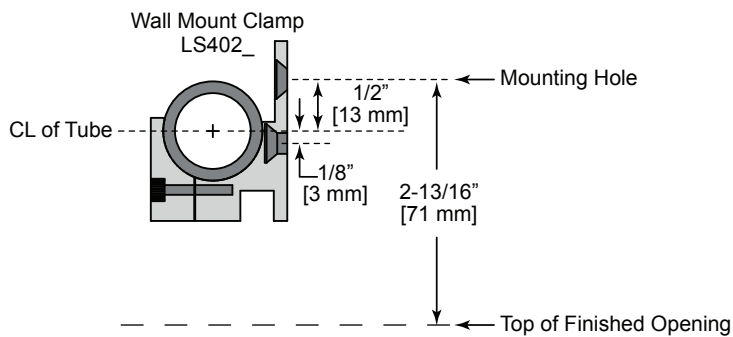
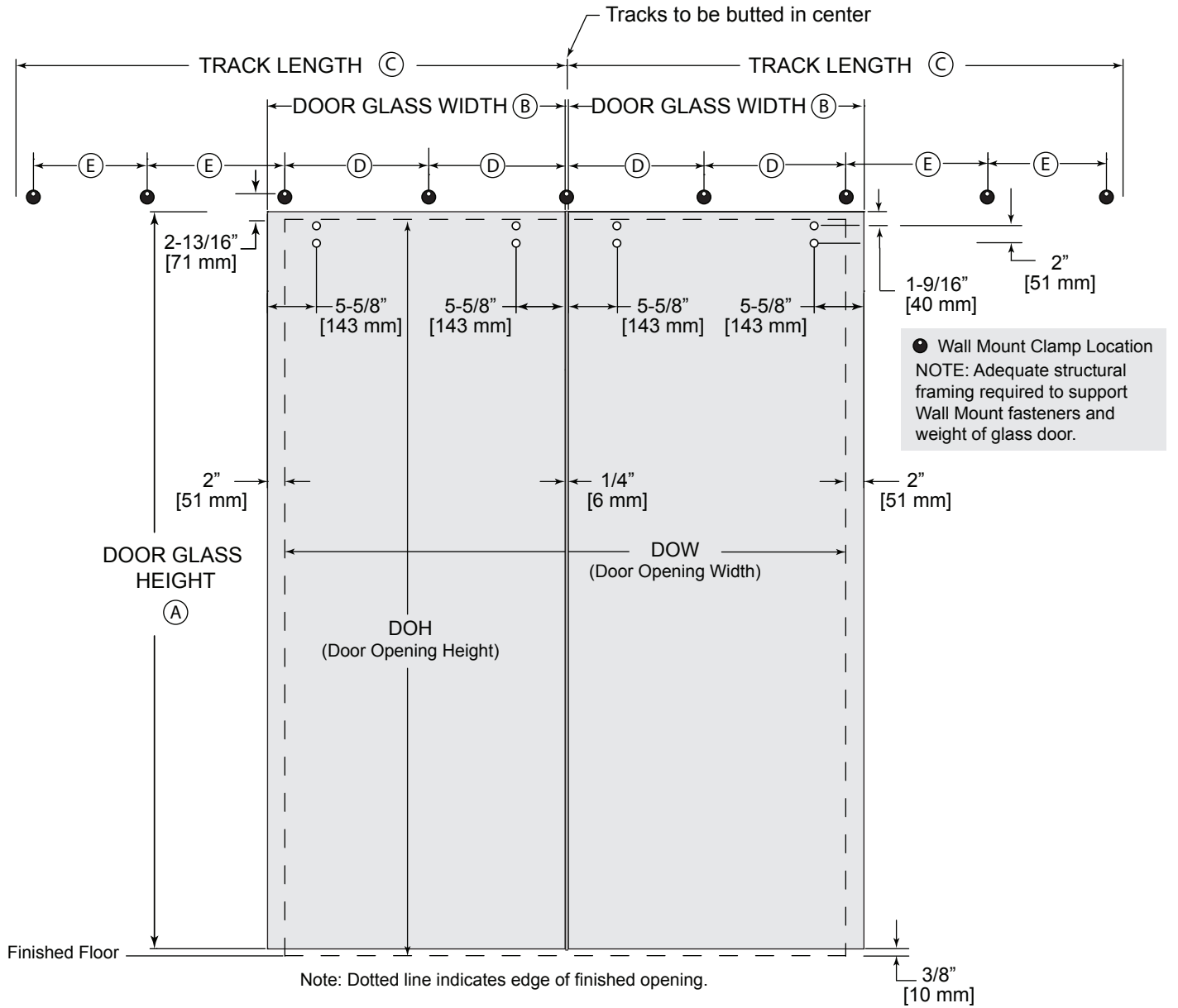

DOOR GLASS HEIGHT (A) = DOH + 1/2" [13 mm]

DOOR GLASS WIDTH (B) = (DOW ÷ 2) + 1-7/8" [48 mm]

TRACK LENGTH (C) = (DOW x 2) + 2" [51 mm]

(D) = DOW ÷ 4

(E) = DOW ÷ 4

# GLASS FABRICATION (CONTINUED)

## LSGM5\_ Glass Mount Single Slider

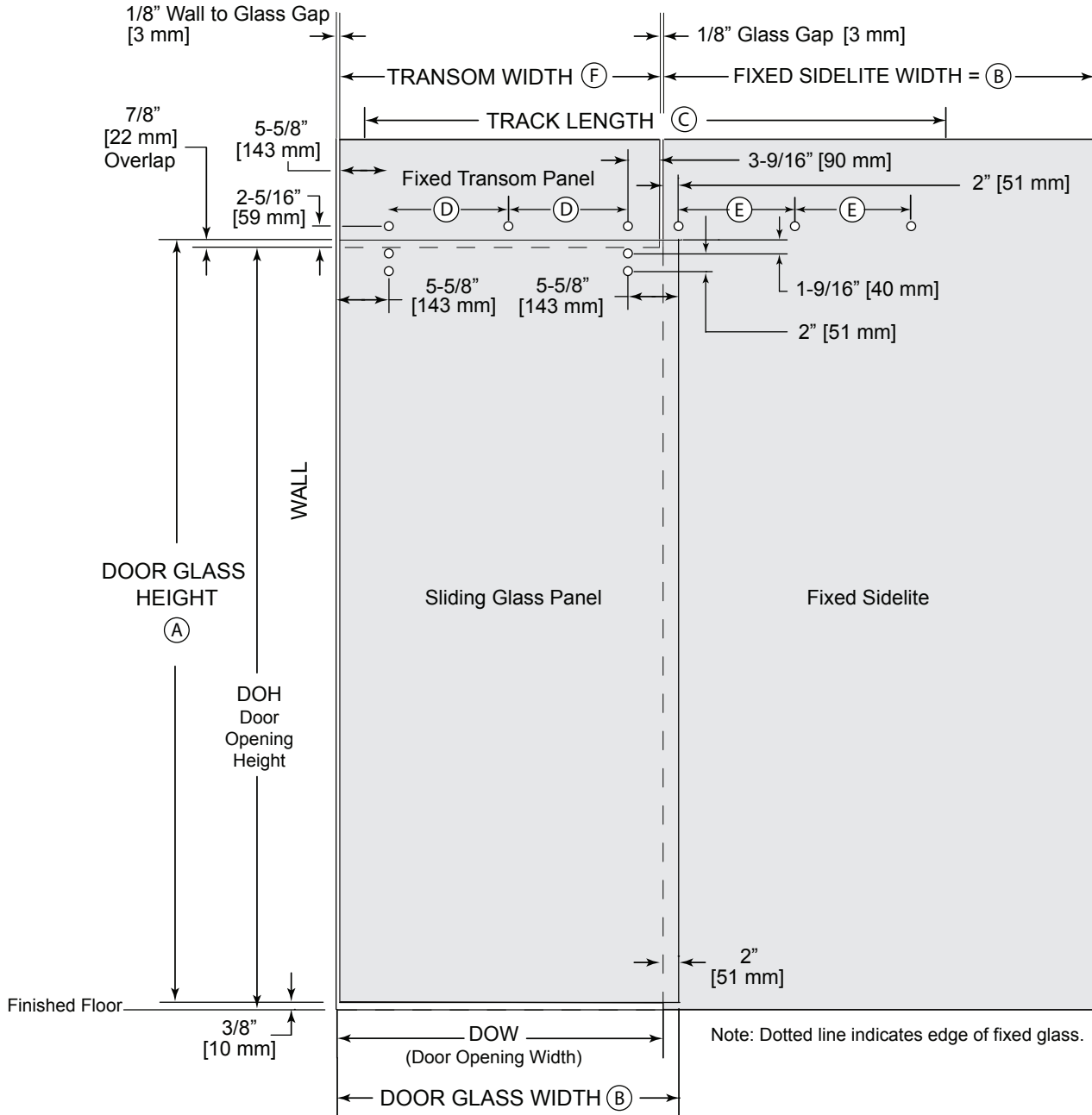

DOOR GLASS HEIGHT (A)

DOH Door Opening Height

Finished Floor

3/8" [10 mm]

DOW (Door Opening Width)

Note: Dotted line indicates edge of fixed glass.

DOOR GLASS WIDTH (B)

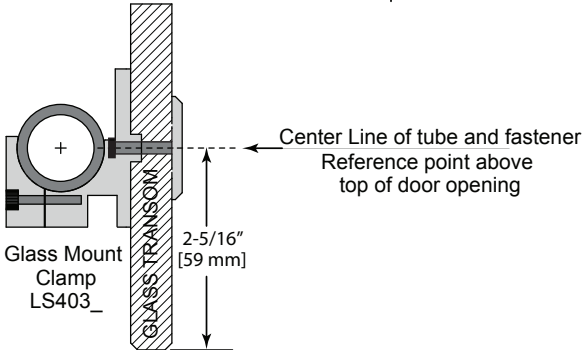

- DOOR GLASS HEIGHT (A) = DOH + 1/2" [13 mm]
- DOOR GLASS WIDTH (B) = DOW + 2" [51 mm]
- TRACK LENGTH (C) = (B x 2) - 3" [76 mm]
- (D) = (F ÷ 2) - 4-9/16" [116 mm]
- (E) = DOW ÷ 2 - 1" [25 mm]
- TRANSOM WIDTH (F) = DOW - 1/4" [6 mm]

# GLASS FABRICATION (CONTINUED)

## LSGM6\_ Glass Mount Single Slider with Sidelites

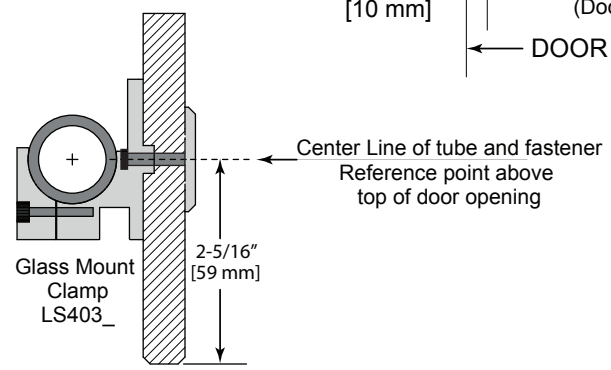
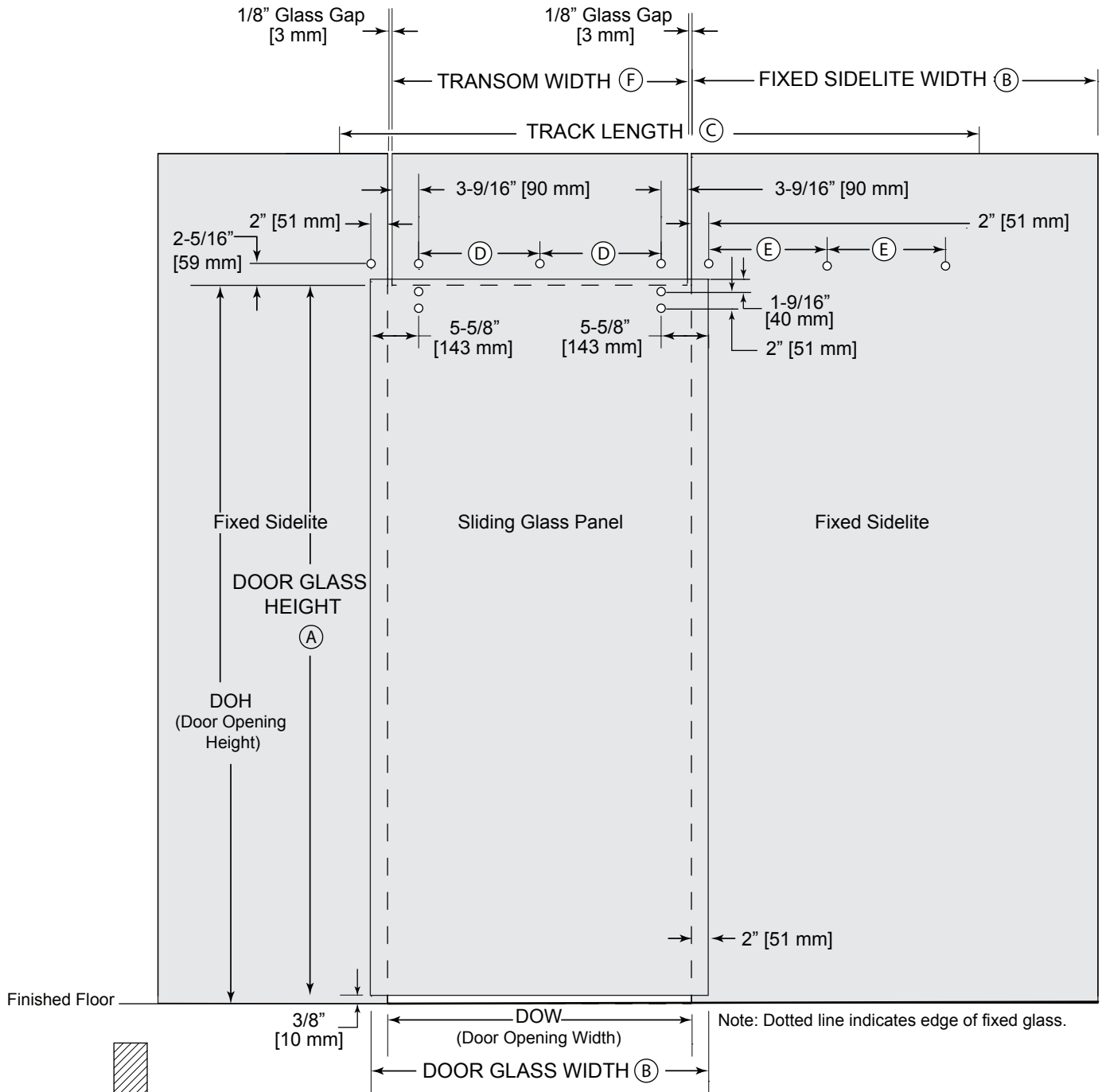

- DOOR GLASS HEIGHT (A) = DOH + 1/2" [13 mm]
- DOOR GLASS WIDTH (B) = DOW + 4" [102 mm]
- TRACK LENGTH (C) = (B) x 2
- (D) = ((F) ÷ 2) - 3-9/16" [90 mm]
- (E) = DOW ÷ 2
- TRANSOM WIDTH (F) = DOW - 1/4" [6 mm]



# GLASS FABRICATION (CONTINUED)

## LSWM7\_ Wall Mount Single Slider with Softbrake

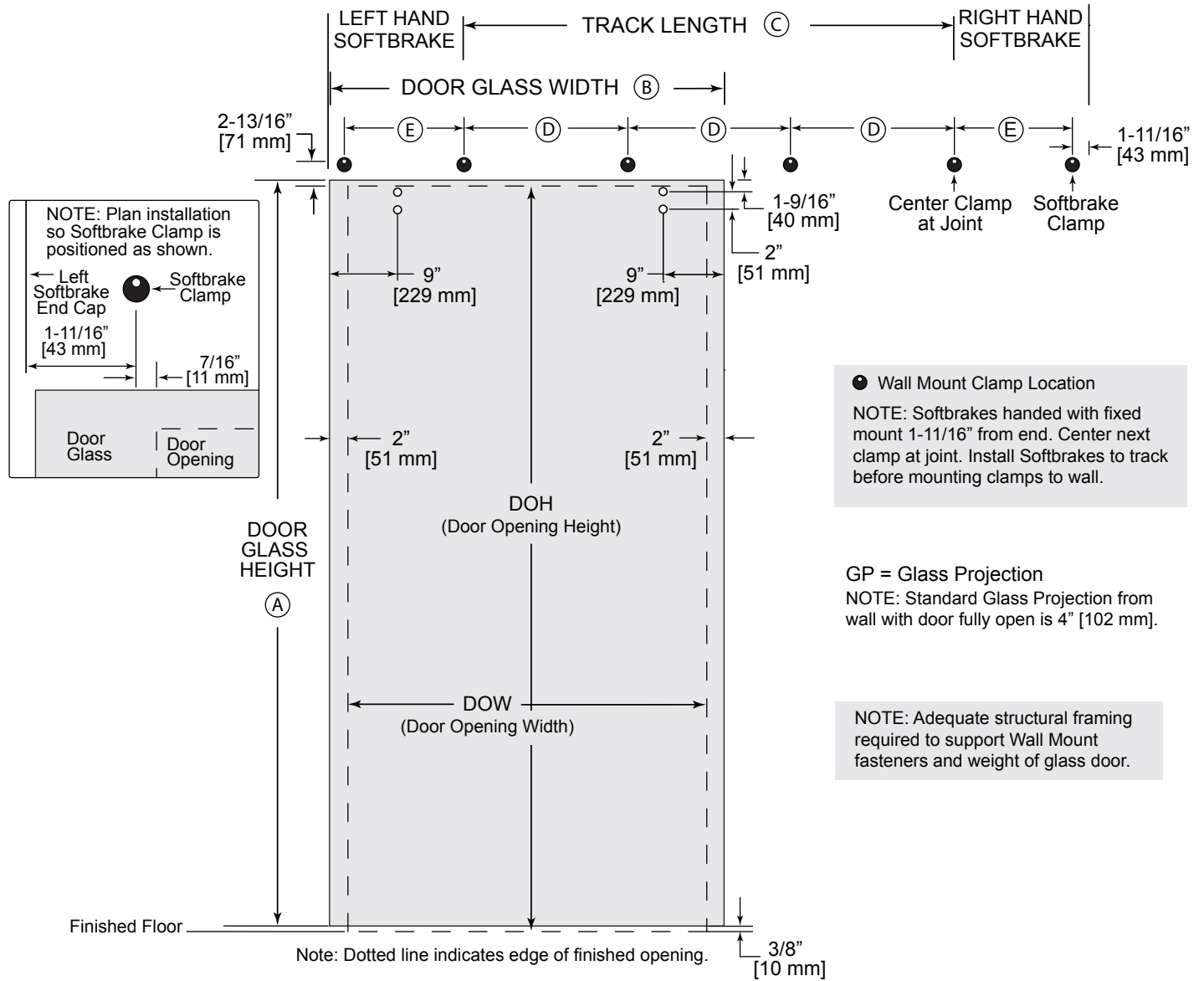

DOOR GLASS HEIGHT (A) = DOH + 1/2" [13 mm]

DOOR GLASS WIDTH (B) = DOW + 4" [102 mm]

TRACK LENGTH (C) = (DOW x 2) - 21-3/4" [553 mm] - GP

SOFTBRAKE LENGTH = 14" [356 mm] with End Cap

(D) = (C) ÷ 3

(E) = 12-5/16" [313 mm]

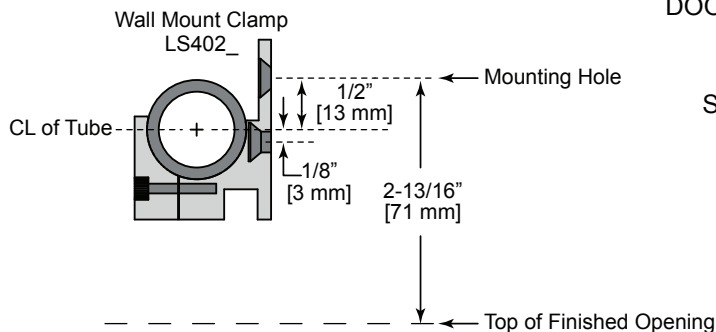

# GLASS FABRICATION (CONTINUED)

## LSWM8\_ Wall Mount Bi-Parting Sliders with Softbrake

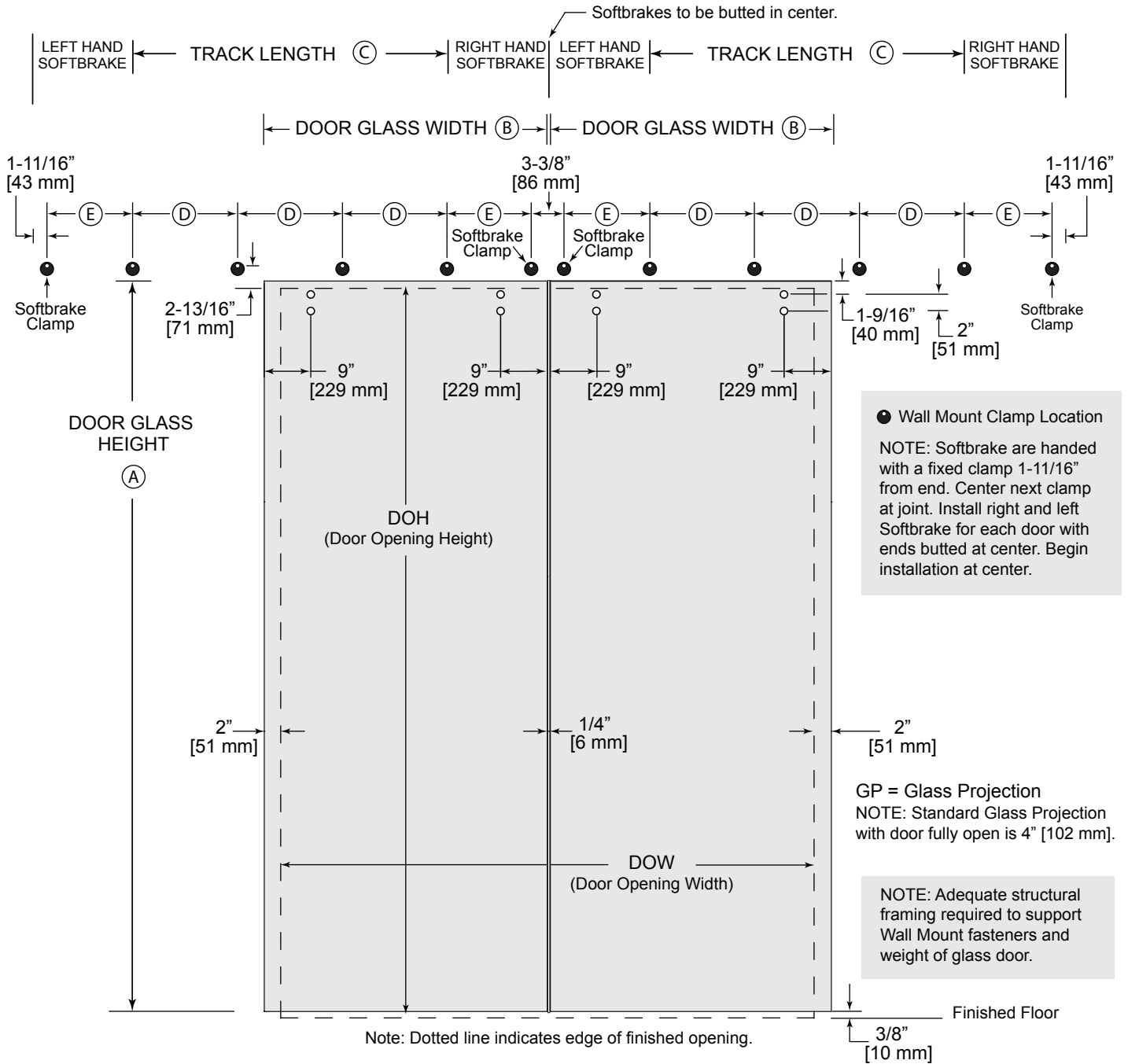

● Wall Mount Clamp Location

NOTE: Softbrake are handed with a fixed clamp 1-11/16" from end. Center next clamp at joint. Install right and left Softbrake for each door with ends butted at center. Begin installation at center.

GP = Glass Projection

NOTE: Standard Glass Projection with door fully open is 4" [102 mm].

NOTE: Adequate structural framing required to support Wall Mount fasteners and weight of glass door.

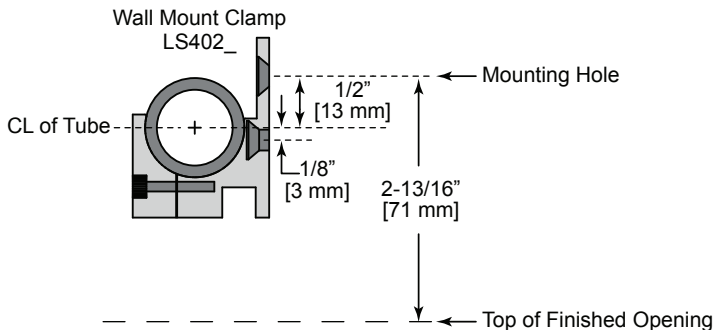

DOOR GLASS HEIGHT (A) = DOH + 1/2" [13 mm]

DOOR GLASS WIDTH (B) = (DOW ÷ 2) + 1-7/8" [48 mm]

TRACK LENGTH (C) = DOW - 26" [660 mm] - GP

SOFTBRAKE LENGTH = 14" [356 mm]

(D) = (C) ÷ 3

(E) = 12- 5/16" [313 mm]

## INSTALL HARDWARE: WALL MOUNT

### 1. Attach Wall Mount Clamps to Sliding Tube

Cut Sliding Tube to length. Prepare on a flat surface to keep Wall Mount Clamps aligned. Place Clamps in correct position. Refer to hole location details for correct Clamp spacing. Hand tighten to hold Sliding Tube.

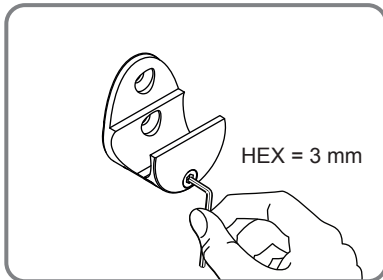
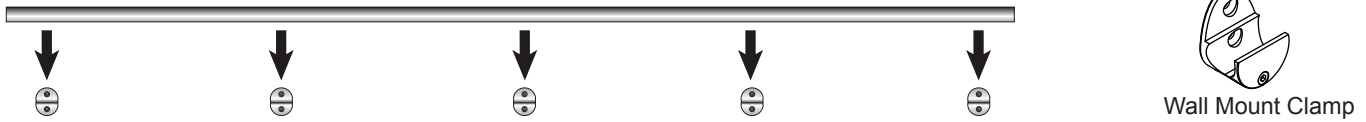

Loosen to separate.

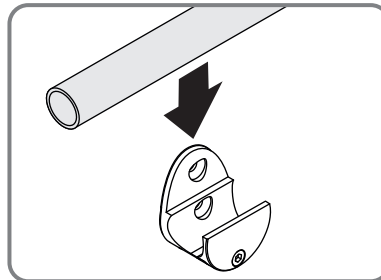

Fit Sliding Tube into Wall Clamps.

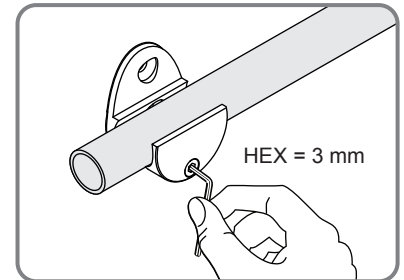

Hand tighten.

### 2. Position Level to Wall

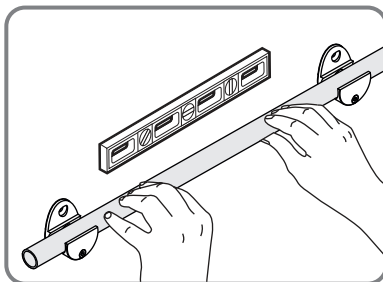

Ensure Sliding Tube is level.

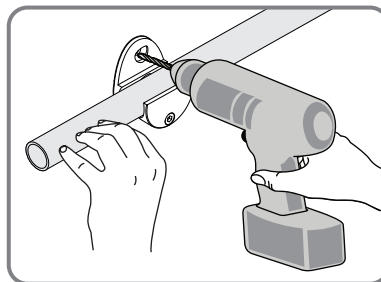

Drill pilot hole for fasteners to be used. (not included)

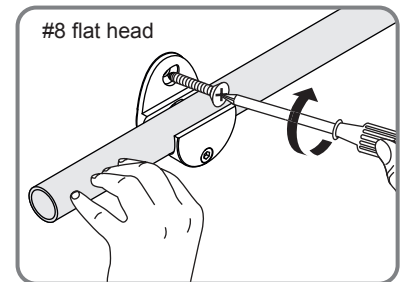

Secure with screw properly anchored to the substrate. (not included)

## INSTALL HARDWARE: WALL MOUNT (CONTINUED)

### 3. Mount the Wall Mount Clamps

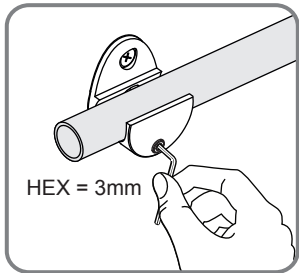

Loosen Wall Clamp and remove Sliding Tube.

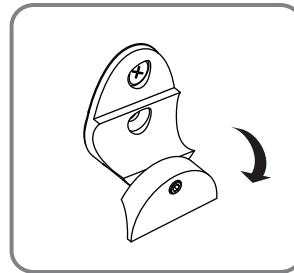
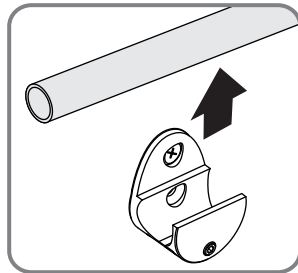

Move bottom part of Clamp down to drill pilot hole.

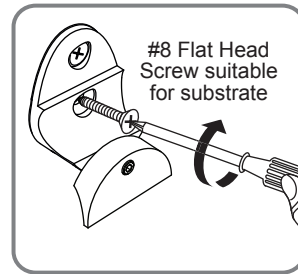
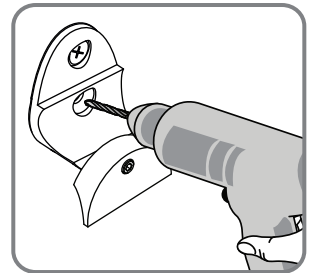

Secure to with fastener (not included).

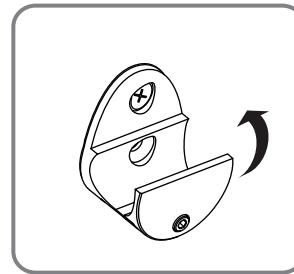

Return bottom part of Clamp to upright position.

### 4. Install Left and Right Door Stops

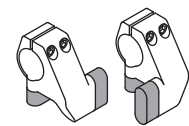
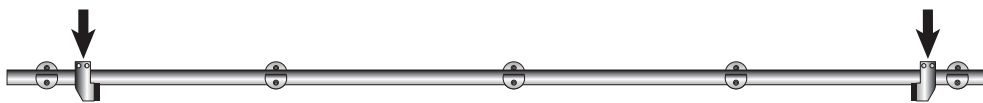

Left and Right Door Stops

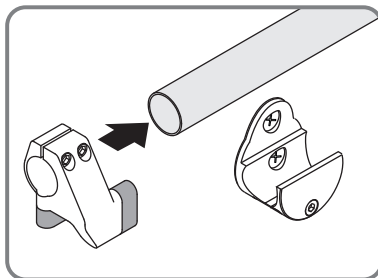

Slide left and right Door Stops onto Sliding Tube.

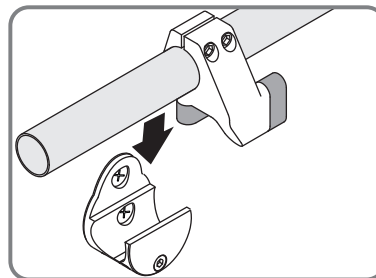

Ensure each Stop clears outboard Clamp when placing Tube.

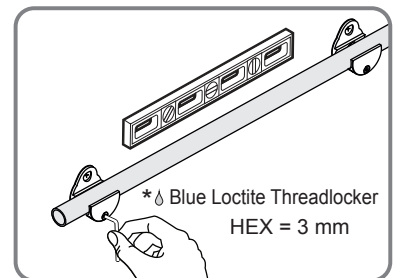

When Tube is level, tighten the Wall Clamps.

\* Blue Loctite Threadlocker is recommended on all screw threads during final assembly.

# INSTALL HARDWARE: GLASS MOUNT

## 1. Attach Glass Mount Clamps

Use either Surface or Flush Mount.

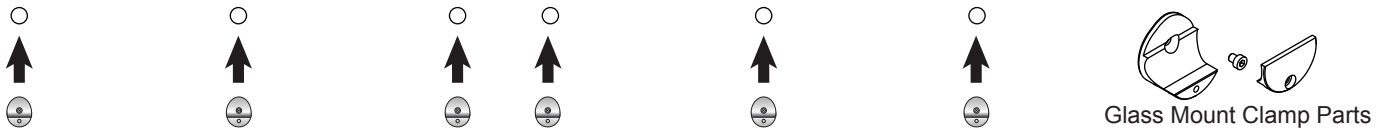

Tighten to 11 ft-lbs, 15 Nm

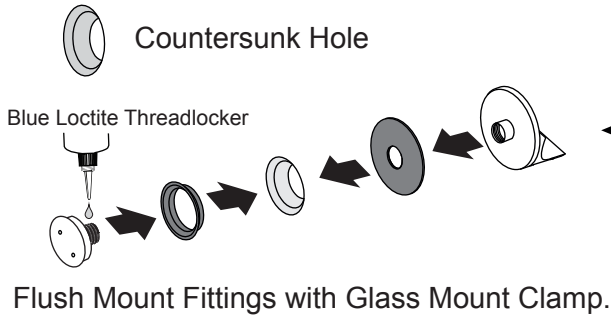

OR

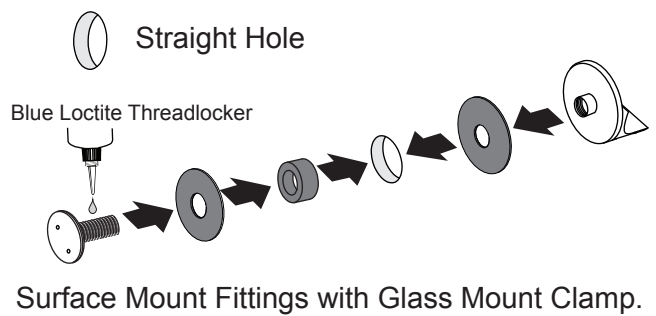

## 2. Assemble Glass Mount Clamps

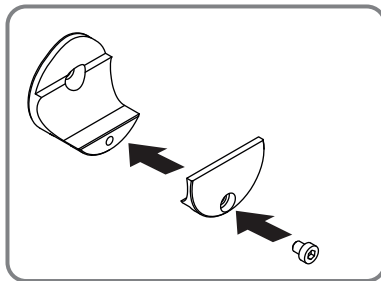

Loosely assemble

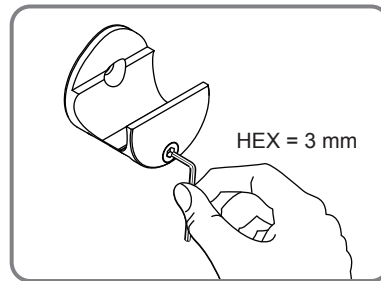

Hand tighten

## 3. Install Left and Right Door Stops

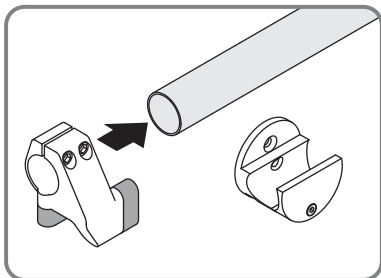
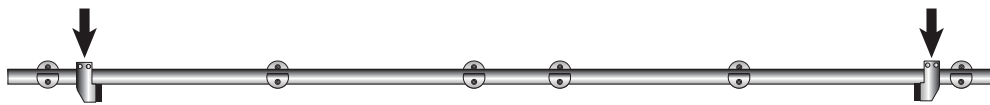

Slide left and right Door Stops onto Sliding Tube.

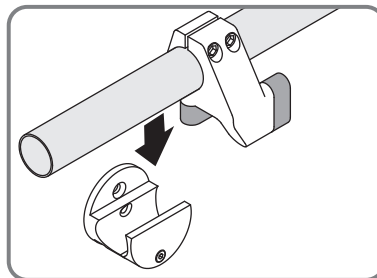

Ensure each Stop clears outboard Clamp when placing Tube.

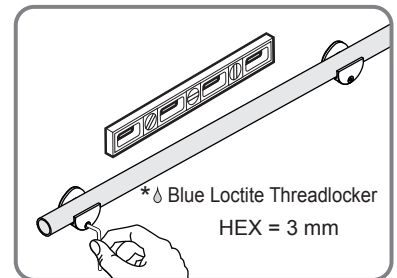

Level Tube and tighten Glass Clamps.

\* Blue Loctite Threadlocker is recommended on all screw threads during final assembly.

# PREPARE DOOR

## 1. Prepare Top Rollers

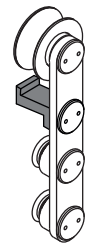

Top Roller

Use spanner head tool to remove Anti-Lift and Door Mount Fittings and loosen Top Roller.

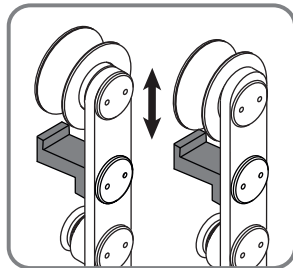
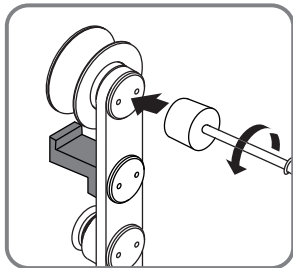

Loosen Top Roller so it easily moves up and down.

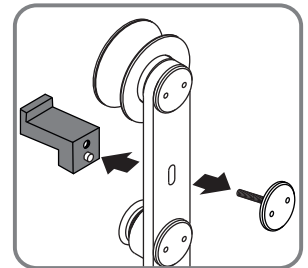
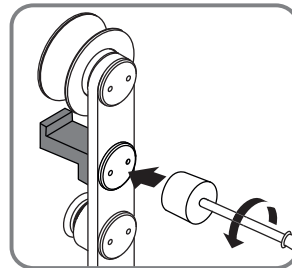

Remove Anti-lift Block and store in a safe place.

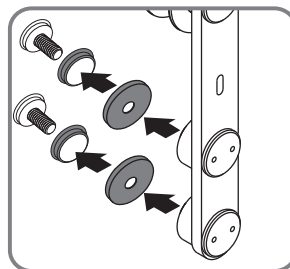
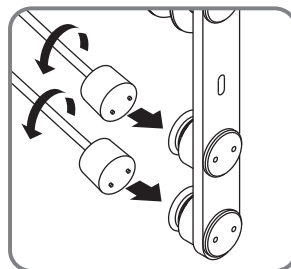

Remove Mounting Fittings and store in a safe place.

## 2. Mount Top Rollers Onto Door

⤵ Tighten to 11 ft-lbs, 15 Nm

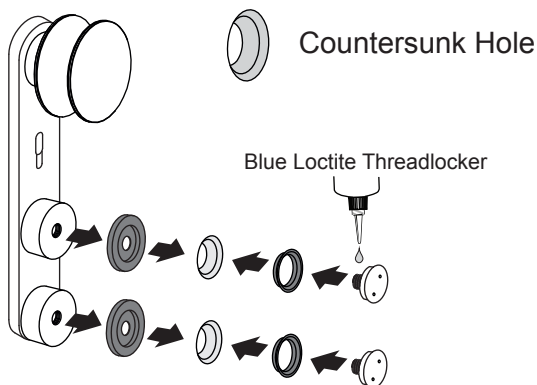

Flush Mount Fittings with Top Roller

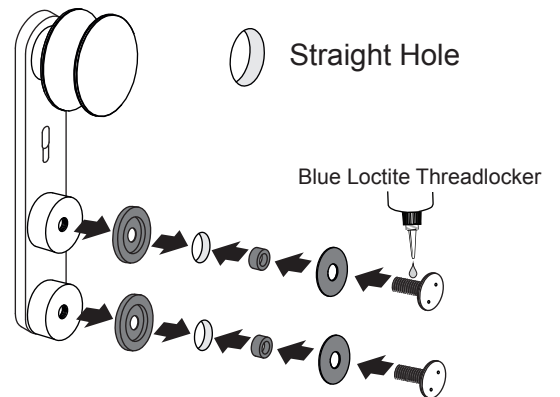
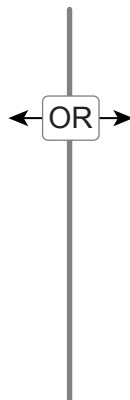

Surface Mount Fittings with Top Roller

NOTE: Mounting posts have minimal adjustment to help with incorrectly located holes in glass.

# INSTALL DOOR

## 1. Hang Door

Place Top Rollers onto Sliding Tube. Support weight of door at level and tighten Set Screw at top of Roller.

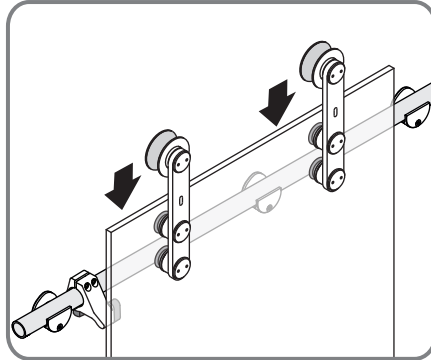
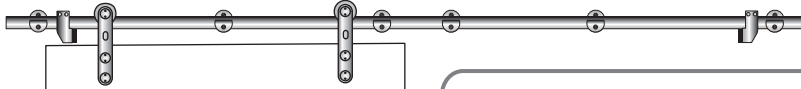

Place Top Rollers onto Tube.

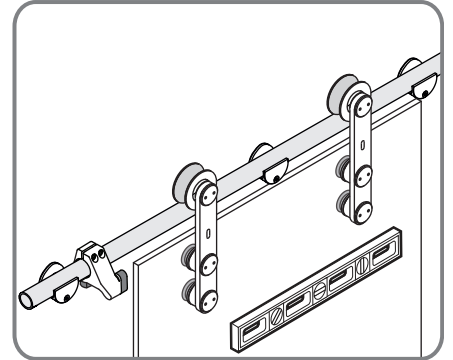

Level and plumb door.

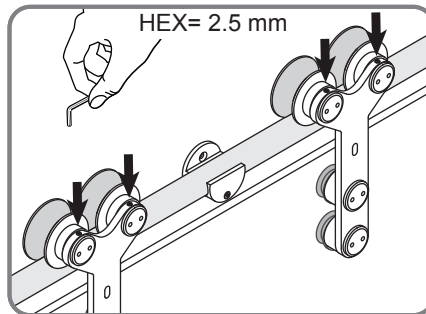

Support door weight and use Set Screw in Top Rollers to adjust height.

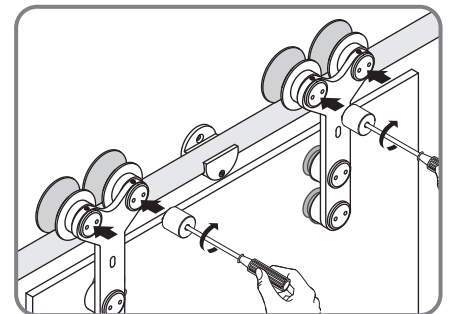

Tighten Top Rollers with Spanner Head Tool.

# INSTALL DOOR (CONTINUED)

## 2. Install Floor Guide

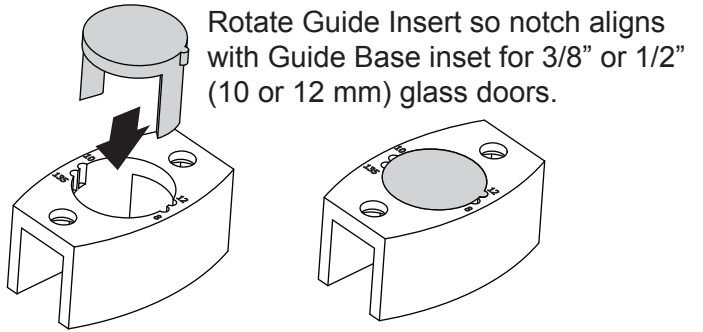
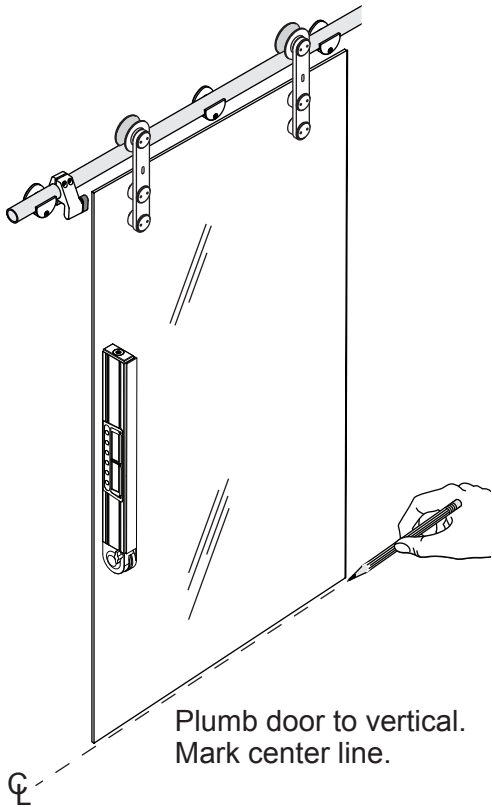

Position Floor Guide to align with wall.  
NOTE: Door overlaps wall 2" (51 mm).

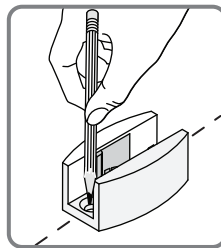
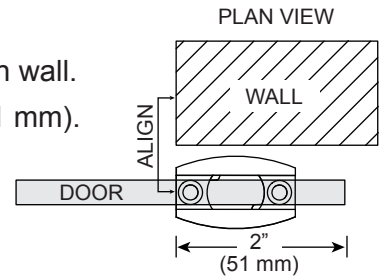

Remove door. Mark and drill holes.

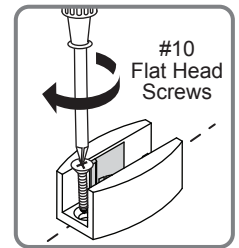
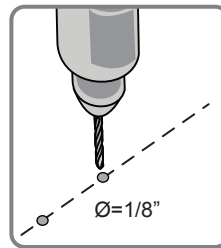

Install with fasteners suitable for substrate.

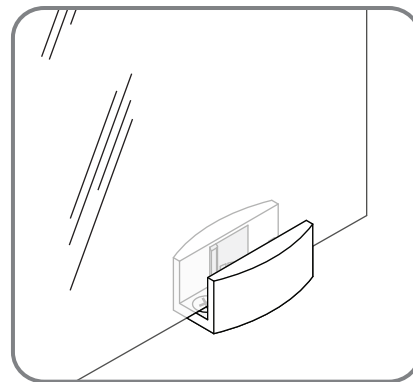
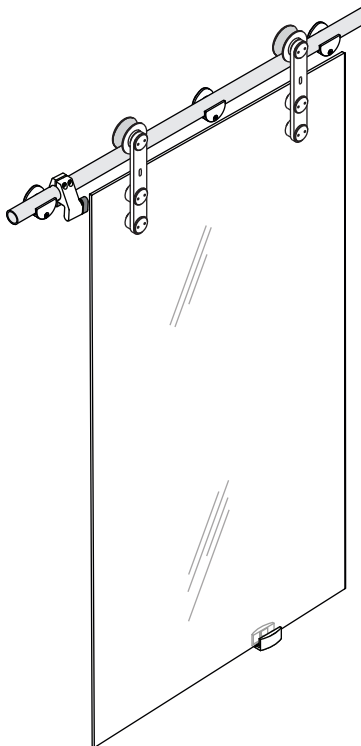

Hang door again making sure it is engaged with the floor guide.



## INSTALL DOOR (CONTINUED)

### 3. Install Anti-Lift Block

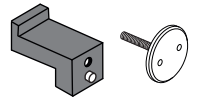
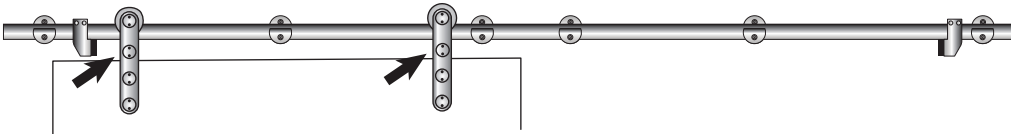

Anti-Lift Block

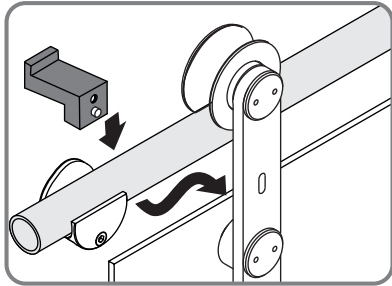

Fit Anti-Lift Block under Sliding Tube.

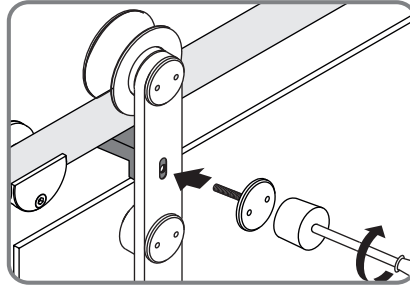

Tighten with Spanner Head Tool.

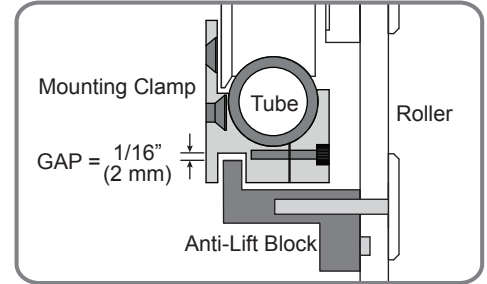

Adjust Anti-Lift Block so Roller moves freely through Mounting Clamps.

### 4. Install Floor Mount Door Stops

Open door and position Door Stop.

Slide Door Stop so it contacts Top Roller. Tighten top Door Stop Set Screws to secure.

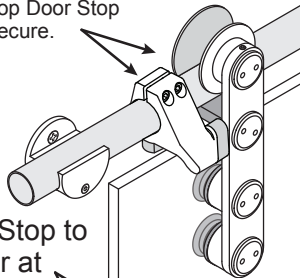

Align Floor Stop to contact door at same position.

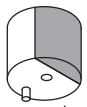

Floor Stop anchored at one end. Drill holes for screw and anchor to install.

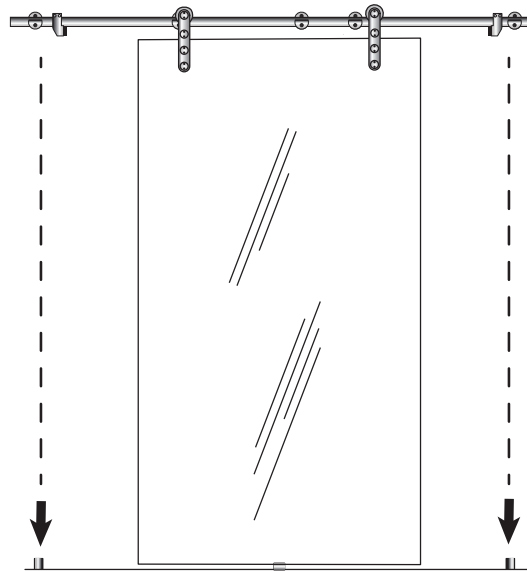

Install Floor Stops below Left and Right Door Stops. Rubber side faces door.

Close door and position and tighten Door Stop.

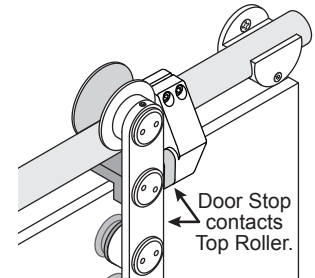

Align Floor Stop to contact door at same position.

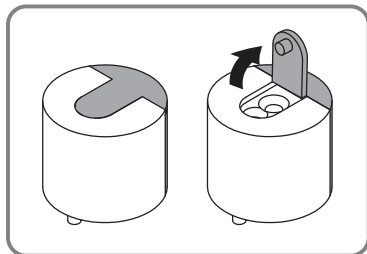
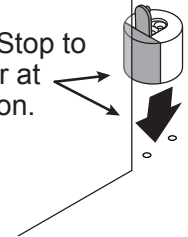

Lift Rubber Cover to mark holes and install.

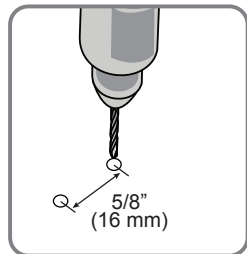

Drill holes.

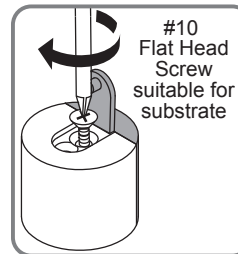

Install.

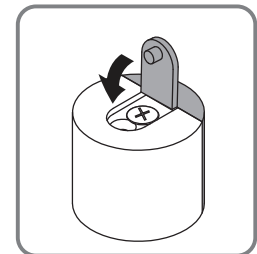

Close Rubber Cover.

NOTE: The Floor Mount Door Stops may also be mounted to the wall.

## INSTALL DOOR (CONTINUED)

### 5. Place Glass Edge Protectors

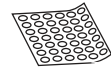
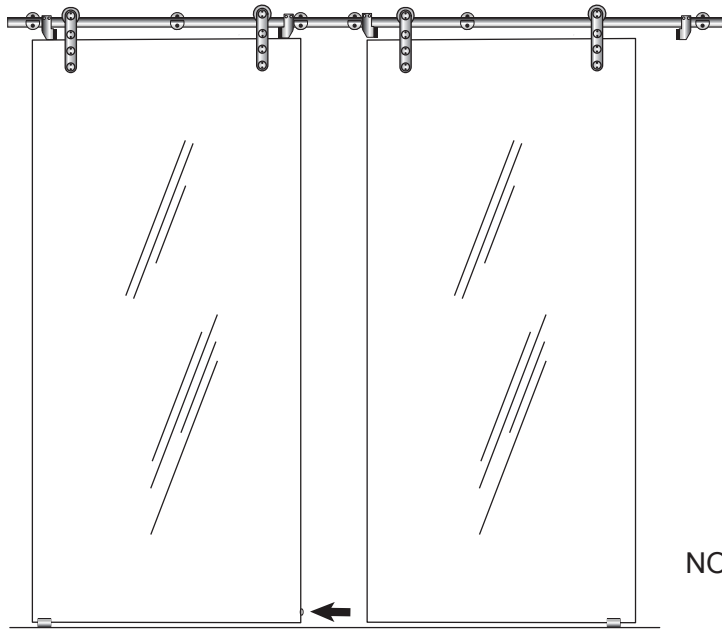

CB1PK Clear Silicone Bumpons

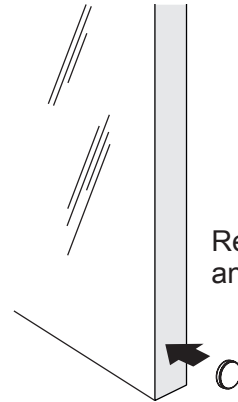

Remove from backing and place on door edge.

NOTE: For use with double doors.

Position one inch from bottom of door.

### 6. Install Sliding Tube End Caps

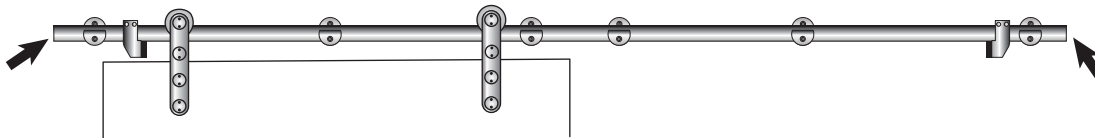

Sliding Tube End Cap

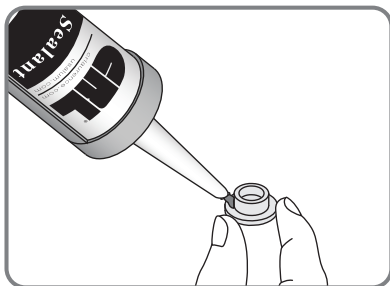

Use a dab of RTV408C silicone to hold cap in place.

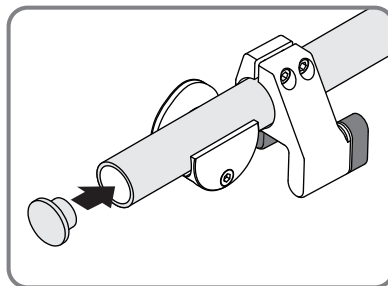

Insert into each end of Sliding Tube.

## INSTALL ACCESSORIES

### Install Wall Mount End Cap (For LSGM5\_ Only)

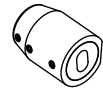

Wall Mount End Cap

Use when top Sliding Tube terminates into a wall. Use instead of last Mounting Clamp. Mount to wall.

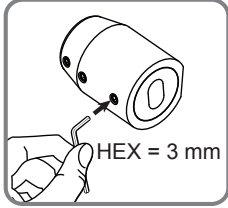

Loosen Set Screw to remove Wall Mount.

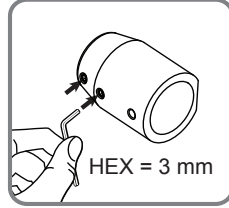
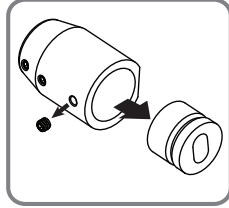

Loosen Set Screws.

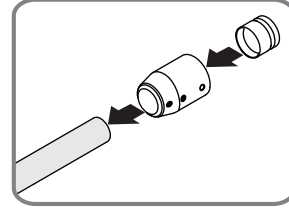

Slide onto Tube.

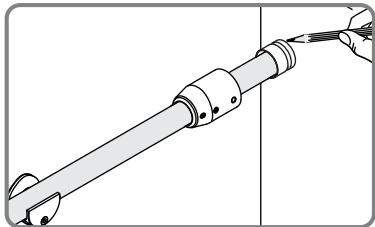

Rest Tube on Glass Clamps to mark position.

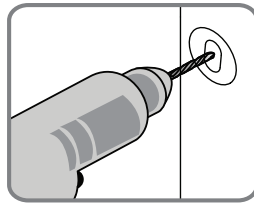

Install Wall Mount. Rest Tube on Glass Clamps and fit into Mount.

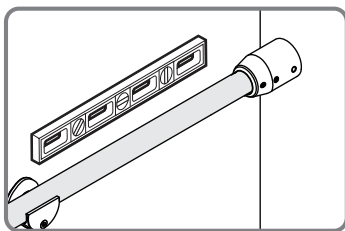
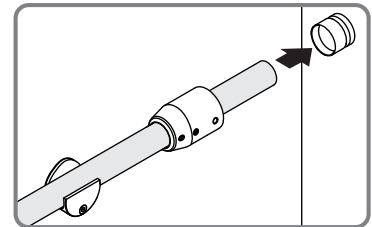
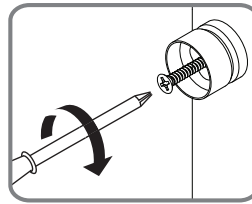

Ensure Sliding Tube is level. Tighten Set Screws in Wall Mount and Glass Clamps.

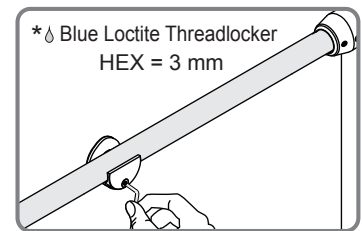
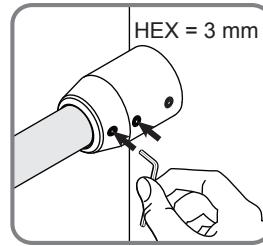
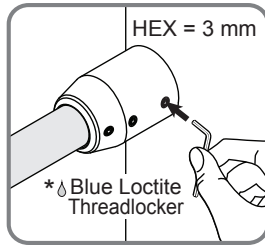

\* Blue Loctite Threadlocker is recommended on all screw threads during final assembly.

### Install Thru-Glass Pull FP214\_ (Optional)

For 3/8" (10 mm) to 1/2" (12 mm) Tempered Glass

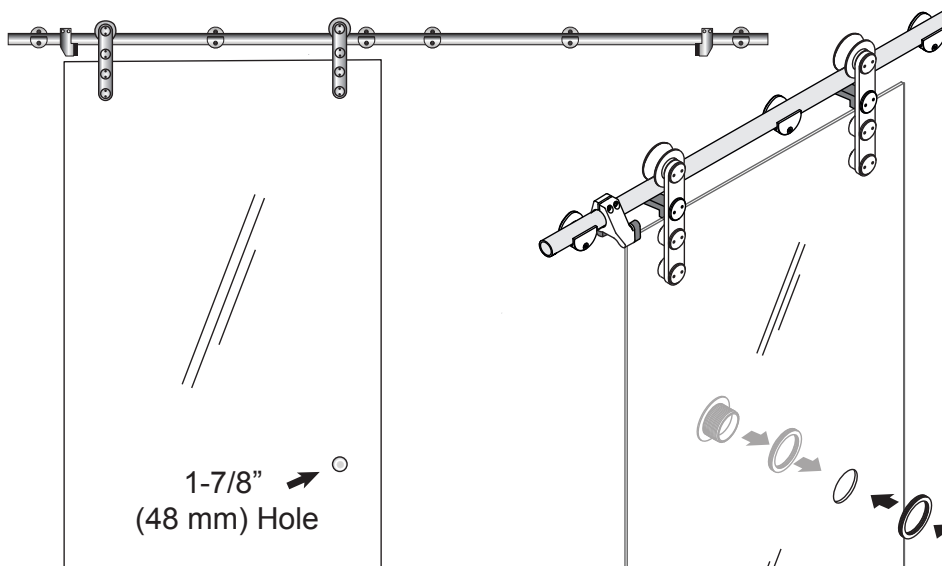

Thru-Glass Pull  
FP214\_

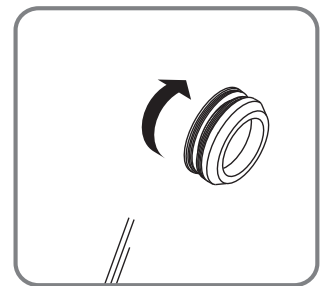

Thread together.

## INSTALL ACCESSORIES (CONTINUED)

### Install Ceiling Mount Clamp LS412\_ (Optional)

Use to replace wall mount clamps. Attaches to structural ceiling sufficient to support the load of the sliding glass doors up to 220 lbs (100 kg). Position the centerline of the Sliding Tube 4-7/16" (113 mm) down from ceiling with 3/16" (5 mm) up or down adjustment.

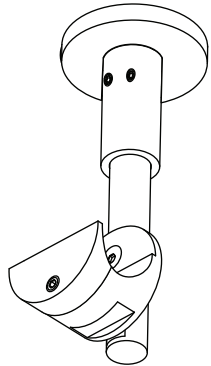
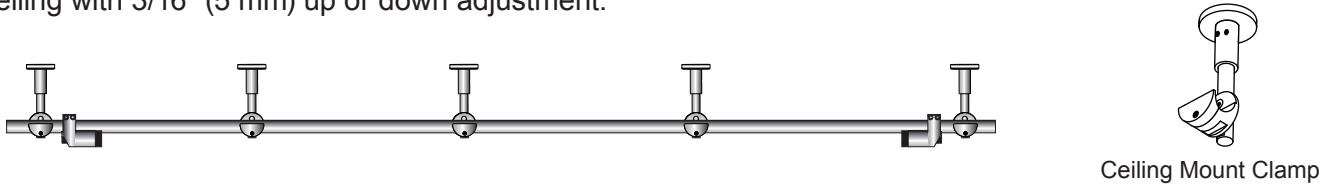

Loosen set screws.

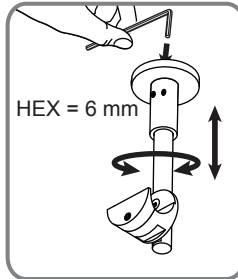

Turn base to raise or lower.

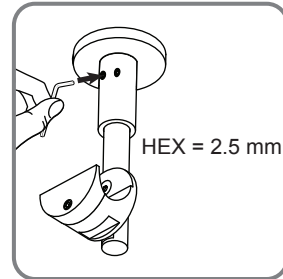

Tighten set screws.

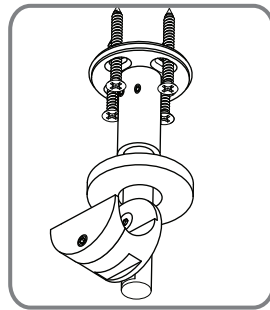
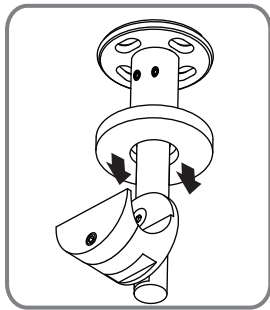

Slide trim plate down. Secure to ceiling with screws properly anchored to the substrate.

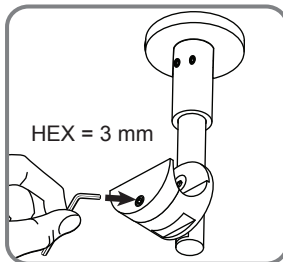

Loosen clamp to install sliding tube.

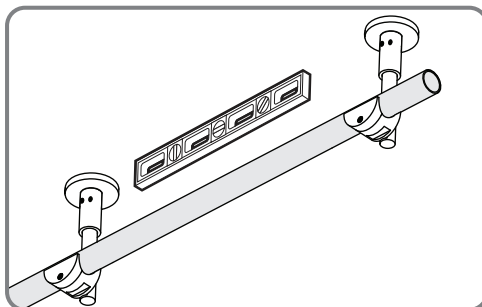
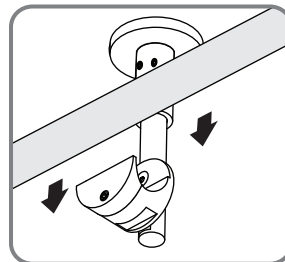

Ensure Sliding Tube is level.

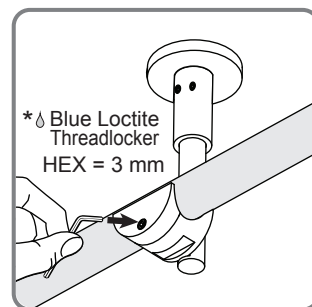

Tighten Clamp again.

\* Blue Loctite Threadlocker is recommended on all screw threads during final assembly.

## INSTALL ACCESSORIES (CONTINUED)

### Install Softbrake (Optional for Wall Mount Applications)

Cut Sliding Tube per instructions. Insert Left Softbrake with Left Door Stop into one end and Right Softbrake with Right Door Stop into the other. Follow instructions for Wall Mount Hardware on Pages 11 - 12, centering a Clamp at each joint. Continue on Pages 14 - 17 to finish the installation.

NOTE: When adjusting Anti-Lift height on Page 15 make sure it triggers Softbrake.

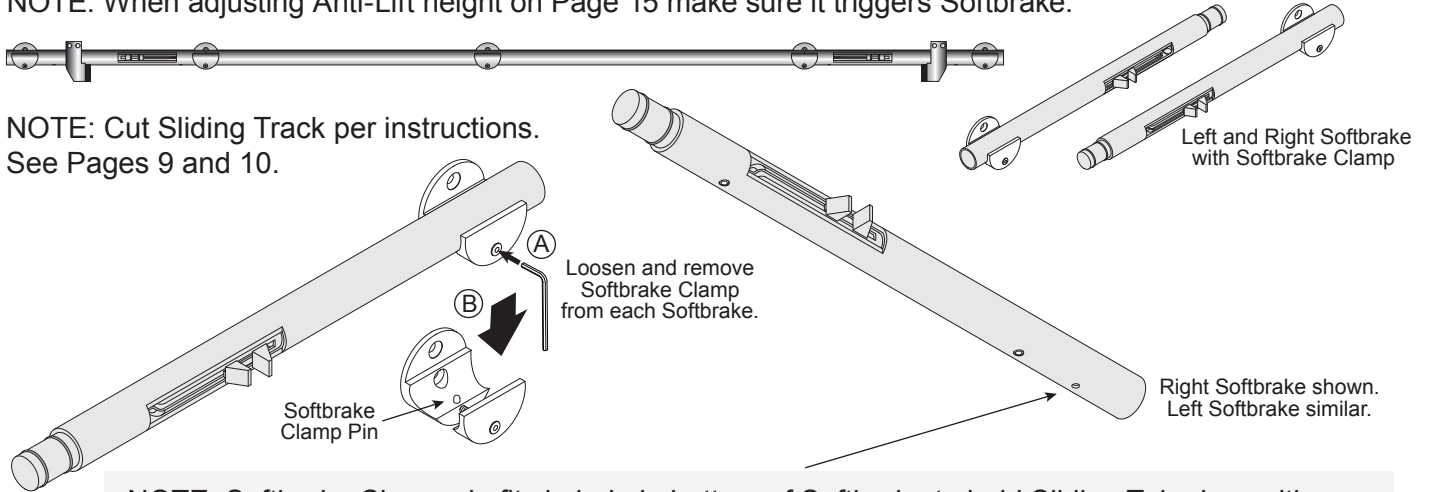

NOTE: Softbrake Clamp pin fits in hole in bottom of Softbrake to hold Sliding Tube in position. Install Softbrake Clamps after Wall Clamps are installed to ensure proper location. Follow Steps 1 through 4 on Pages 11 and 12 to install Wall Clamps and Sliding Tube.

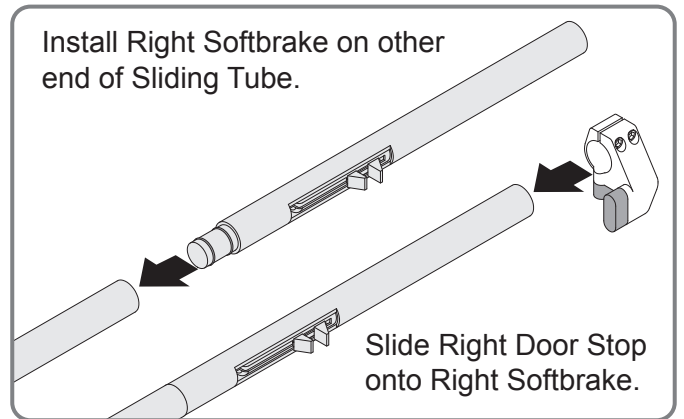
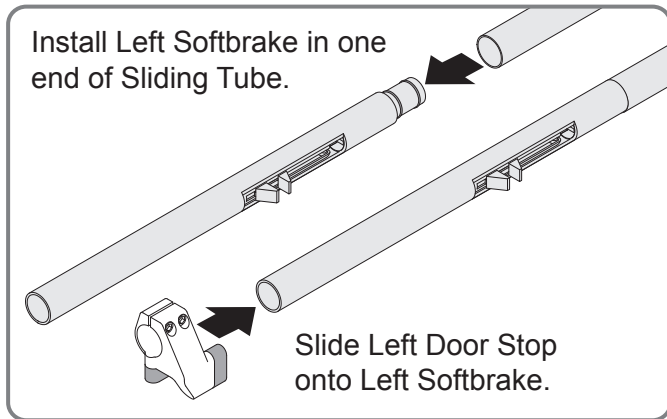

NOTE: For Bi-Parting Doors refer to hole location details on Page 10 for Clamp spacing. Butt Left and Right Softbrakes at center of opening. Center Wall Clamps at all other joints.

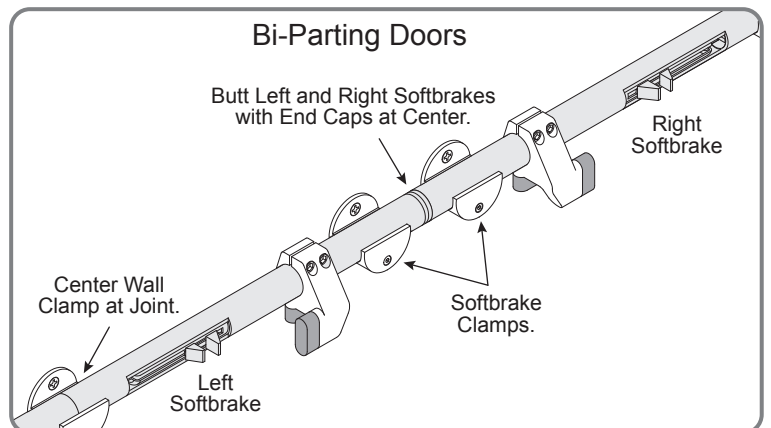
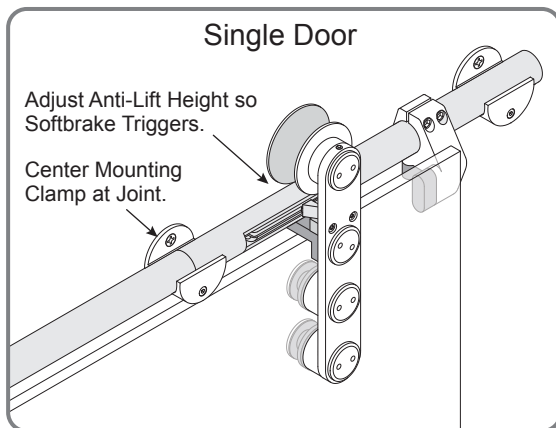

## MAINTENANCE

Inspect roller assemblies at routine intervals for smooth operation. Remove debris that might accumulate on the upper track surface. Assure that each roller assembly is straight and tight. Also check all spanner nuts and tighten if necessary. **Do not overtighten.** Glass fracturing could occur. Replace any glass panel that shows fracturing or chipping on edges or around drilled holes. Worn or broken components should be replaced immediately by qualified personnel.

Do not lubricate the track or rollers. Lubricants will attract dirt, creating a dirty roller surface and interfering with the system's smooth operation. See below for cleaning procedures.

## CARE AND CLEANING OF STAINLESS STEEL

Satin polished Stainless Steel is one of the most durable and easiest finishes to maintain. Although stainless steel is generally resistant to corrosion, the surface is susceptible to cosmetic deterioration by the effects of salt water and air-borne chemicals which may result in small brown spots appearing on its surface (this process is likely to be accelerated in coastal areas). These spots in no way affect the strength, integrity or longevity of the product, they are simply superficial discolorations that require cleaning to restore the stainless steel to its original appearance.

Stainless steel finishes should be cleaned with rubbing motions in the same direction as the grain texture with a foam spray cleaner, such as **CRL Cat. No. CRL841** Stainless Steel Polish & Cleaner, which cleans, polishes and protects stainless steel without hard rubbing and polishing. A coating of CRL841 resists finger prints, grease and water splatter and helps preserve the factory finish.

Wipe with a clean, dry cloth such as **CRL Cat. No. 1550** Lint-Free Glass Wipes, which are made with four plies of strong, white paper and reinforced in both directions with an extra ply of tough nylon. These highly absorbent rugged wipes will stand up to the most demanding shop work.

For repair of damaged finishes, satin stainless steel can be rubbed with one of the following abrasive pads:

**CRL Cat. No. SB7447F** - CRL 3M™ Scotch-Brite™ Fine Pad

Stainless steel finishes should be rubbed in the same direction as the grain texture.

For long term protection and use on repaired areas, CRL offers an unsurpassed surface treatment system specifically designed to protect both glass and stainless steel.

Visit [crlaurence.com](http://crlaurence.com) for more details.