

Revisions By:

CRL

2503 E. Vernon Avenue, Los Angeles, CA 90058-1897
PH: (800)-421-8144 FX: 800-587-7501 www.crlaurence.com

Description:
CRL GAS
GLASS AWNING SUPPORT SYSTEM

Drawn By:JO
Date: 02/08/2019
Scale: AS NOTED
File Name:
SYS0101A_GAS_GLASS_AWNING

Sheet

1

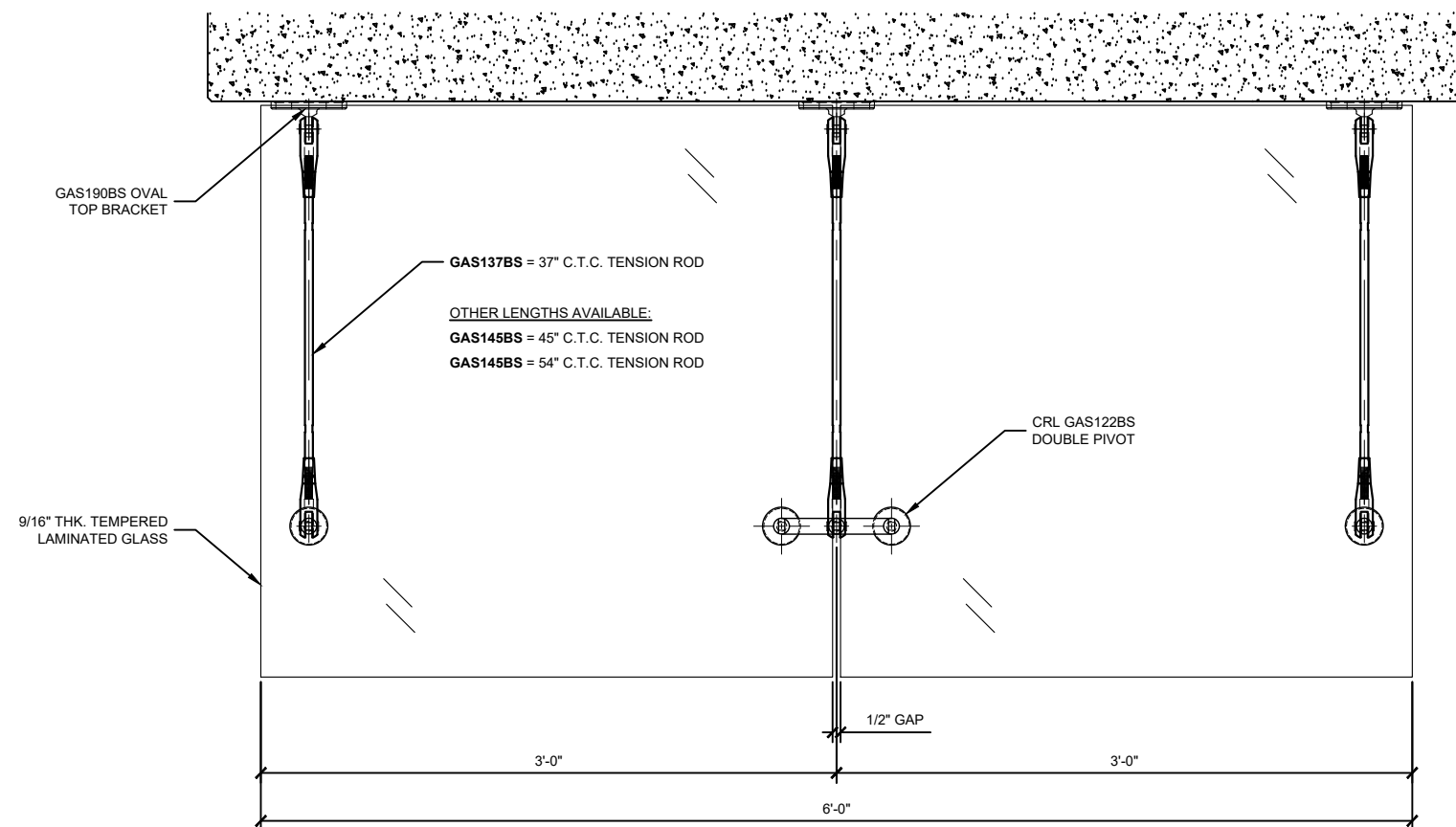

1 PLAN - TYPICAL GAS GLASS AWNING SYSTEM

Scale: 1 : 5

STRUCTURAL DISCLAIMER:

ALL CUSTOMERS WHO IN ANY WAY UTILIZE THIS PRODUCT ARE SOLELY RESPONSIBLE TO CONSULT A STRUCTURAL ENGINEER TO DETERMINE THE SUITABILITY OF THE PRODUCT FOR THE INTENDED USE AND SITE CONDITIONS. ALL INSTALLERS MUST BE QUALIFIED AND HAVE PROFESSIONAL KNOWLEDGE ABOUT COMPLIANCE WITH LOCAL, STATE AND FEDERAL REGULATIONS, SAFETY FACTORS, AND THE APPROPRIATE CHOICE OF FIXING MATERIAL AND PROCEDURES.

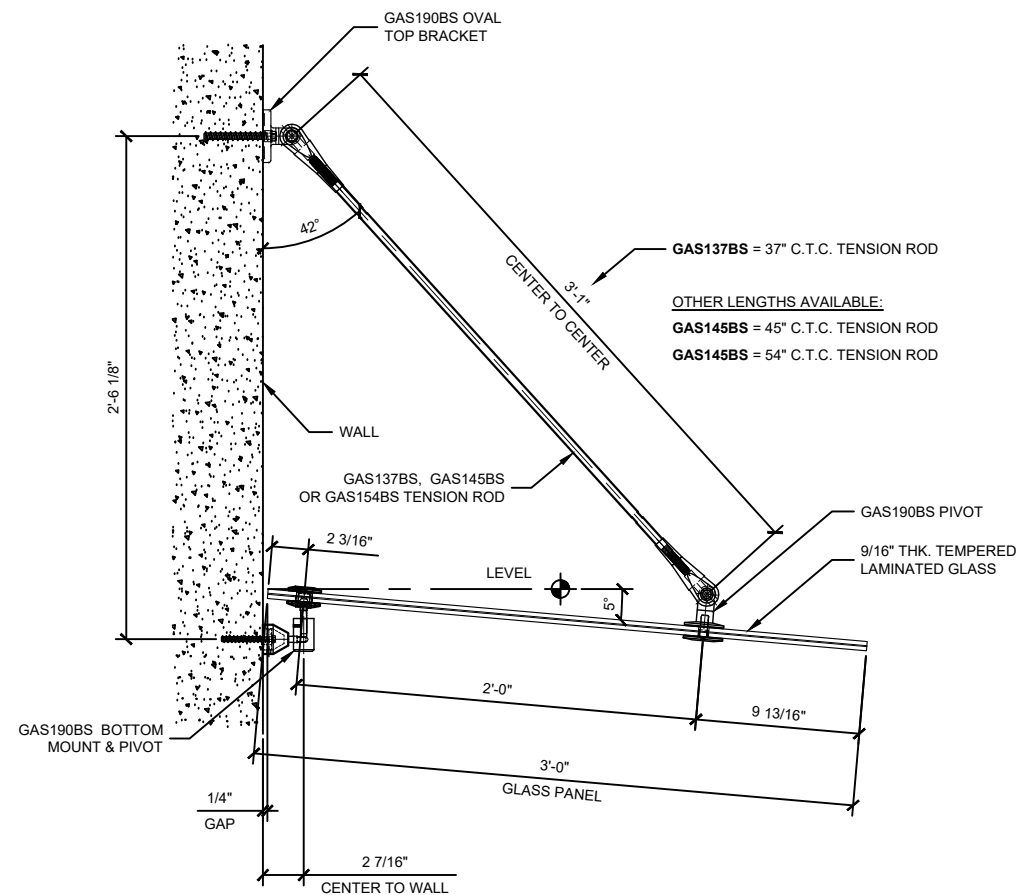

2 SECTION THRU 36" PANEL, 5° SLOPE w/37" LG. ROD

Scale: 1 : 5

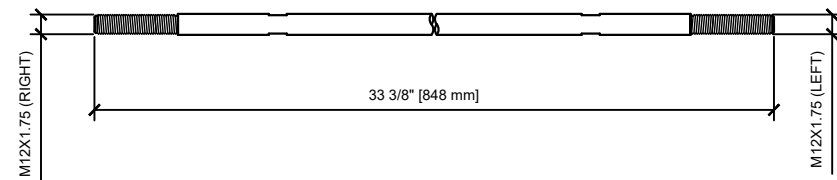
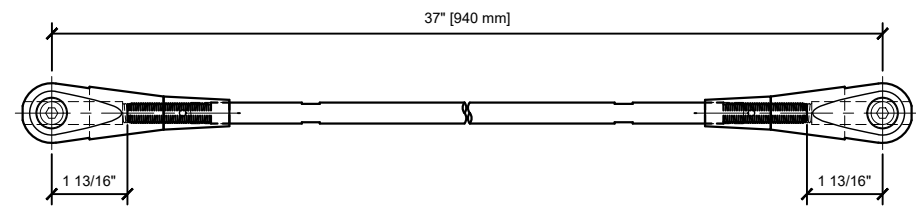

1 CRL GAS154BS - 37" C.T.C. TENSION ROD, BRUSHED SS FINISH
Scale: 6" = 1'-0"

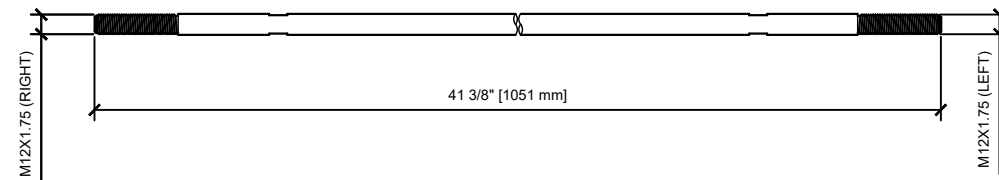
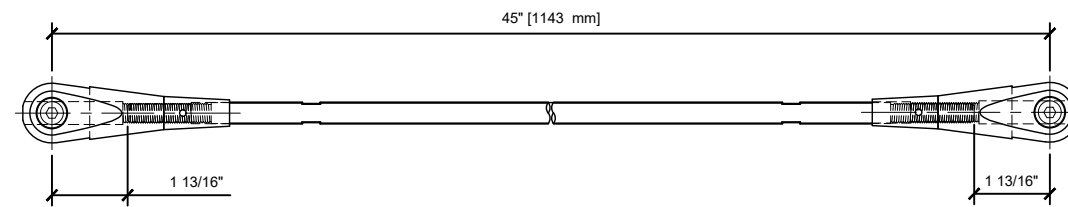

2 CRL GAS154BS - 45" C.T.C. TENSION ROD, BRUSHED SS FINISH
Scale: 6" = 1'-0"

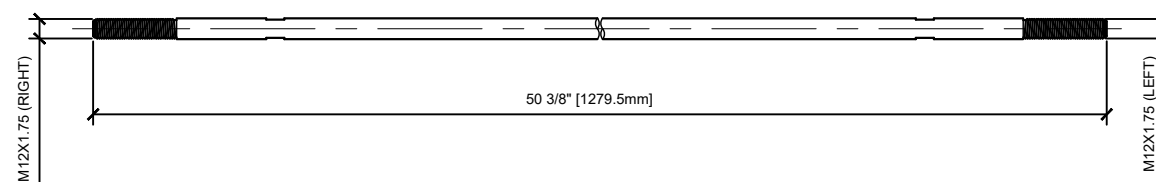
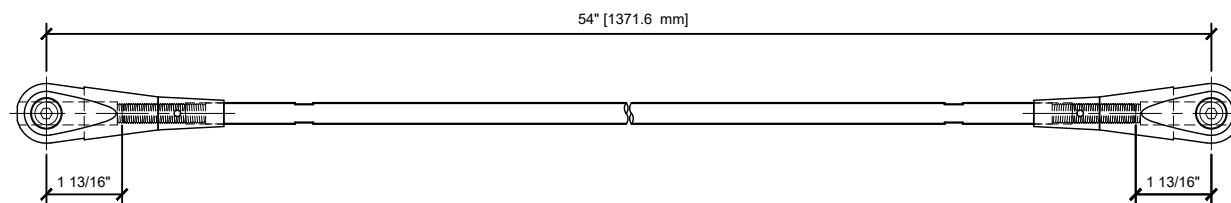

3 CRL GAS154BS - 54" C.T.C. TENSION ROD, BRUSHED SS FINISH
Scale: 6" = 1'-0"

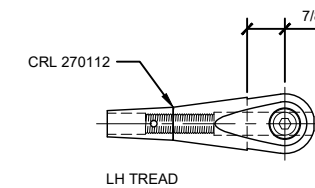
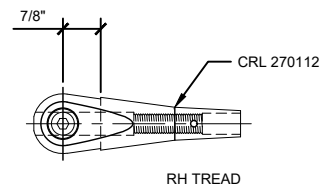

Revisions By:

CRL.

2503 E. Vernon Avenue, Los Angeles, CA 90058-1897
PH: (800)-421-8144 FX: 800-587-7501 www.crlaurence.com

Description:
CRL GAS
GLASS AWNING SUPPORT SYSTEM

Drawn By: JO
Date: 02/08/2019
Scale: AS NOTED
File Name:
SYS0101A_GAS_GLASS_AWNING

Sheet

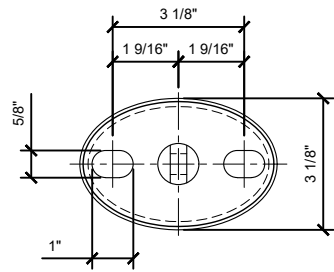

NOTE:
 TO ATTACH OVAL BRACKET FOR STEEL
 USE 5/8-18 HEX HEAD CAP SCREW
 WITH FLAT WASHER & LOCK WASHER.
 FOR CONCRETE USE CRL EBA334
 EXPANSION ANCHOR WITH OVERSIZE
 FLAT WASHER.

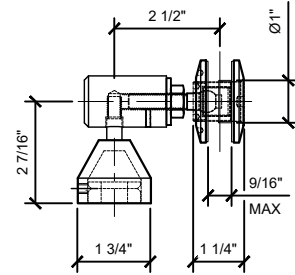
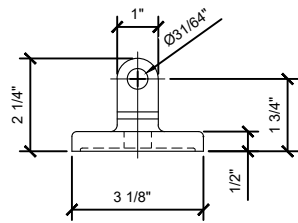
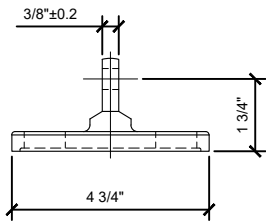

NOTE:
 TO ATTACH PIVOT BRACKET
 FOR STEEL, TAP FOR 3/8\"/>

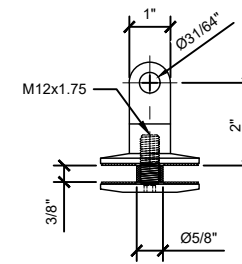
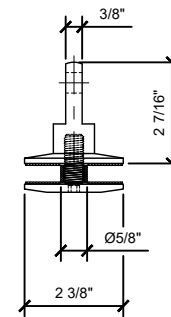

NOTE:
 5/8\"/>

1 CRL GAS190BS - GLASS AWNING SUPPORT SYSTEM MOUNTING KIT, BRUSHED SS FINISH Scale: 6" = 1'-0"

NOTE:
 5/8\"/>

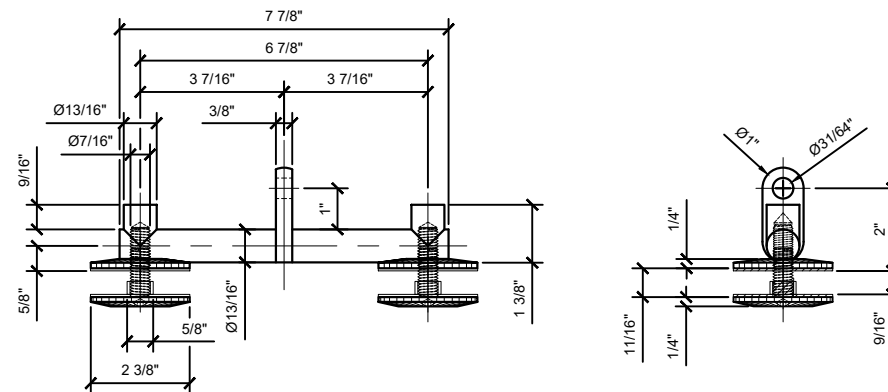

2 CRL GAS122BS - DOUBLE PLATE GLASS AWNING PIVOT BRUSHED SS FINISH Scale: 6" = 1'-0"

Revisions By:

CRL

2503 E. Vernon Avenue, Los Angeles, CA 90058-1897
 PH: (800)-421-6144 FX: 800-587-7501 www.crlaurence.com

Description:
 CRL GAS
 GLASS AWNING SUPPORT SYSTEM

Drawn By:JO
 Date: 02/08/2019
 Scale: AS NOTED
 File Name:
 SYS0101A_GAS_GLASS_AWNING

Sheet