

STRUCTURAL DISCLAIMER:

ALL CUSTOMERS WHO IN ANY WAY UTILIZE THIS PRODUCT ARE SOLELY RESPONSIBLE TO CONSULT A STRUCTURAL ENGINEER TO DETERMINE THE SUITABILITY OF THE PRODUCT FOR THE INTENDED USE AND SITE CONDITIONS. ALL INSTALLERS MUST BE QUALIFIED AND HAVE PROFESSIONAL KNOWLEDGE ABOUT COMPLIANCE WITH LOCAL, STATE AND FEDERAL REGULATIONS, SAFETY FACTORS, AND THE APPROPRIATE CHOICE OF FIXING MATERIAL AND PROCEDURES.

THE CRL LAGUNA PIVOT DOOR SYSTEM CAN BE USED WITH FREE-SWINGING DOORS, OR DOORS CONTROLLED BY FLOOR MOUNTED DOOR CLOSER. THE HARDWARE CAN BE ORDERED IN SETS OR BY INDIVIDUAL COMPONENTS.

CRL PROVIDES YOU WITH ALL OF THE GLASS FASTENERS FOR EITHER FLUSH MOUNTING, WHICH REQUIRES A COUNTERSUNK HOLE, OR SURFACE MOUNTING, WHERE A STRAIGHT HOLE IS NEEDED. THE GLASS FASTENERS WILL ACCOMMODATE EITHER 3/8" (10 MM) OR 1/2" (12 MM) TEMPERED GLASS. LAMINATED GLASS CANNOT BE USED WITH THIS TYPE OF HARDWARE.

STANDARDIZED SETS ALLOW EASY PLANNING AND PURCHASING FOR A NUMBER OF BASIC CONFIGURATIONS. AVAILABLE ACCESSORIES GIVE YOU THE OPPORTUNITY TO CUSTOMIZE THE STANDARD SETS TO ACCOMMODATE THE MOST IMAGINATIVE DESIGNERS.

THE LS14BS HARDWARE SET CONSISTS OF:
 1 EACH LS1BS FREE-SWINGING TOP PIVOT
 1 EACH LS5BS TOP AND BOTTOM PIVOT ROD SET
 (CLOSERS OR BOTTOM PIVOTS ARE SOLD SEPARATELY.)

NOTE: CARE SHOULD BE TAKEN WHEN USING THIS SYSTEM IN EXTERIOR APPLICATIONS TO ENSURE THAT AIR AND WATER INFILTRATION CAN BE MINIMIZED. THESE FITTINGS ARE NOT FOR USE WITH LAMINATED GLASS

SYSTEM LIMITATIONS:
 MAXIMUM DOOR WEIGHT: 176 LBS. (80 KG)
 MAXIMUM PANEL WIDTH: 47-1/4" (1.2 M)
 MAXIMUM PANEL HEIGHT: 98-7/8" (2.5 M)

.\L3DLENPC\LS14BS_46691[1].gif

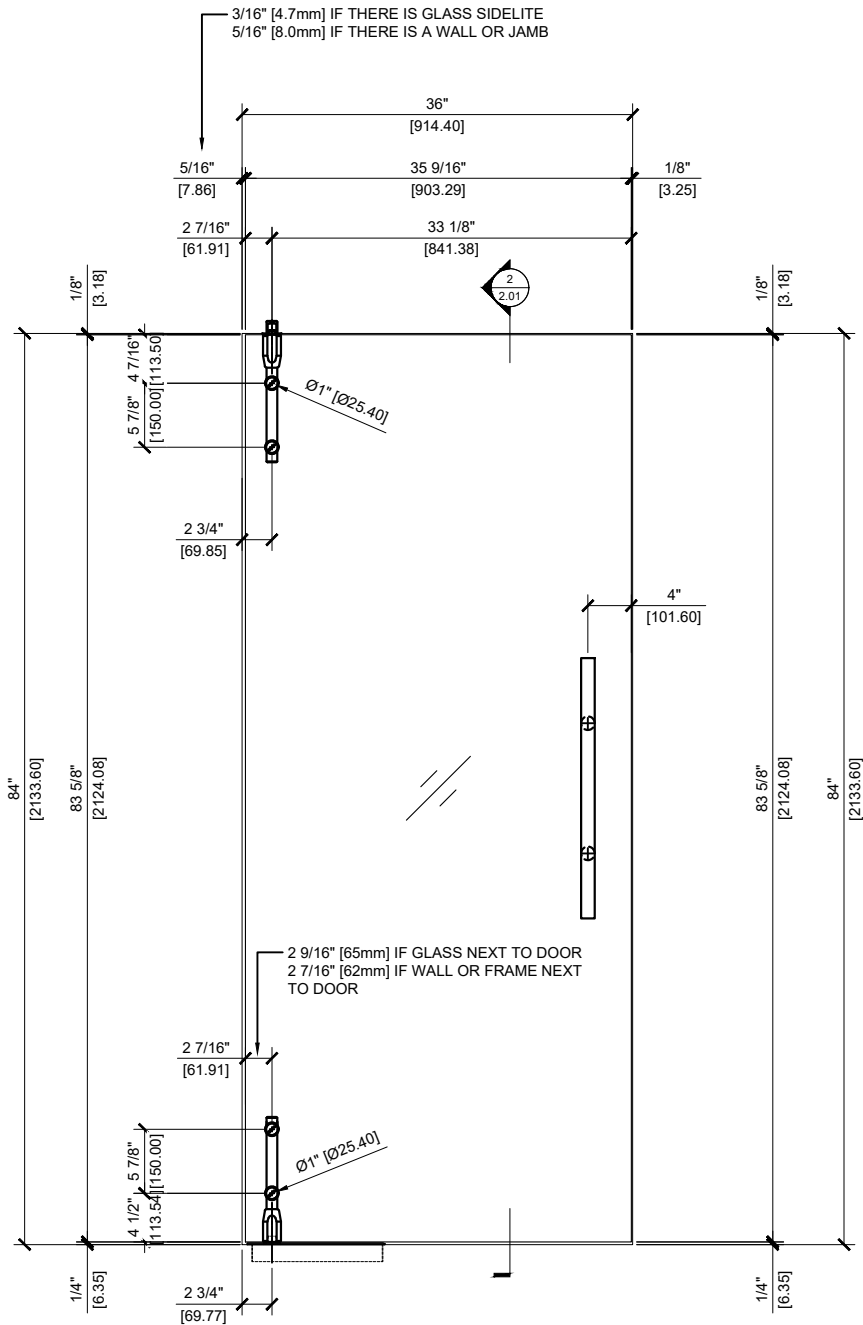

① LS14BS ELEVATION
 ARCH REF: 1-1/2"=1'-0"

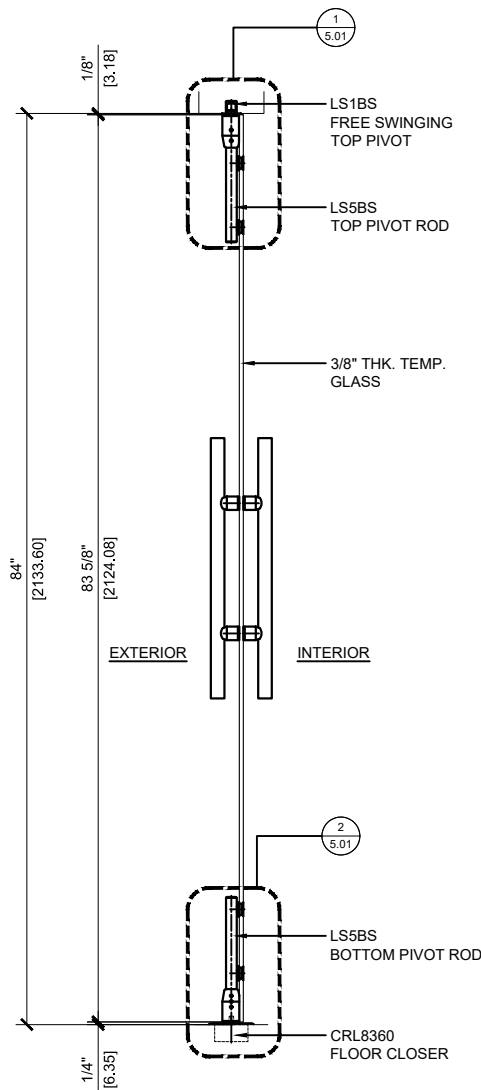

② LS14BS SECTION W/ 3/8" GL
 ARCH REF: 1-1/2"=1'-0"

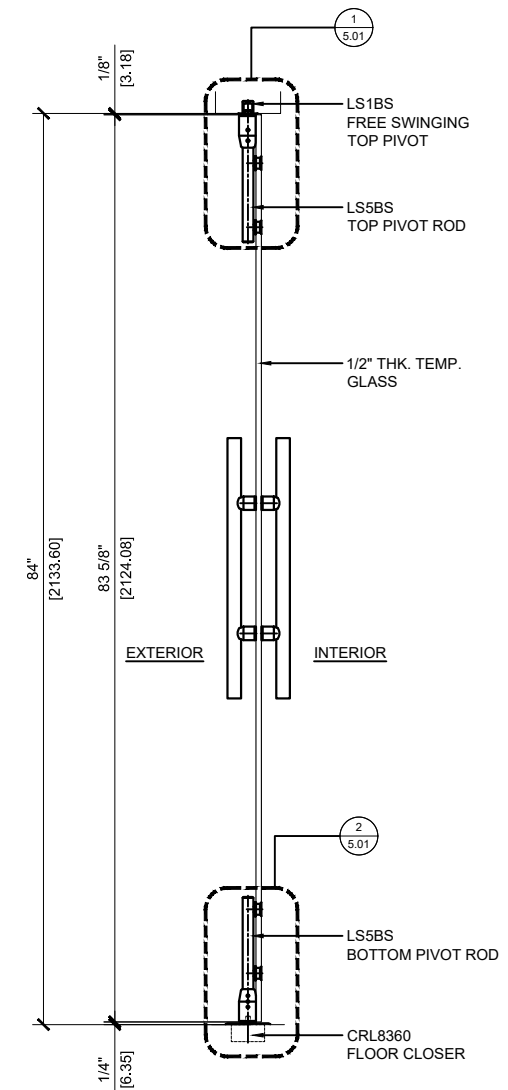

③ LS14BS SECTION W/ 1/2" GL
 ARCH REF: 1-1/2"=1'-0"

Revisions By:



A CRL COMPANY
 2503 E. Vernon Avenue, Los Angeles, CA 90058-1897
 PH (800)-421-6144 FX: 800-597-7501 www.crlaurence.com

Description:
 CRL 4210
 LAGUNA SERIES
 PIVOT DOOR SYSTEM
 FOR 3/8" & 1/2" GLASS

Drawn By: CRL
 Date: 01/31/19
 Scale: AS NOTED
 File Name:
 SYS0045K_4210_LAGUNA_PIVO
 Sheet

STRUCTURAL DISCLAIMER:

ALL CUSTOMERS WHO IN ANY WAY UTILIZE THIS PRODUCT ARE SOLELY RESPONSIBLE TO CONSULT A STRUCTURAL ENGINEER TO DETERMINE THE SUITABILITY OF THE PRODUCT FOR THE INTENDED USE AND SITE CONDITIONS. ALL INSTALLERS MUST BE QUALIFIED AND HAVE PROFESSIONAL KNOWLEDGE ABOUT COMPLIANCE WITH LOCAL, STATE AND FEDERAL REGULATIONS, SAFETY FACTORS, AND THE APPROPRIATE CHOICE OF FIXING MATERIAL AND PROCEDURES.

THE CRL LAGUNA PIVOT DOOR SYSTEM CAN BE USED WITH FREE-SWINGING DOORS, OR DOORS CONTROLLED BY FLOOR MOUNTED DOOR CLOSER. THE HARDWARE CAN BE ORDERED IN SETS OR BY INDIVIDUAL COMPONENTS.

CRL PROVIDES YOU WITH ALL OF THE GLASS FASTENERS FOR EITHER FLUSH MOUNTING, WHICH REQUIRES A COUNTERSUNK HOLE, OR SURFACE MOUNTING, WHERE A STRAIGHT HOLE IS NEEDED. THE GLASS FASTENERS WILL ACCOMMODATE EITHER 3/8" (10 MM) OR 1/2" (12 MM) TEMPERED GLASS. LAMINATED GLASS CANNOT BE USED WITH THIS TYPE OF HARDWARE.

STANDARDIZED SETS ALLOW EASY PLANNING AND PURCHASING FOR A NUMBER OF BASIC CONFIGURATIONS. AVAILABLE ACCESSORIES GIVE YOU THE OPPORTUNITY TO CUSTOMIZE THE STANDARD SETS TO ACCOMMODATE THE MOST IMAGINATIVE DESIGNERS.

THE LS24BS HARDWARE SET CONSISTS OF:
 1 EACH LS2BS TRANSOM MOUNTED FREE-SWINGING TOP PIVOT
 1 EACH LS5BS TOP AND BOTTOM PIVOT ROD SET
 (CLOSERS OR BOTTOM PIVOTS ARE SOLD SEPARATELY.)

NOTE: CARE SHOULD BE TAKEN WHEN USING THIS SYSTEM IN EXTERIOR APPLICATIONS TO ENSURE THAT AIR AND WATER INFILTRATION CAN BE MINIMIZED. THESE FITTINGS ARE NOT FOR USE WITH LAMINATED GLASS

SYSTEM LIMITATIONS:
 MAXIMUM DOOR WEIGHT: 176 LBS. (80 KG)
 MAXIMUM PANEL WIDTH: 47-1/4" (1.2 M)
 MAXIMUM PANEL HEIGHT: 98-7/8" (2.5 M)

.\L3DLENPC\LS24BS_46692[1].gif

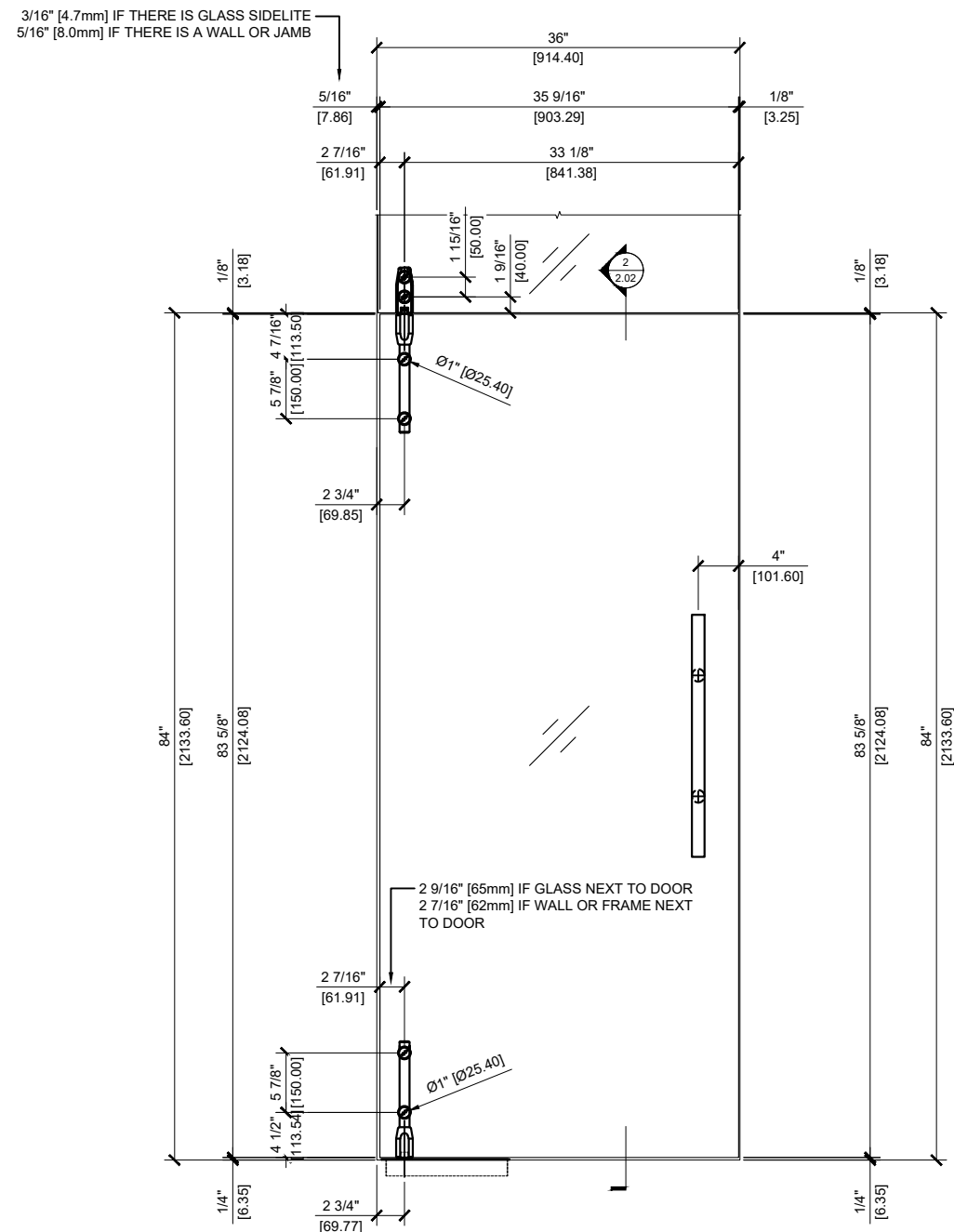

① LS24BS ELEVATION
 ARCH REF: 1-1/2"=1'-0"

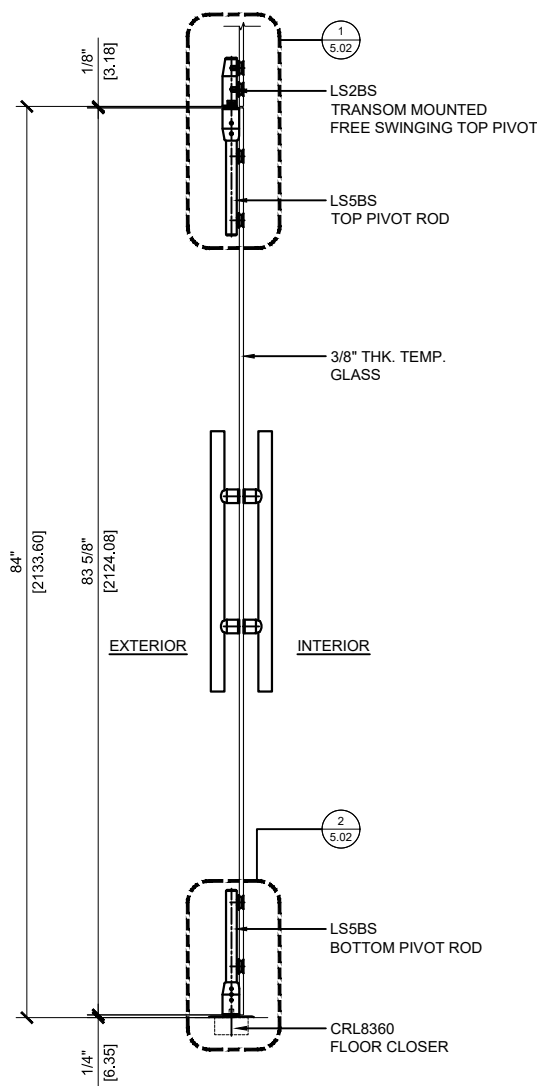

② LS24BS SECTION W/ 3/8" GL
 ARCH REF: 1-1/2"=1'-0"

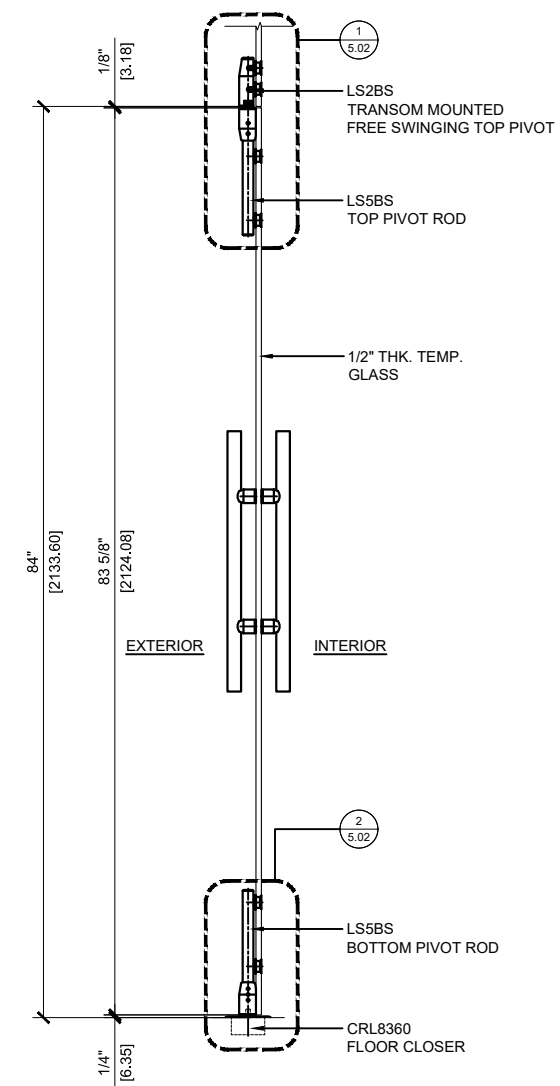

③ LS24BS SECTION W/ 1/2" GL
 ARCH REF: 1-1/2"=1'-0"

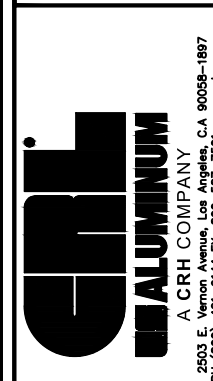

Description:
 CRL 4210
 LAGUNA SERIES
 PIVOT DOOR SYSTEM
 FOR 3/8" & 1/2" GLASS

Drawn By: CRL
 Date: 01/31/19
 Scale: AS NOTED
 File Name:
 SYS0045K_4210_LAGUNA_PIVO
 Sheet

STRUCTURAL DISCLAIMER:

ALL CUSTOMERS WHO IN ANY WAY UTILIZE THIS PRODUCT ARE SOLELY RESPONSIBLE TO CONSULT A STRUCTURAL ENGINEER TO DETERMINE THE SUITABILITY OF THE PRODUCT FOR THE INTENDED USE AND SITE CONDITIONS. ALL INSTALLERS MUST BE QUALIFIED AND HAVE PROFESSIONAL KNOWLEDGE ABOUT COMPLIANCE WITH LOCAL, STATE AND FEDERAL REGULATIONS, SAFETY FACTORS, AND THE APPROPRIATE CHOICE OF FIXING MATERIAL AND PROCEDURES.

THE CRL LAGUNA PIVOT DOOR SYSTEM CAN BE USED WITH FREE-SWINGING DOORS, OR DOORS CONTROLLED BY FLOOR MOUNTED DOOR CLOSER. THE HARDWARE CAN BE ORDERED IN SETS OR BY INDIVIDUAL COMPONENTS.

CRL PROVIDES YOU WITH ALL OF THE GLASS FASTENERS FOR EITHER FLUSH MOUNTING, WHICH REQUIRES A COUNTERSUNK HOLE, OR SURFACE MOUNTING, WHERE A STRAIGHT HOLE IS NEEDED. THE GLASS FASTENERS WILL ACCOMMODATE EITHER 3/8" (10 MM) OR 1/2" (12 MM) TEMPERED GLASS. LAMINATED GLASS CANNOT BE USED WITH THIS TYPE OF HARDWARE.

STANDARDIZED SETS ALLOW EASY PLANNING AND PURCHASING FOR A NUMBER OF BASIC CONFIGURATIONS. AVAILABLE ACCESSORIES GIVE YOU THE OPPORTUNITY TO CUSTOMIZE THE STANDARD SETS TO ACCOMMODATE THE MOST IMAGINATIVE DESIGNERS.

THE LS34BS HARDWARE SET CONSISTS OF:
 1 EACH LS3BS TRANSOM/SIDELITE FREE-SWINGING TOP PIVOT
 1 EACH LS5BS TOP AND BOTTOM PIVOT ROD SET
 (CLOSERS OR BOTTOM PIVOTS ARE SOLD SEPARATELY)

NOTE: CARE SHOULD BE TAKEN WHEN USING THIS SYSTEM IN EXTERIOR APPLICATIONS TO ENSURE THAT AIR AND WATER INFILTRATION CAN BE MINIMIZED. THESE FITTINGS ARE NOT FOR USE WITH LAMINATED GLASS

SYSTEM LIMITATIONS:
 MAXIMUM DOOR WEIGHT: 176 LBS. (80 KG)
 MAXIMUM PANEL WIDTH: 47-1/4" (1.2 M)
 MAXIMUM PANEL HEIGHT: 98-7/8" (2.5 M)

.\5PVHQEGZLS34BS_46653[1].gif

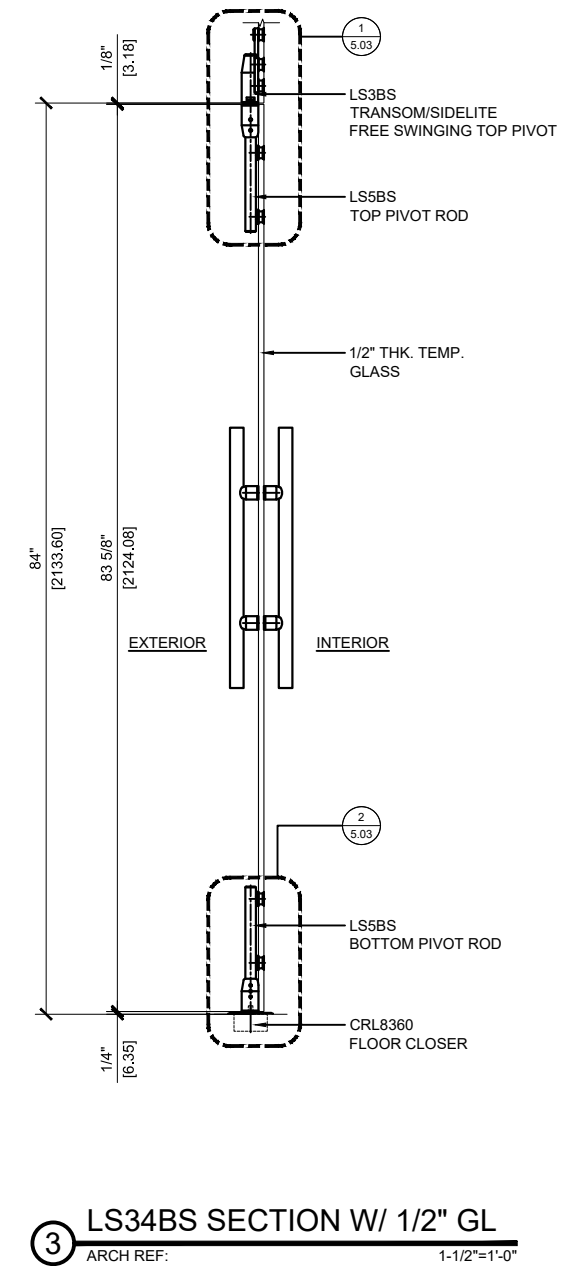
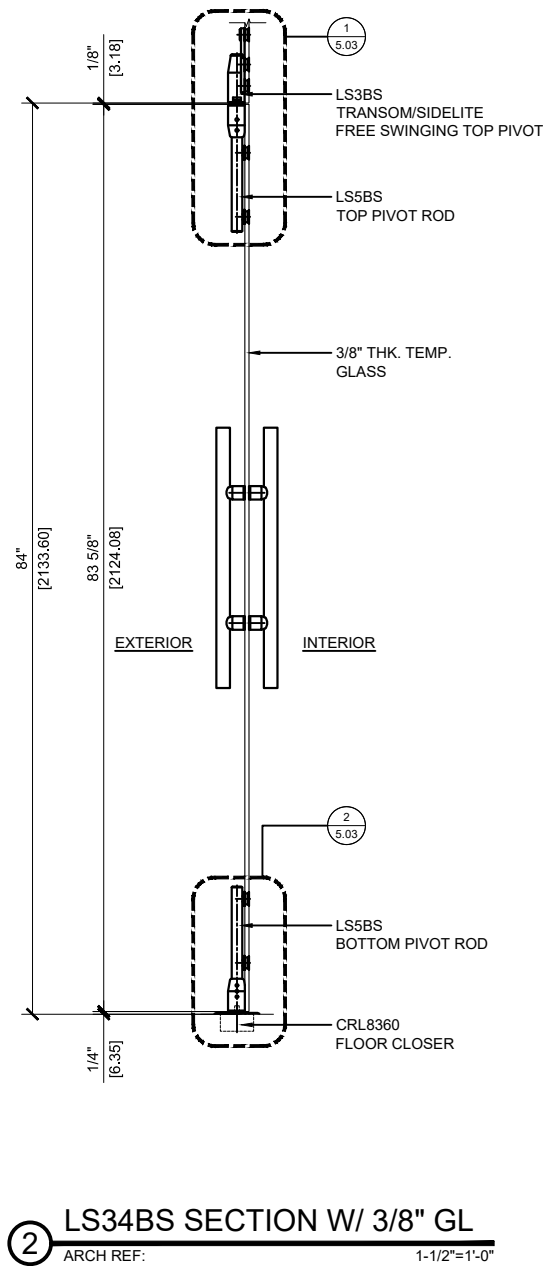
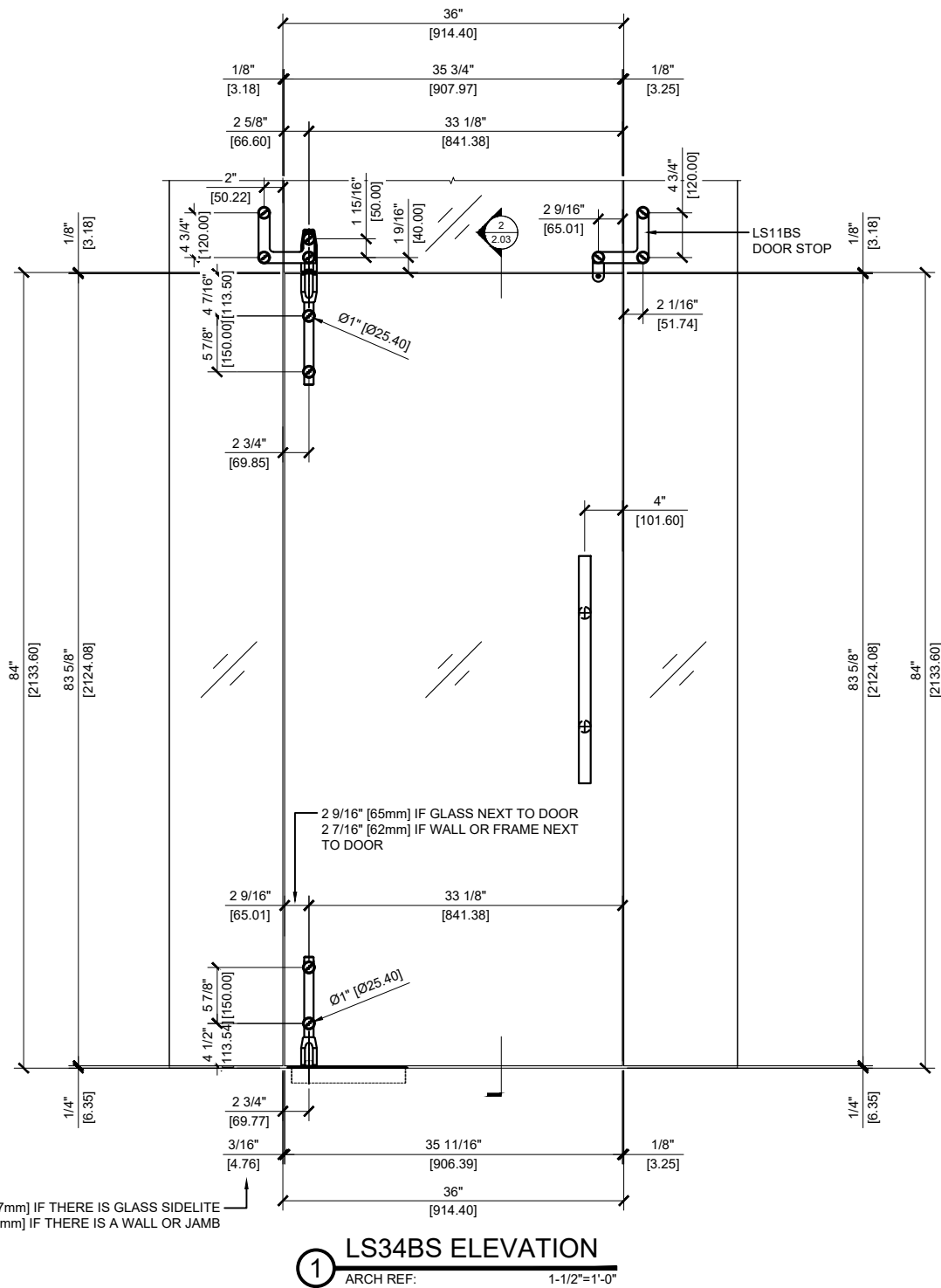



A CRL COMPANY
 2503 E. Vernon Avenue, Los Angeles, CA 90058-1897
 PH (800)-421-6144 FX: 800-597-7501 www.crlaluminum.com

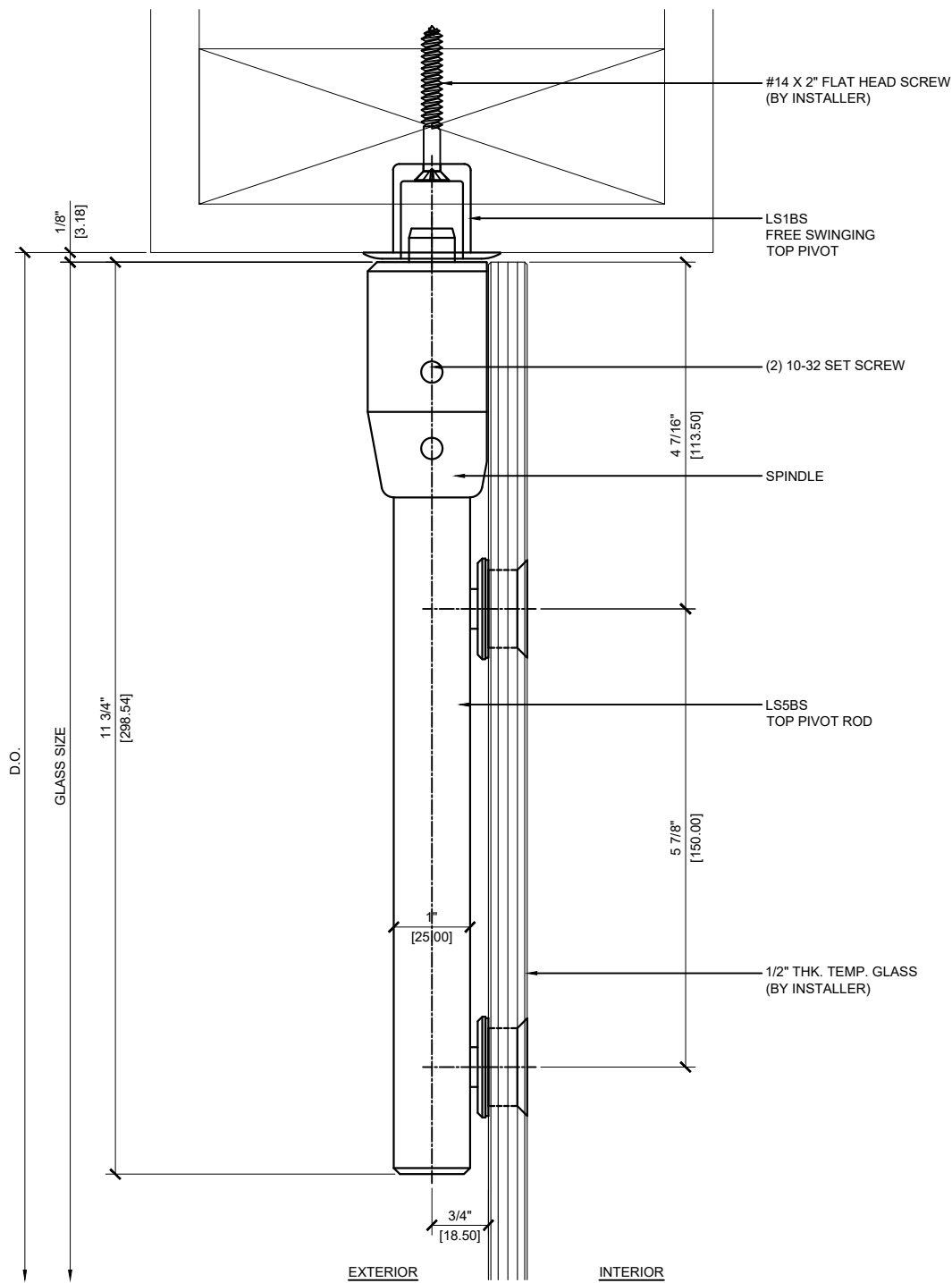

① LS14BS TOP PIVOT DETAIL
 ARCH REF: 1'-0"=1'-0"

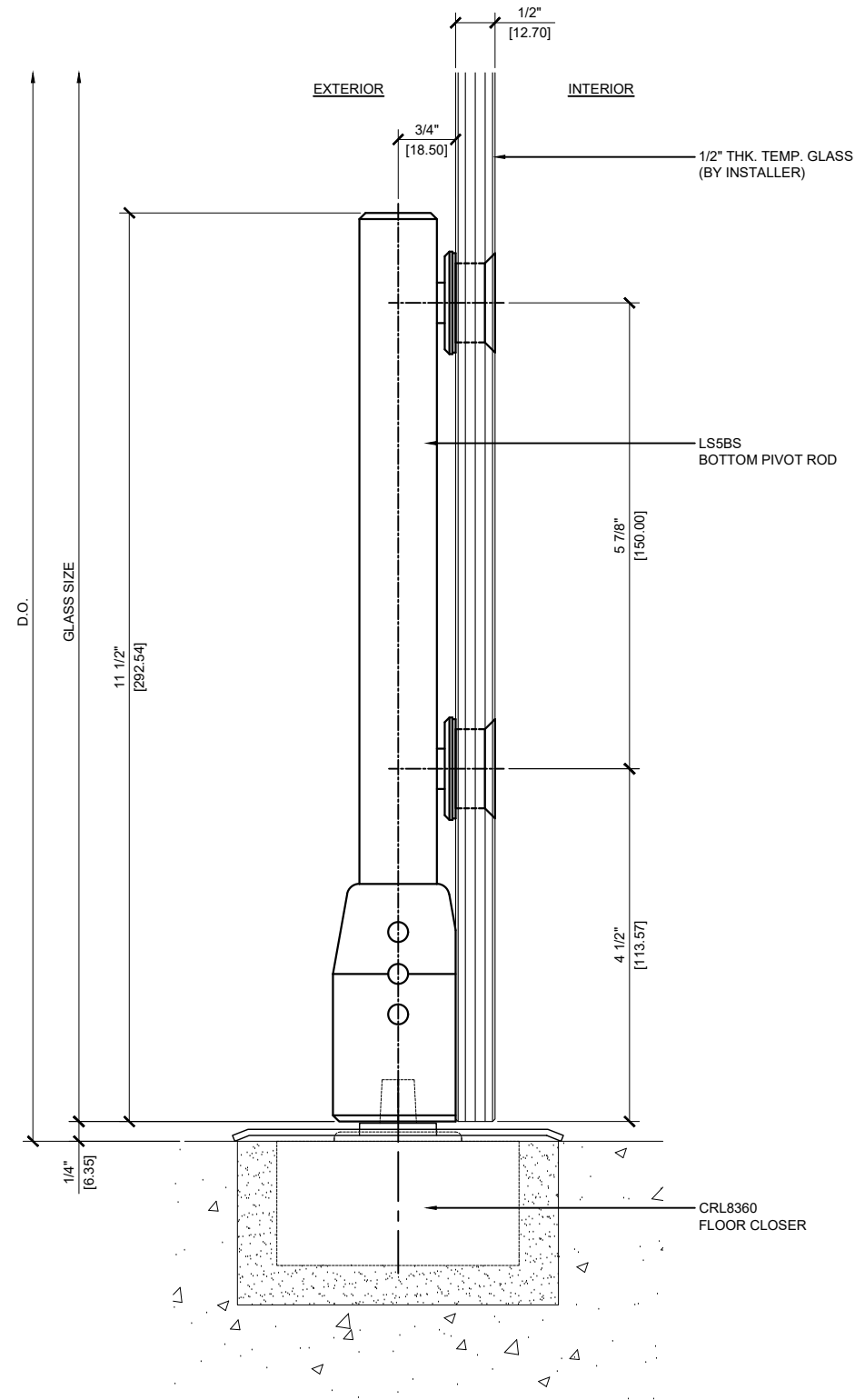

② LS14BS BOTTOM PIVOT DETAIL
 ARCH REF: 1'-0"=1'-0"

FLUSH MOUNT FABRICATION

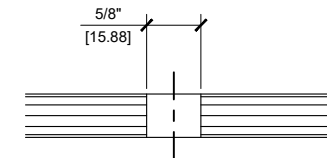

SURFACE MOUNT FABRICATION

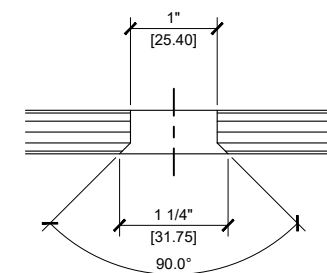

Description:

CRL 4210
 LAGUNA SERIES
 PIVOT DOOR SYSTEM
 FOR 3/8" & 1/2" GLASS

Drawn By: CRL

Date: 01/31/19

Scale: AS NOTED

File Name:

SYS0045K_4210_LAGUNA_PIVO

Sheet



A CRL COMPANY
 2503 E. Vernon Avenue, Los Angeles, CA 90058-1897
 PH (800)-421-6144 FX: 800-597-7501 www.crlaluminum.com

Description:

CRL 4210
 LAGUNA SERIES
 PIVOT DOOR SYSTEM
 FOR 3/8" & 1/2" GLASS

Drawn By: CRL

Date: 01/31/19

Scale: AS NOTED

File Name:

SYS0045K_4210_LAGUNA_PIVO

Sheet

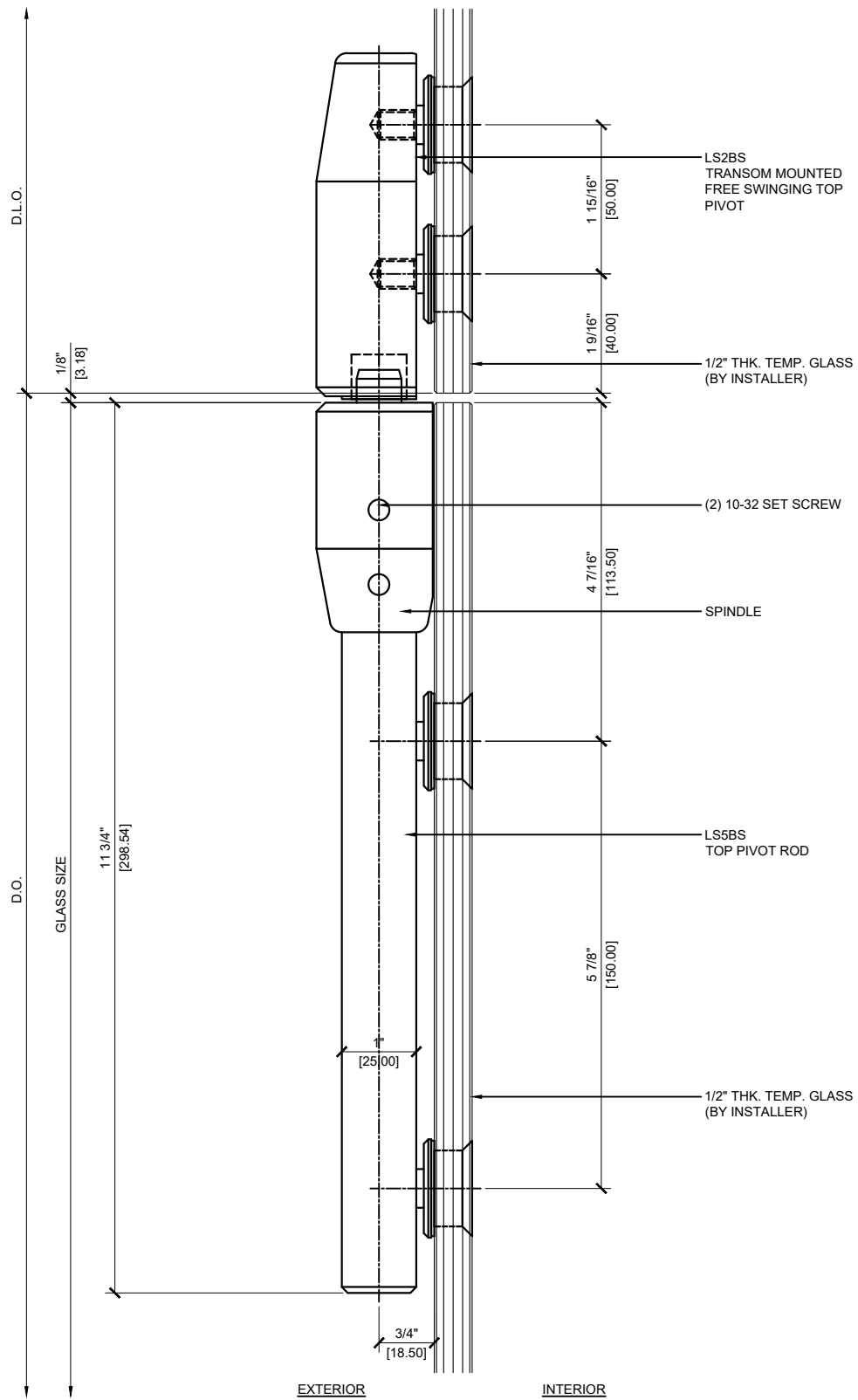

① LS24BS TOP PIVOT DETAIL
 ARCH REF: 1'-0"=1'-0"

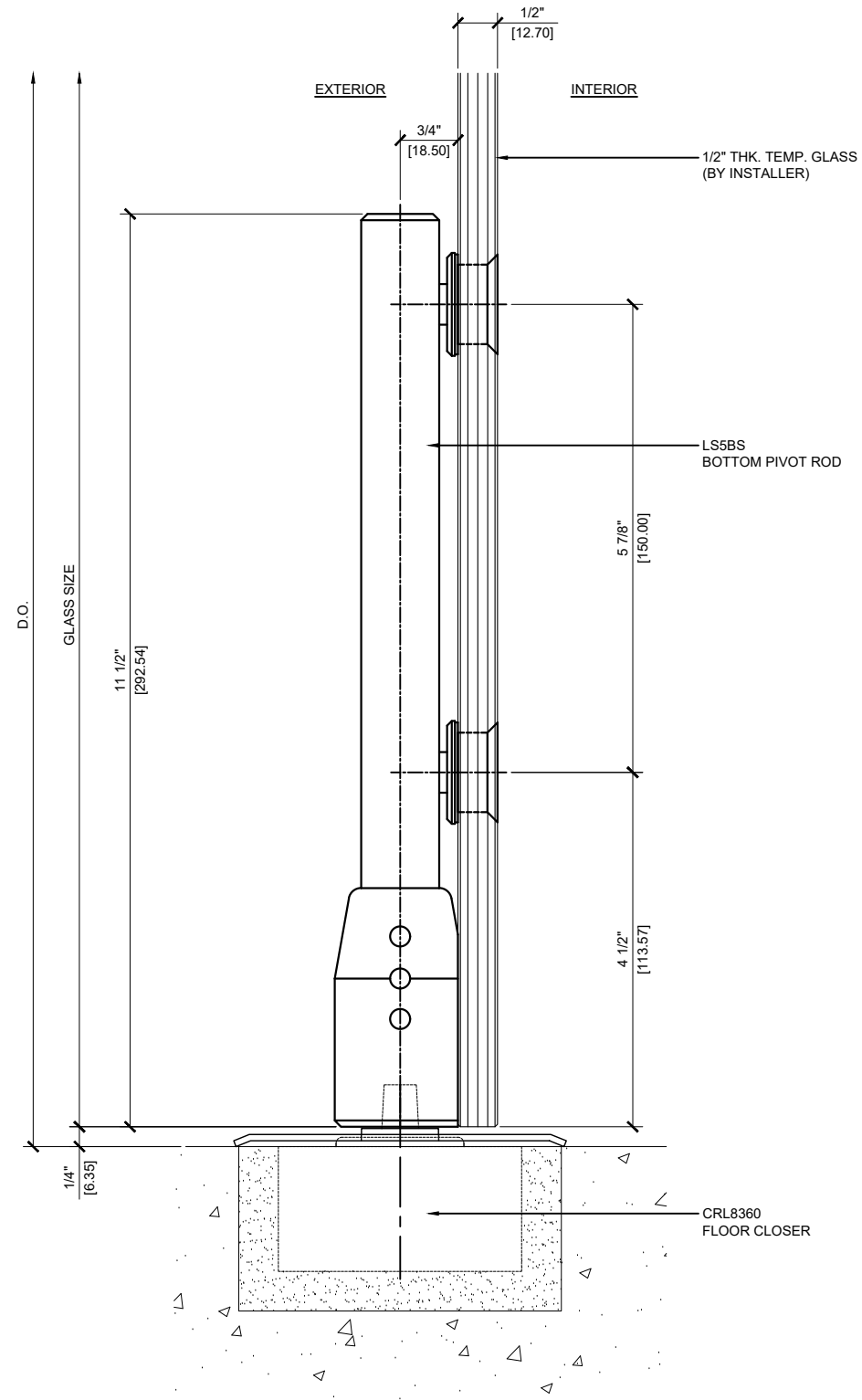

② LS24BS BOTTOM PIVOT DETAIL
 ARCH REF: 1'-0"=1'-0"

FLUSH MOUNT FABRICATION

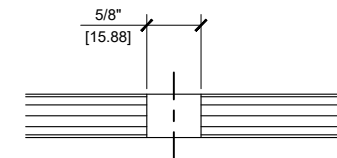

SURFACE MOUNT FABRICATION

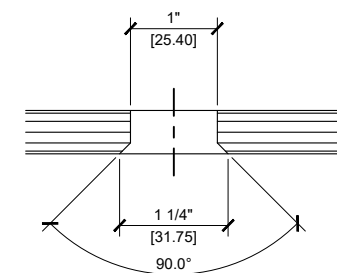



A CRL COMPANY
 2503 E. Vernon Avenue, Los Angeles, CA 90058-1897
 PH (800)-421-6144 FX: 800-597-7501 www.crlaurence.com

Description:

CRL 4210
 LAGUNA SERIES
 PIVOT DOOR SYSTEM
 FOR 3/8" & 1/2" GLASS

Drawn By: CRL

Date: 01/31/19

Scale: AS NOTED

File Name:

SYS0045K_4210_LAGUNA_PIVO

Sheet

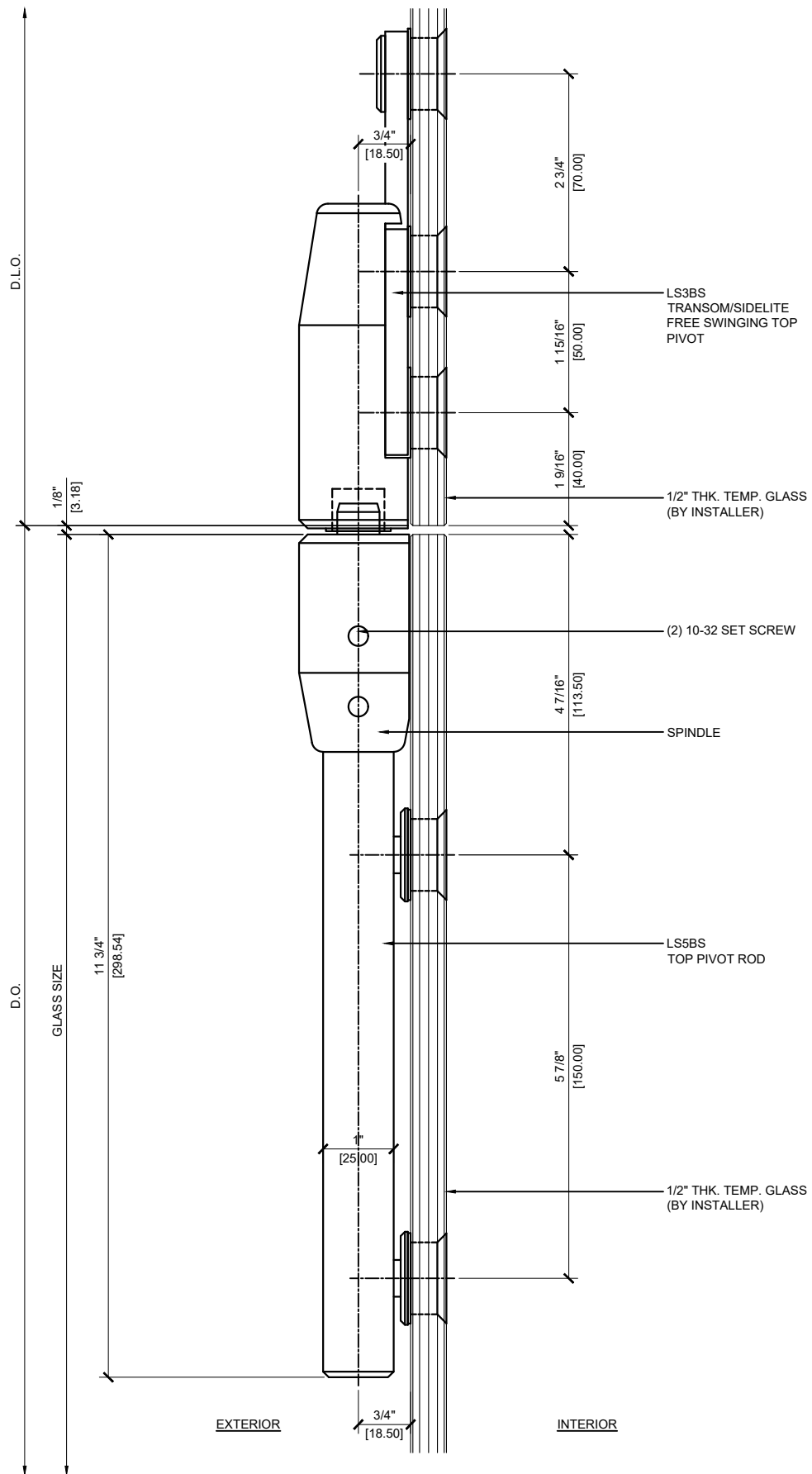

1 LS34BS TOP PIVOT DETAIL

ARCH REF: 1'-0"=1'-0"

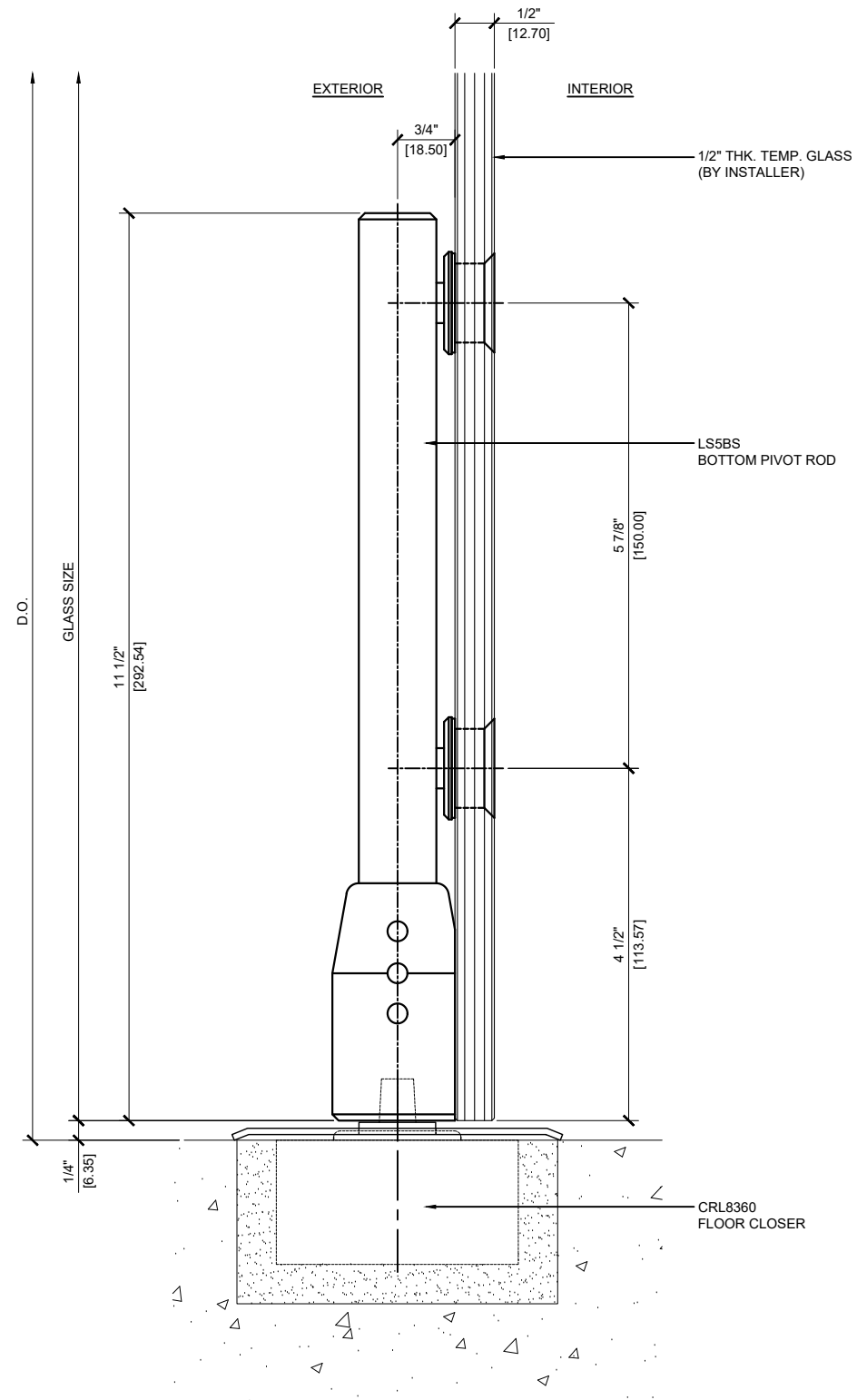

2 LS34BS BOTTOM PIVOT DETAIL

ARCH REF: 1'-0"=1'-0"

FLUSH MOUNT FABRICATION

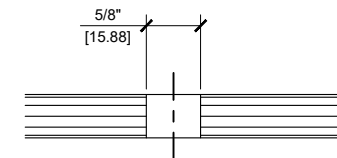

SURFACE MOUNT FABRICATION

