



- Compliance with International Codes
- Compliance to State/Regional Codes

ICC-ES Evaluation Report

ESR-3842

Reissued March 2023

Revised April 2023

This report is subject to renewal March 2024.

DIVISION: 05 00 00—METALS
Section: 05 52 00—Metal Railings
Section: 05 73 13—Glazed Decorative Metal Railings

DIVISION: 08 00 00—OPENINGS
Section: 08 81 00—Glass Glazing
Section: 08 88 00—Special Function Glazing

DIVISION: 32 00 00—EXTERIOR IMPROVEMENTS
Section: 32 35 00—Screening Devices

REPORT HOLDER:

C.R. LAURENCE COMPANY, INC.

EVALUATION SUBJECT:

GRS™ GLASS BALUSTRADE GUARD SYSTEM FOR LAMINATED TEMPERED GLASS APPLICATIONS

1.0 EVALUATION SCOPE

Compliance with the following codes:

- 2021, 2018, 2015, 2012, 2009 and 2006 *International Building Code*® (IBC)
- 2021, 2018, 2015, 2012, 2009 and 2006 *International Residential Code*® (IRC)

For evaluation for compliance with codes adopted by Los Angeles Department of Building and Safety (LADBS), see [ESR-3842 LABC and LARC Supplement](#).

Properties evaluated:

- Structural
- Durability

2.0 USES

The GRS™ (Glass Railing Systems) for laminated glass are used as guardrail systems in interior and exterior locations of all construction types.

The GRS™ (Glass Railing Systems) have been demonstrated as compliant for use in IBC Section 2407.1.4, Wind-Borne Debris Regions when installed in accordance with this report and with a minimum laminated glass panel thickness of 9/16 inch (14.3 mm), a minimum 0.06 inch (1.52 mm) thick ionoplast SentryGlas® interlayer, and a top rail.

3.0 DESCRIPTION

3.1 General:

The GRS™ typically consists of a top rail or handrail, laminated glass panels, and base shoe. The glass panel is either dry glazed using the Taper-Loc® system or wet glazed using grout. Figure 1 shows the typical elevation with the components. Figure 6 shows a typical wet glazed installation. Refer to Section 3.1.6 for grout requirements. Figure 8 shows the CRL Taper-Loc® dry glaze systems.

3.1.1 Top Rail: The top rails (also known as cap rails) are manufactured from 304 or 316 stainless steel, brass C26000 alloy, or aluminum alloy 6063-T5/T6. See Table 3.

3.1.2 Handrail: The handrails are supported by brackets installed on the sides of the laminated glass panels.

The brackets HR15G, HR20G, HR2D, HR2E, HR2F, HR2J, HR2S, HR3E, and HR5E are manufactured from 316 stainless steel, brass C26000 alloy, or aluminum alloy 6063. See Figure 10.

The handrails are manufactured from ASTM A53-12 Grade A or B galvanized steel, 304 or 316 stainless steel (unless otherwise noted), brass C26000 alloy or aluminum alloy 6063-T6:

- 1 1/4-inch Schedule 40 pipe – galvanized steel, stainless steel, aluminum
- 1 1/2-inch Schedule 40 pipe – galvanized steel, stainless steel aluminum
- 1 1/2-inch OD x 1/8-inch tube – stainless steel [1/16 hard, F_y ≥ 45 ksi (310 MPa)], aluminum, brass C26000
- 1 1/2-inch OD x 0.05-inch tube – stainless steel [1/16 hard, F_y ≥ 45 ksi (310 MPa)], brass C26000
- 2-inch OD x 0.05-inch tube – stainless steel [1/16 hard, F_y ≥ 45 ksi (310 MPa)], brass C26000.

3.1.3 Laminated Glass Panels: The laminated glass panels must comply with ASTM C1172 and Category II of CPSC 16 CFR 1201 or ANSI Z97.1. The panels must consist of two lites of glass with an interlayer.

For nominal laminated panel thicknesses of 9/16, 11/16, 13/16, and 1 1/16 inches, the minimum thickness must be 0.498, 0.644, 0.770, and 0.998 inch (12.6, 16.4, 19.6 and 25.3 mm), respectively.

The lites must be Kind FT tempered glass complying with ASTM C1048 and have a minimum Modulus of Rupture (F_r) $\geq 24,000$ psi (165 MPa).

The interlayer must be a minimum of 0.060 inch (1.52mm) thick. The interlayer may be a non-PVB or PVB interlayer. The interlayer shear modulus (G) must comply with the values listed in the appropriate tables of this report.

For use in wind-borne debris regions, the ionoplast SentryGlas® (non-PVB) interlayer must be used and must have an interlayer shear modulus (G) greater than 1,640 psi (11.3 MPa) for temperatures less than or equal to 122°F (50°C).

When top rail or handrail is not used, glass panels must be specified to have exposed edges polished, fully laminated to edge and glass plies flush. Post-temper edge polishing is allowed. Glass plies must be of equal thickness. See Section 5.3 of the Conditions of Use.

3.1.4 Base Shoe: The L56S, L68S, L21S, L25S, 9BL56, 9BL68 and 9BL21 base shoes are manufactured from 6063-T52 aluminum. See Figure 2.

3.1.5 Taper-Loc®: The Taper-Loc® system components are manufactured from nylon and may be used with any of the base shoes in this report when paired with the corresponding glass thickness. See Figure 8.

3.2 Durability:

The materials incorporated in the system described in this report are inherently corrosion resistant. The material type specified must be appropriate for the environment of the installation. Information verifying the durability must be submitted to the code official, when requested.

4.0 DESIGN AND INSTALLATION

4.1 General:

Installation of the guardrail system, including the handrails and top rails, must comply with the manufacturer's published instructions, this report, and the IBC or IRC, as applicable.

The manufacturer's published installation instructions must be available at the jobsite at all times during installation. In the event of a conflict between this report and the manufacturer's instructions, this report governs.

H_g = Total guard height from bottom of base shoe to top of top rail or glass where no top rail is used.

H_c = Glass cantilever height from top of base shoe to top of top rail or glass where no top rail is used.

4.1.1 Loading: The applicable project specific loads must be identified:

- A live load of 50 plf (0.73 kN/m) applied in any direction along the handrail or top rail (not applicable under the IRC).
- A single concentrated live load of 200 lb (0.89 kN) applied in any direction at any point on the handrail or top rail.
- A horizontally applied normal live load of 50 lb (0.22 kN) applied perpendicular to the glass panel on an area not to exceed 12 in. by 12 in. (305 mm by 305 mm).
- Wind load in psf.

4.1.2 Laminated Glass Panels:

The allowable live load stress is the modulus of rupture (F_r) divided by a safety factor of 4 [$24,000/4 = 6,000$ psi (41.3 MPa)].

The allowable wind load stress is 9600 psi (66.2 MPa).

Tables 1A through 1D provides allowable wind pressures based on the allowable wind load stress and the interlayer shear modulus (G).

Tables 1A through 1D provides maximum glass cantilever height (H_c) based on as allowable live load stress of 6,000 psi (41.3 MPa) in column 10 and based on the effective thickness for deflection and 1 inch (25.4 mm) deflection in column 11.

Tables 1A through 1D provides maximum allowable glass cantilever height (H_c), column 10 based on the allowable live load bending stress of 6,000 psi (41.3 MPa) and column 11 for a deflection limit of 1 inch (25.4 mm).

Tables 1A through 1D provide the effective thicknesses which may be used for determining stress and deflections. The effective thicknesses are based on the interlayer shear modulus (G).

Table 4 provides the maximum glass panel height when installed without a top rail.

Minimum spacing between glass panels is $1/4$ -inch (6.4 mm) for nominal $9/16$ -inch and nominal $11/16$ -inch thick glass panels and $1/2$ -inch for nominal $13/16$ -inch thick glass panels.

4.1.2.1 Holes and Notches: Holes and notches are permitted for mounting handrails. Holes and notches must conform to ASTM C1048 and must not exceed 2 inches wide (50.8 mm). Notches or holes must not exceed $1/12$ th of the glass width. Holes or notches must not be located within the first third of the glass panel (balustrade) height from the base shoe.

4.1.3 Base Shoes: Details of the connections of the bases shoes that are either surface mounted or fascia mounted to steel, concrete, and wood substrates are included in C.R. Laurence's drawings titled "GRS Glass Railing System for Tempered Laminated $9/16$ ", $11/16$ ", $13/16$ " & $11/16$ " thick Glass" dated March 1, 2017.

The appropriate base shoe must be selected based on glass thickness, installation method, and loading (see Figure 2). The end anchor must be installed within 12 inches (305 mm) of the end of the base shoe and no less than $1 1/2$ inches (38 mm) to the centerline of the anchor.

Table 2 provides the allowable wind loads for the base shoes and anchorages. Table 2 also provides the maximum height (H_c) for the base shoes and anchorages based on a live load of 50 plf (0.73 kN/m).

A minimum of two anchors are required for any base shoe section.

When base shoes are attached to drainage block, the drainage block must not be a dissimilar metal.

4.1.3.1 Steel Substrate: L56S and 9BL56 base shoes must be attached to a minimum ASTM A36 steel member with a minimum thickness of $1/4$ -inch (6.4 mm) using a $1/2$ -inch diameter by $3/4$ -inch long (12.7 mm by 19.1 mm) ASTM F-837 Alloy Group 1 (any condition), stainless steel socket head cap screws into tapped holes. L68S, L21S, L25S, 9BL68 and 9BL21 base shoes must be attached using a M14 ϕ -2.0 x 20mm 304 stainless steel Hex Head Screws with 28mm outside diameter stainless steel washer. When installed in a through-bolt condition the cap screw length must be increased to a length sufficient to permit proper installation with full engagement in the nut.

4.1.3.1.1 Surface Mounted to Steel: The allowable wind loads are provided in Table 2.

4.1.3.1.2 Fascia Mounted to Steel: The allowable wind loads are provided in Table 2.

4.1.3.2 Concrete Substrate: The base shoe must be attached to the concrete substrate with minimum compression strength of 2,500 psi (17.2 MPa), and in an uncracked condition or 4,000 psi (27.6 MPa) in a cracked condition, using either screw-in Hilti HUS-EZ (KH-EZ) anchors in accordance with ESR-3027, or Hilti HSL-3 anchors in accordance with ESR-1545.

L56S and 9BL56 base shoe anchors must be HUS-EZ $\frac{3}{8}$ inch-by-4 inches or HSL-3 M8 with a minimum 3-inch (76 mm) embedment.

L68S, L21S, L25S, 9BL68 and 9BL21 base shoes anchors must be HUS-EZ $\frac{1}{2}$ inch-by-4 inches or HSL-3 M12 with a minimum 3-inch (76 mm) embedment.

Minimum anchor spacing is 5.91 inches (150 mm) for HUS-EZ or HSL-3 M8 anchors and 11.82 inches (300 mm) for HSL-3 M12 anchors.

For 11.82-inches (300 mm) on center anchor spacing, anchor locations may be moved to avoid reinforcement provided the same number of anchors are provided and no two anchors are closer than 6-inches (152 mm) on center.

For cracked concrete with strength f_c under 4,000 psi (27.6 MPa) multiply the allowable loads in Table 2 by 0.71.

Anchor lengths assume base shoe is in direct contact with concrete, anchor length must be increased for any material between the base shoe and concrete surface.

4.1.3.2.1 Adjustment of Allowable Wind Load for the Uncracked Condition: For concrete compressive strength between 3000 psi (20.6 MPa) and 5,000 psi (34.4 MPa), the allowable wind loads in Table 2 may be increased by applying the following adjustment factor (c_w):

$$c_w = \sqrt{(f_c/2500)}$$

$$W' = c_w * W$$

W = allowable wind load from Table 2, psf

W' = adjusted allowable wind load, psf

f_c = concrete compressive strength, psi

4.1.3.2.2 Adjustment of Allowable Wind Loads for Sand Lightweight Concrete: When installed into sand lightweight concrete, the allowable wind loads from Table 2 must be reduced by multiplying by a factor of 0.6.

4.1.3.2.3 Surface Mounted: For concrete edge distances equal to or greater than 3.75 inches (95 mm) (concrete edge measured parallel to the centerline of anchor), the allowable wind loads must be as provided in Table 2 for the corresponding guard height (H_g).

For concrete edge distances less than 3.75 inches (95 mm) and up to including 1.75 inches (44.5 mm), the allowable wind load in Table 2 must be reduced for edge distances $3.75 \text{ inches} > e \geq 1.75 \text{ inches}$ by multiplying allowable moment strength and allowable wind load by $\sqrt{e/3.75}$.

For L56S and 9BL56 base shoes, the minimum slab or wall thickness must be 5 inches (127 mm) when using the $\frac{3}{8}$ -inch (9.5 mm) diameter HUS or HSL-3 anchors.

For L68S, L21S, L25S, 9BL68 and 9BL21 base shoes using $\frac{1}{2}$ -inch (12.7 mm) diameter HUS and HSL-3 M12 anchors, minimum slab thickness is 6.75 inches (171 mm).

Anchor end distance must be more than half of specified anchor spacing.

Minimum wall thickness is 6.95 inches (177 mm) for anchors installed on top of wall.

4.1.3.2.3.1 When the base shoe is installed over drainage blocks or solid shims 2 inches (50.8 mm) long by the full base shoe width at each anchor point the allowable wind loads in Table 2 must be multiplied by 0.94.

4.1.3.2.4 Fascia-mounted: When the base shoe is fascia-mounted to a slab edge, beam, wall or similar condition the minimum concrete thickness must be 6 inches (152 mm). The top and bottom of the base shoe must not extend past the concrete edge.

4.1.3.2.4.1 Fascia-mounted over Drainage Blocks: When the base shoe is installed with metal drainage blocks 2-inches (51 mm) wide by 4-inches (102 mm) deep at each anchor point, the allowable wind loads in Table 2 must be reduced by multiplying by 0.8.

4.1.3.3 Wood Substrate: Wood must have a have a specific gravity, G , greater than 0.49. Fasteners must be tightened so that the base shoe is in tight contact to the supporting wood. The wood substrate must comply with the applicable provisions of the applicable code.

4.1.3.3.1 Surface Mounted:

4.1.3.3.1.1 Attached to Wood Substrate Subject to Moisture Content ≥ 19 percent: The tabulated values in Table 2 are not applicable for this condition. The values presented in this section (Section 4.1.3.3.1.1) must be used for design. The base shoe must be attached to the wood substrate using steel or aluminum brackets or a continuous angle. All base shoe fasteners must be 304 or 316 stainless steel.

When attaching the base shoes to aluminum or steel brackets that are attached to the wood substrate as specified and shown in Figures 3 and 4, the allowable moment and allowable wind load is:

Allowable Moment: $M_a = 2,773 \text{ lb-in/ft}$

36-inch Guard height (H_g): $W = 46.7 \text{ psf}$

42-inch Guard height (H_g): $W = 34.3 \text{ psf}$

When attaching the base shoes to continuous angles that are attached to the wood substrate as specified below, the allowable moment and allowable wind load is:

Allowable Moment: $M_a = 5,562 \text{ lb-in/ft}$

42-inches Guard height - $W = 68.8 \text{ psf}$

- The angles must be $L5 \times 5 \times \frac{5}{16}$ inch and comply with ASTM A36 with a G90 galvanization or 6063 T5 aluminum.

- The base shoe is connected to the steel angle with $\frac{1}{2}$ -inch diameter by $\frac{3}{4}$ -inch long (12.7 mm by 19.1 mm) ASTM F-837 Alloy Group 1 (any condition), stainless steel socket head cap screws into tapped holes spaced 12 inches o.c. (305 mm)

- The attachment of the angle to the wood substrate must with minimum No.14x3-inch (76 mm) stainless steel wood screws spaced 3 inches (76 mm) on center along each leg.

4.1.3.3.1.2 Attached to Wood Substrate Subject to Moisture Content < 19 percent: The surface mounted base shoes are directly attached to wood substrates which must have a compressive strength perpendicular to the grain $\geq 625 \text{ psi}$ (4.1 MPa). L56S and 9BL56 base shoes must be fastened with $\frac{3}{8}$ -inch-diameter (9.5 mm) x 5-inches (127 mm) lag screws with spacing per Table 2, and all other listed base shoes must be anchored with $\frac{1}{2}$ -inch-diameter (12.7 mm) x 6-inches (152 mm) lag screws with spacing per Table 2.

4.1.3.3.1.2.1 IRC Applications [(200 pounds (0.89 kN) Top Rail Live Load only): For a 200 lb (0.89 kN) load and a balustrade length greater than 10 feet (3.048 m), the fasteners used to attach the base shoe to the wood substrate must be installed at a maximum 23.64-inches (600 mm) on center. However, for a balustrade length of 10'-0" long or less, the minimum number of fasteners is: four (4) for 36-inch (914 mm) guard height (H_g) and five (5) for a 42-inch (1067 mm) guard height.

4.1.3.3.1.2.2 Locations Subject to 50 plf [0.73 kN/m]-top rail live load per IBC Section 1607.8.1: For a 50 plf (0.73 kN/m) load applied at a 36-inch (914 mm) guard height (H_g) or 42-inch (1067 mm) guard height and a balustrade length of 4 feet or less (1.22m), the minimum number of fasteners used to attach the base shoe to wood substrate must be five (5).

4.1.3.3.1.2.3 Other Locations exempted from the 50 plf [0.73 kN/m] top rail live load: Locations allowed in IBC 1607.8.1 Exception 2 are subject to a 20 plf (0.29 kN/m) load and 200 pounds (0.89 kN) Top Rail Live Load nonconcurrently. When installed in these locations the fasteners must be installed as noted in 4.1.3.3.1.2.1.

4.1.3.3.2 Fascia Mounted – Attached to Wood Substrate Subject to Moisture Content \geq 19 percent or Moisture Content $<$ 19 percent: The base shoes must be attached with $\frac{1}{2}$ -inch-diameter (12.7 mm) x 4-inch (102 mm) long lag screws installed directly to the wood substrate with spacing's as shown in Table 2. The top of the base shoe must be flush with or below the top of the wood substrate's corner radius and the wood substrate must extend below the bottom of the base shoe.

For exterior locations installed with drain blocks, fastener spacing must be 5.91 inches (150mm) o.c. with all listed base shoe except the L56S / 9BL56 base shoes (which must be 6 inches on center) and the allowable wind load in Table 2 must be reduced by 0.75.

4.1.4 Top Rails:

4.1.4.1 Installation with a Top Rail: The top rail profiles are shown in Figure 7. The maximum glass panel widths in Table 3 are based capacities of the top rails. If the end panel width exceeds the value shown in Table 3, the top rail must be attached to a wall or post or the end panel must meet the requirements for installation without a top rail.

The top rail must be installed so as to remain in place in the event of the failure of any one glass panel. This requires the use of a minimum of three glass panels or a combination of other top rail supports and glass panels totaling a minimum of three. Figure 5 illustrates the top rail support conditions. The top rail end condition (Figure 5) must be checked to verify that the rail will remain in place in the event of failure of the end glass panel. End support must be designed when required for a code-compliant installation. The stabilizing end cap shown in Figure 13 is an acceptable method of end support.

This section need not apply if the design is completed per Section 4.1.4.2.

4.1.4.2 Installation Without a Top Rail or Handrail:

When installed/designed without a top rail or handrail, the glass panel widths and heights must be as shown in Table 4 except that the differential deflection at the top of the glass panels must be checked using the following equations:

$$\Delta = \frac{200\text{lbs} \cdot h_e^3 [1+b/(h_e/12)]^{1/2}}{3 \cdot 10.4 \times 10^6 \text{psi} \cdot b \cdot t_g^3}$$

Δ = Deflection from 200 lb load at top corner of panel, inch

$$\Delta = \frac{50\text{lbs} \cdot h_e^3}{3 \cdot 10.4 \times 10^6 \text{psi} \cdot t_g^3}$$

$$3 \cdot 10.4 \times 10^6 \text{psi} \cdot t_g^3$$

Δ = Deflection from 50 plf load at top of panel, inch

h_e = effective glass cantilever height = $H_c + 0.5"$; height above base shoe + $\frac{1}{2}$ inch for Taper-Loc® installation, inch

b = glass panel width, inch

t_g = effective glass panel thickness for deflection based on Table 1, inch

When deflection exceeds the overall glass thickness or any glass panel is less than the minimum shown in Table 4 (glass is taller than indicated for the panel width), the adjacent glass panels must be connected together with a glass bracing clamp or a mall-front clamp installed no lower than 4 inches from the top edge of the glass or a U-channel or short cap rail segment with three-quarter inch bite and extending 2 inches minimum onto each panel and bonded to the glass with structural silicone or other adhesive approved for metal to glass. Corner panels must be similarly connected together. If end panel width is less than shown in Table 4, it must be similarly attached to a wall, post or similar structural member capable of supporting a 200 pound load. The connection between panels is not required when designed for wind load only and a three inch (75mm) minimum gap between panels is maintained.

Under the IRC or the 2015, 2012, 2009 and 2006 IBC, installation without a top rail is permitted for all assemblies designed in accordance with the provisions of this section. Under the 2018 and 2021 IBC, installation without a top rail is permitted when minimum 24 inch (609.4 mm) wide 13/16 inch nominal thickness laminated glass panels with non-pvb interlayers shown in Table 4 are installed with XL21LT Taper-Locs into either the L21S and 9BL21 base shoe; and differential deflection requirements and calculations outlined in this section must also be considered. For all other installations in accordance with the 2021 and 2018 IBC, all GRS™ Glass Balustrade Guard Systems shall be installed with a top rail or handrail in accordance with Section 2407.1.2 of the 2021 and 2018 IBC.

4.1.4.3 Installation with a Top Rail in Wind-Borne Debris Regions:

Installation with a top rail in wind-borne debris regions is permitted when used with laminated glass containing a SentryGlas® (non-PVB) interlayer as described in Section 3.1.3. The systems are rated in accordance with IBC Section 2407.1.4 for use in wind zones 1 through 4, in which missile levels A, B, C, or D are required in accordance with ASTM E1996 as modified by Section 1609.2.2 of the 2021 and 2018 IBC (Section 1609.1.2 of the 2015 IBC).

4.1.5 Taper-Loc® Dry Glazed Systems

4.1.5.1 Description: This is a dry glazing system where the laminated glass panel is clamped inside the base shoe by the Taper-Loc® shoe setting plate (L shaped piece on the back side) and the Taper-Loc® tapers (front side) as illustrated in Figure 8. The glass is locked in place by the compressive forces created by the Taper-Loc® tapers being compressed together by the installation tool. Use of the calibrated installation tool assures that the proper compressive forces are developed. The Taper-Loc® system is compatible with all base shoes in this report and the corresponding glass panel thickness.

4.1.5.2 Use: The appropriate Taper-Loc® set must be used for the specified base shoe and glass thickness and

installed in accordance to the manufacturer's installation instructions using the calibrated installation tool. Figure 8 shows the applicable dimensions.

4.1.6 Wet Glazing:

4.1.6.1 Description: Glass may be wet-glazed into any of the base shoes using a pourable grout that is compatible with treated aluminum and selected laminated glass. Any of the glass thicknesses in this report may be wet-glazed into any of the base shoes in this report. The allowable load must be the lesser of the allowable load on the glass from Table 1 or the base shoe for the anchorage method used from Table 2. (Figure 6).

4.1.6.2 Installation: Grout must be pourable, self-leveling and self-consolidating and must be verified as non-reactive with treated aluminum and the laminated glass interlayer (verifies with interlayer manufacturer / glass laminator). For exterior or other locations subjected to wetting the grout must be a gypsum-free hydraulic cement rated for exterior use, or epoxy based. Minimum grout compressive strength must exceed 1,500 psi (10.3 MPa) at 24 hours and 4,000 psi (27.6 MPa) at 28 days. The grout must be mixed, placed and cured in accordance with the grout manufacturer's instructions. Wet glazing grout must be continuous in the base shoe filling all voids and extend to the roll-in rubber glazing channel in the base shoe.

4.1.7 Handrails

4.1.7.1 General: Handrails must be installed as required per the applicable code.

4.1.7.2 Brackets: The handrails may be used with any combinations of brackets noted in Figure 10 such that the handrail clearance and projections are within the limits defined in the IBC Section 1014 (2012, 2009, and 2006 IBC Section 1012). The outer diameter of the handrail tubing attached to the HR3E and HR5E brackets shall not exceed 1.5 inches.

4.1.7.3 Installation: Handrails may be installed to glass panels using the through-glass mounting brackets shown in this report. The brackets must be installed in accordance with the manufacturer's instructions. The glass holes must comply with Section 4.1.2.1 of this report.

4.1.7.4 Support: The handrail must be installed so as to remain in place in the event of the failure of any one glass panel. This requires the use of a minimum of three glass panels or a combination of other handrail supports and glass panels totally three, minimum, similar to the top rail support illustrated in Figure 5. The handrail end condition must be checked to verify that the rail will remain in place in the event of failure of the end glass panel. End support must be designed when required for a code-compliant-installation.

4.1.7.5 Spacing: The bracket spacing must be within the limits shown in Table 5 with dimensions as defined in Figure 9.

4.1.7.6 Attachment: The handrail, when supported by the glass panel (balustrade), must be attached in accordance with the detail shown in Figure 11, and to the glass panel as shown in Figure 12. The stabilizing end cap shown in Figure 13 may be used to attach the handrail or top rail to a wall or perpendicular post face.

5.0 CONDITIONS OF USE

The CR Laurence Glass Rail System for Laminated Glass Rail System described in this report complies with, or is a suitable alternative to what is specified in, those codes listed in Section 1.0 of this report, subject to the following conditions:

- 5.1** The product is limited to installation where it is not subject to vehicle impacts.
- 5.2** The supporting structure must be designed and constructed to support the loads imposed by the guards in accordance with the applicable code. The anchorage to the frame must be as specified in this report or designed to provide the required strength for the specified balustrade height and imposed loads. Drawings and design details for the GRS™, using the information noted in this report, must be included on construction plans submitted to the code official for approval. The drawings and details must be prepared by a registered design professional where required by the statutes of the jurisdiction in which the project is to be constructed.
- 5.3** When use is in exterior locations, the wind loads must not exceed the values noted in Tables 1 and 2 of this report. For glass heights other than those noted in this report, the allowable wind loads must not exceed the value calculated by the following equation:

$$Wall_{wind} = M_{all_wind} * 12 / (0.55 * h^2)$$
 Where:
 - $Wall_{wind}$ = allowable wind load for the desired glass height, psf
 - M_{all_wind} = Lesser of: allowable glass moment from Table 1, lb.-in./ft. or base shoe allowable moment for the anchorage method from Table 2, lb.-in./ft.
 - h = glass panel height if glass strength controls or total height from bottom of base shoe if anchorage controls, feet.
- 5.4** The use of fully tempered laminated glass in the GRS™ system is permitted where there is a walking surface beneath in accordance with Section 2407.1 of the 2021, 2018, and 2015 IBC.
- 5.5** When installed where the base shoe anchors are exposed to moisture, the base shoe anchors must be of a material intended for the use and identified by the manufacturer as acceptable for exterior applications. When installed in a corrosive environment, such as exposure to saltwater or pool water, the anchors must be 316 stainless steel.
- 5.6** All metals in contact with aluminum must be either an alloy approved for direct aluminum contact, or isolated from the aluminum by an approved coating.
- 5.7** Use of the system as a grab bar is outside the scope of this report.
- 5.8** Glass sand-blasted or etched on surfaces 1 (outside face) or 4 (inside face) is outside the scope of this report.
- 5.9** A top rail or handrail must be installed in accordance with the manufacturer's (CRL's) instructions, and this report when required by the IBC or IRC, as applicable, except where it meets all requirements for installation without a top rail per Section 4.1.4.2 of this report.
- 5.10** All glass shall be fully tempered Type II laminated glass, with an interlayer complying with Section 3.1.3, fabricated and inspected in accordance with ASTM C1172; and the glass fabricator shall provide certification of compliance with ASTM C1172.
- 5.11** The GRS™ and Taper-Loc® components, except for the laminated glass panels, are supplied by C.R. Laurence Co., Inc., of Los Angeles, California.

6.0 EVIDENCE SUBMITTED

- 6.1 Data in accordance with the ICC-ES Acceptance Criteria for Glass Railing and Balustrade Systems (AC439) dated April 2019 (editorially revised August 2020), including ASTM E1996 impact tests
- 6.2 Manufacturer’s published installation instructions.
- 6.3 Engineering analysis reports:
 - 6.3.1 Taper-Loc® System Dry-Glaze Laminated Glass Rail System 9/16-inch Laminated Glass - L56S and 9BL56 Base Shoes, dated 13 July 2016.
 - 6.3.2 Taper-Loc® System Dry-Glaze Laminated Glass Rail System 11/16-inch Laminated Glass - L68S and 9BL68 Base Shoes, dated 13 July 2016.
 - 6.3.3 Taper-Loc® System Dry-Glaze Laminated Glass Rail System 13/16-inch Laminated Glass - L21S and 9BL21 Base Shoes, dated 13 July 2016.
 - 6.3.4 Taper-Loc® System Dry-Glaze Laminated Glass Rail System 11/16-inch Laminated Glass - L25S Base Shoe, dated 13 July 2016.
 - 6.3.5 GRS - Glass Rail System - Top Rails and Handrails, dated 11 Jan. 2017.

7.2 In addition, the GRS™ and Taper-Loc® guard system components described in this report are identified by a stamp on the packaging bearing the manufacturer’s name (C.R. Laurence Co., Inc., sometimes abbreviated as CRL); product description and/or part number; and the ICC-ES evaluation report number (ESR-3842).

The glass panels must be identified as specified in this report and the applicable code.

7.3 The report holder’s contact information is the following:

C.R. LAURENCE COMPANY, INC.
ARCHITECTURAL RAILING DIVISION
2503 EAST VERNON AVENUE
LOS ANGELES, CALIFORNIA 90058
(800) 421-6144 x7730
www.crlaurence.com
railings@crlaurence.com

7.0 IDENTIFICATION

7.1 The ICC-ES mark of conformity, electronic labeling, or the evaluation report number (ICC-0ES 3842) along with the name, registered trademark, or registered logo of the report holder [and/or listee] must be included in the product label.

TABLE 1A—NOMINAL 9/16” (13.52 mm) LAMINATED GLASS PANEL STRENGTH¹ (1/4” x .060” x 1/4”)

| GLASS PANEL WIDTH (in) | EFFECTIVE GLASS PANEL THICKNESS (in.) ² | | M _{all wind} (lb.-in./ft.) ³ | ALLOWABLE WIND PRESSURE (W _{all wind}) ⁴ , psf For glass panel height (H _c) ⁵ , in. | | | | | Live Load ⁷ 50 lbs/ft | |
|--|--|---------------------------|--|--|------|------|------|------|--|----------|
| | t _d for deflection. | t _e for stress | | 36 | 42 | 48 | 60 | 72 | Maximum Height (H _c) ^{5,6} inches based on: | |
| Non-PVB Interlayer Shear Modulus (G) must be ≥ 1,460 psi for T ≤ 122°F | | | | | | | | | Stress | 1” Defl. |
| 12 | 0.3121 | 0.3525 | 2386 | 40.2 | 29.5 | 22.6 | 14.5 | 10.0 | 29.3 | 26.2 |
| 24 | 0.3695 | 0.4105 | 3235 | 54.5 | 40.0 | 30.6 | 19.6 | 13.6 | 39.9 | 31.1 |
| 36 | 0.4116 | 0.4451 | 3804 | 64.0 | 47.0 | 36.0 | 23.1 | 16.0 | 47.0 | 34.7 |
| 41 | 0.4242 | 0.4543 | 3963 | * | 49.0 | 37.5 | 24.0 | 16.7 | 49.0 | 35.7 |
| 48 | 0.4383 | 0.4638 | 4130 | * | * | 39.1 | 25.0 | 17.4 | 51.1 | 37.0 |
| 60 | 0.4551 | 0.4744 | 4321 | * | * | * | 26.2 | 18.2 | 53.5 | 38.4 |
| 72 | 0.4660 | 0.4808 | 4438 | * | * | * | * | 18.7 | 55.0 | 39.3 |

For SI: 1 inch = 25.4 mm; 1 ft = 305 mm; 1 lb = 4.45 N

Footnotes to Tables 1A – 1D

1. *Allowable load is equivalent to the last value above.
2. The effective glass panel thicknesses must only be used where the glass panel height is greater than the tabulated glass panel width. The effective glass panel thicknesses may be used for interior conditions.
3. M_{all wind} is based on an allowable wind load stress of 9600 psi.
4. W_{all wind} (psf) = M_{all wind}*12/(0.55*H²) units: M_{all wind} (lb.-in./ft.); H (in.)
5. Glass height above top of base shoe H_c.
6. H_c based on the 50 plf uniform live load is also based on an allowable glass panel live load stress of 6000 psi.
7. Other loads listed in Section 4.1.1 must be considered.

TABLE 1B—NOMINAL 1¹/₁₆" (17.52mm) LAMINATED GLASS PANEL STRENGTH (5⁵/₁₆" x .060" x 5⁵/₁₆")

| GLASS PANEL WIDTH (in) | EFFECTIVE GLASS PANEL THICKNESS (in.) ² | | M _{all wind} (lb.-in./ft.) ³ | ALLOWABLE WIND PRESSURE (W _{all wind}) ⁴ , psf For glass panel height (H _c) ⁵ , in. | | | | | Live Load ⁷ 50 lbs/ft | |
|--|--|---------------------------|--|--|------|------|------|------|---|---------|
| | t _δ for deflection. | t _σ for stress | | 36 | 42 | 48 | 60 | 72 | Maximum Height (H _c) inches based on: | |
| Non-PVB Interlayer Shear Modulus (G) must be ≥ 1,460 psi for T ≤ 122°F | | | | | | | | | Stress | 1" Defl |
| 12 | 0.4578 | 0.5114 | 5021 | 84.5 | 62.1 | 47.6 | 30.4 | 21.1 | 62.3 | 38.6 |
| 24 | 0.5457 | 0.5850 | 6571 | 110.6 | 81.3 | 62.2 | 39.8 | 27.7 | 81.6 | 46.1 |
| 36 | 0.5883 | 0.6132 | 7219 | 121.5 | 89.3 | 68.4 | 43.8 | 30.4 | 89.7 | 49.8 |
| 41 | 0.5987 | 0.6194 | 7366 | * | 91.1 | 69.8 | 44.6 | 31.0 | 91.6 | 50.7 |
| 48 | 0.6092 | 0.6255 | 7512 | * | * | 71.1 | 45.5 | 31.6 | 93.4 | 51.6 |
| 60 | 0.6205 | 0.6317 | 7662 | * | * | * | 46.4 | 32.2 | 95.3 | 52.5 |
| 72 | 0.6271 | 0.6352 | 7747 | * | * | * | * | 32.6 | 96.3 | 53.1 |
| PVB Interlayer Shear Modulus (G) must be ≥ 70 psi for T ≤ 122°F | | | | | | | | | | |
| 12 | 0.3739 | 0.4202 | 3390 | 57.1 | 41.9 | 32.1 | 20.5 | 14.3 | 41.9 | 31.4 |
| 24 | 0.3901 | 0.4394 | 3707 | 62.4 | 45.9 | 35.1 | 22.5 | 15.6 | 45.8 | 32.8 |
| 36 | 0.4125 | 0.4674 | 4194 | 70.6 | 51.9 | 39.7 | 25.4 | 17.7 | 51.9 | 34.7 |
| 41 | 0.4227 | 0.4757 | 4345 | * | 53.7 | 41.1 | 26.3 | 18.3 | 53.8 | 35.6 |
| 48 | 0.7372 | 0.4910 | 4629 | * | * | 43.8 | 28.1 | 19.5 | 57.4 | 62.5 |
| 60 | 0.4616 | 0.5151 | 5094 | * | * | * | 30.9 | 21.4 | 63.2 | 38.9 |
| 72 | 0.4841 | 0.5358 | 5512 | * | * | * | * | 23.2 | 68.4 | 40.9 |

See footnotes under Table 1A

TABLE 1C—NOMINAL 13/16" (21.52mm) LAMINATED GLASS PANEL STRENGTH (3/8" x .060" x 3/8")

| GLASS PANEL WIDTH (in) | EFFECTIVE GLASS PANEL THICKNESS (in.) ² | | M _{all wind} (lb.-in./ft.) ³ | ALLOWABLE WIND PRESSURE (W _{all wind}) ⁴ , psf For glass panel height (H _c) ⁵ , in. | | | | | Live Load ⁷ 50 lbs/ft | |
|--|--|---------------------------|--|--|-------|-------|------|------|---|---------|
| | t _d for deflection. | t _s for stress | | 36 | 42 | 48 | 60 | 72 | Maximum Height (H _c) inches based on: | |
| Non-PVB Interlayer Shear Modulus (G) must be ≥ 1,460 psi for T ≤ 122°F | | | | | | | | | Stress | 1" Defl |
| 12 | 0.5384 | 0.6023 | 6965 | 117.3 | 86.1 | 66.0 | 42.2 | 29.3 | 86.6 | 45.5 |
| 24 | 0.6399 | 0.6901 | 9144 | 153.9 | 113.1 | 86.6 | 55.4 | 38.5 | 113.8 | 54.2 |
| 36 | 0.6938 | 0.7272 | 10153 | 170.9 | 125.6 | 96.1 | 61.5 | 42.7 | 126.4 | 58.8 |
| 41 | 0.7075 | 0.7356 | 10389 | * | 128.5 | 98.4 | 63.0 | 43.7 | 129.4 | 60.0 |
| 48 | 0.7216 | 0.7440 | 10628 | * | * | 100.6 | 64.4 | 44.7 | 132.3 | 61.2 |
| 60 | 0.7370 | 0.7527 | 10878 | * | * | * | 65.9 | 45.8 | 135.5 | 62.5 |
| 72 | 0.7462 | 0.7577 | 11023 | * | * | * | * | 46.4 | 137.3 | 63.3 |
| PVB or Non-PVB Interlayer Shear Modulus (G) must be ≥ 70 psi for T ≤ 122°F | | | | | | | | | | |
| 12 | 0.4529 | 0.5088 | 4970 | 83.7 | 61.5 | 47.1 | 30.1 | 20.9 | 61.6 | 38.2 |
| 24 | 0.4686 | 0.5272 | 5336 | 89.8 | 66.0 | 50.5 | 32.3 | 22.5 | 66.2 | 39.5 |
| 36 | 0.4909 | 0.5525 | 5861 | 98.7 | 72.5 | 55.5 | 35.5 | 24.7 | 72.8 | 41.4 |
| 41 | 0.5014 | 0.5639 | 6105 | * | 75.5 | 57.8 | 37.0 | 25.7 | 75.8 | 42.3 |
| 48 | 0.5165 | 0.5800 | 6459 | * | * | 61.2 | 39.1 | 27.2 | 80.2 | 43.6 |
| 60 | 0.5426 | 0.6064 | 7060 | * | * | * | 42.8 | 29.7 | 87.8 | 45.9 |
| 72 | 0.5676 | 0.6300 | 7620 | * | * | * | * | 32.1 | 94.8 | 48.0 |

See footnotes under Table 1A

TABLE 1D—NOMINAL 1 1/16" (25.52) LAMINATED GLASS PANEL STRENGTH (1/2" x .060" x 1/2")

| GLASS PANEL WIDTH (in) | EFFECTIVE GLASS PANEL THICKNESS (in.) ² | | M _{all wind} (lb.-in./ft.) ³ | ALLOWABLE WIND PRESSURE (W _{all wind}) ⁴ , psf For glass panel height (H _c) ⁵ , in. | | | | | Live Load ⁷ 50 lbs/ft | |
|--|--|---------------------------|--|--|-------|-------|-------|------|---|---------|
| | t _d for deflection. | t _s for stress | | 36 | 42 | 48 | 60 | 72 | Maximum Height (H _c) inches based on: | |
| Non-PVB Interlayer Shear Modulus (G) must be ≥ 1,460 psi for T ≤ 122°F | | | | | | | | | Stress | 1" Defl |
| 12 | 0.6837 | 0.7957 | 12156 | 204.7 | 150.4 | 115.1 | 73.7 | 51.2 | 151.5 | 57.9 |
| 24 | 0.8056 | 0.8758 | 14727 | 247.9 | 182.2 | 139.5 | 89.3 | 62.0 | 183.6 | 68.3 |
| 36 | 0.8795 | 0.9295 | 16588 | 279.3 | 205.2 | 157.1 | 100.5 | 69.8 | 206.9 | 74.7 |
| 41 | 0.8995 | 0.9425 | 17055 | * | 211.0 | 161.5 | 103.4 | 71.8 | 212.7 | 76.4 |
| 48 | 0.9206 | 0.955 | 17511 | * | * | 165.8 | 106.1 | 73.7 | 218.4 | 78.2 |
| 60 | 0.9444 | 0.9695 | 18047 | * | * | * | 109.4 | 76.0 | 225.1 | 80.2 |
| 72 | 0.9590 | 0.9776 | 18349 | * | * | * | * | 77.2 | 228.9 | 81.4 |
| PVB or Non-PVB Interlayer Shear Modulus (G) must be ≥ 70 psi for T ≤ 122°F | | | | | | | | | | |
| 12 | 0.5962 | 0.6695 | 8606 | 144.9 | 106.4 | 81.5 | 52.2 | 36.2 | 107.1 | 50.4 |
| 24 | 0.6112 | 0.6870 | 9062 | 152.6 | 112.1 | 85.8 | 54.9 | 38.1 | 112.8 | 51.7 |
| 36 | 0.6334 | 0.7121 | 9736 | 163.9 | 120.4 | 92.2 | 59.0 | 41.0 | 121.2 | 53.6 |
| 41 | 0.6441 | 0.7239 | 10061 | * | 124.4 | 95.3 | 61.0 | 42.3 | 125.3 | 54.5 |
| 48 | 0.6599 | 0.7410 | 10542 | * | * | 99.8 | 63.9 | 44.4 | 131.3 | 55.9 |
| 60 | 0.6883 | 0.7704 | 11396 | * | * | * | 69.1 | 48.0 | 141.9 | 58.3 |
| 72 | 0.7166 | 0.7982 | 12233 | * | * | * | * | 51.5 | 152.4 | 60.7 |

See footnotes under Table 1A

TABLE 2—BASE SHOE ANCHORAGE STRENGTH

| Substrate – Anchor/Fastener Spacing | Allowable Moment in-lbs/ft | Allowable wind load, psf ¹ | | | | | | | Live Load ⁵ 50 lbs/ft |
|--|----------------------------|--|-------|-------|-------|-------|-------|-------|-------------------------------------|
| | | Overall Guard height from bottom of base shoe top of top rail (H _g), in. | | | | | | | Max. guard ht (H _g) in. |
| | | 36 | 39 | 42 | 45 | 48 | 54 | 60 | |
| BASE SHOE: L56S & 9BL56 - Surface Mounted | | | | | | | | | |
| Steel 12" o.c. | 5146.0 | 86.6 | 73.8 | 63.6 | 55.4 | 48.7 | 38.5 | 31.2 | 102.9 |
| Steel 6" o.c. L56S | 10255.0 | 172.6 | 147.1 | 126.8 | 110.5 | 97.1 | 76.7 | 62.2 | 205.1 |
| Steel 6" o.c. 9BL56 | 9937.0 | 167.3 | 142.5 | 122.9 | 107.1 | 94.1 | 74.4 | 60.2 | 198.7 |
| Concrete ^{1,2} 12" o.c. | 2254.0 | 37.9 | 32.3 | 27.9 | 24.3 | 21.3 | 16.9 | 13.7 | 45.1 |
| Concrete ^{1,2} 6" o.c. | 4442.0 | 74.8 | 63.7 | 54.9 | 47.9 | 42.1 | 33.2 | 26.9 | 88.8 |
| Wood 12" o.c. ³ | 2651.0 | 44.6 | 38.0 | 32.8 | 28.6 | 25.1 | 19.8 | 16.1 | 53.0 |
| Wood 6" o.c. ³ | 4854.0 | 81.7 | 69.6 | 60.0 | 52.3 | 46.0 | 36.3 | 29.4 | 97.1 |
| BASE SHOE: L56S & 9BL56 - Fascia Mounted | | | | | | | | | |
| Steel 12" o.c. | 8064.0 | 135.8 | 115.7 | 99.7 | 86.9 | 76.4 | 60.3 | 48.9 | 161.3 |
| Steel 6" o.c. L56S | 16092.0 | 270.9 | 230.8 | 199.0 | 173.4 | 152.4 | 120.4 | 97.5 | 321.8 |
| Steel 6" o.c. 9BL56 | 9937.0 | 167.3 | 142.5 | 122.9 | 107.1 | 94.1 | 74.4 | 60.2 | 198.7 |
| Concrete ^{1,2} 12" o.c. | 3547.0 | 59.7 | 50.9 | 43.9 | 38.2 | 33.6 | 26.5 | 21.5 | 70.9 |
| Concrete ^{1,2} 6" o.c. | 7002.0 | 117.9 | 100.4 | 86.6 | 75.4 | 66.3 | 52.4 | 42.4 | 140.0 |
| Wood 12" o.c. | 4250.0 | 71.5 | 61.0 | 52.6 | 45.8 | 40.2 | 31.8 | 25.8 | 85.0 |
| Wood 6" o.c. | 8104.0 | 136.4 | 116.2 | 100.2 | 87.3 | 76.7 | 60.6 | 49.1 | 162.1 |
| BASE SHOE: L68S & 9BL68 - Surface Mounted | | | | | | | | | |
| Steel 11-13/16" o.c. | 8038.0 | 135.3 | 115.3 | 99.4 | 86.6 | 76.1 | 60.1 | 48.7 | 160.8 |
| Steel 5-7/8" o.c. | 15995.0 | 269.3 | 229.4 | 197.8 | 172.3 | 151.5 | 119.7 | 96.9 | 319.9 |
| Concrete ^{1,2} 12M HSL 11-13/16" o.c. | 3788.0 | 63.8 | 54.3 | 46.9 | 40.8 | 35.9 | 28.3 | 23.0 | 75.8 |
| Concrete ^{1,2} 1/2" HUS-EZ 11-13/16" | 2762.0 | 46.5 | 39.6 | 34.2 | 29.8 | 26.2 | 20.7 | 16.7 | 55.2 |
| Concrete ^{1,2} 1/2" HUS-EZ 5-7/8" o.c. | 3365.0 | 56.6 | 48.3 | 41.6 | 36.3 | 31.9 | 25.2 | 20.4 | 67.3 |
| Wood 11-13/16" o.c. ³ | 2859.0 | 48.1 | 41.0 | 35.4 | 30.8 | 27.1 | 21.4 | 17.3 | 57.2 |
| Wood 5-7/8" o.c. ³ | 5207.0 | 87.7 | 74.7 | 64.4 | 56.1 | 49.3 | 39.0 | 31.6 | 104.1 |
| BASE SHOE: L68S & 9BL68 - Fascia Mounted | | | | | | | | | |
| Steel 11-13/16" o.c. | 9861.0 | 166.0 | 141.5 | 122.0 | 106.2 | 93.4 | 73.8 | 59.8 | 197.2 |
| Steel 5-7/8" o.c. | 19668.0 | 331.1 | 282.1 | 243.3 | 211.9 | 186.3 | 147.2 | 119.2 | 393.4 |
| Concrete ^{1,2} 12M HSL 11-13/16" o.c. | 4781.0 | 80.5 | 68.6 | 59.1 | 51.5 | 45.3 | 35.8 | 29.0 | 95.6 |
| Concrete ^{1,2} 1/2" HUS-EZ 11-13/16" | 3074.0 | 51.8 | 44.1 | 38.0 | 33.1 | 29.1 | 23.0 | 18.6 | 61.5 |
| Concrete ^{1,2} 1/2" HUS-EZ 5-7/8" o.c. | 3744.0 | 63.0 | 53.7 | 46.3 | 40.3 | 35.5 | 28.0 | 22.7 | 74.9 |
| Wood 11-13/16" o.c. ⁴ | 4249.0 | 71.5 | 61.0 | 52.6 | 45.8 | 40.2 | 31.8 | 25.8 | 85.0 |
| Wood 5-7/8" o.c. ⁴ | 8104.0 | 136.4 | 116.2 | 100.2 | 87.3 | 76.7 | 60.6 | 49.1 | 162.1 |

For SI: 1 inch = 25.4 mm; 1 ft = 305 mm; 1 lb = 4.45 N

¹Linear interpolation between guard heights, anchor spacing and edge distances is permitted.

²Tabulated values are based on substrates specification and anchors/fasteners specified in Section 4.1.3, unless otherwise noted. Adjustments may be made in accordance with Section 4.1.3 as applicable.

³Tabulated values based on dry applications only (wood moisture content maintained < 19%).

⁴Tabulated values based on wet applications (wood moisture content is ≥ 19%). Tabulated values may conservatively be used for dry applications.

⁵Other loads listed in Section 4.1.1 must be considered.

TABLE 2—BASE SHOE ANCHORAGE STRENGTH (Continued)

| BASE SHOE: L21S & 9BL21 | | Allowable wind load, psf ¹ | | | | | | | Live Load ⁵ 50 lbs/ft |
|--|----------------------------|--|-------|-------|-------|-------|-------|-------|-------------------------------------|
| Substrate – Anchor/ Fastener Spacing | Allowable Moment in-lbs/ft | Overall Guard height from bottom of base shoe top of top rail (H _g), in. | | | | | | | Max. guard ht (H _g) in. |
| | | 36 | 39 | 42 | 45 | 48 | 54 | 60 | |
| BASE SHOE: L21S & 9BL21 - Surface Mounted | | | | | | | | | |
| Steel 11-13/16" o.c. | 8455.0 | 142.3 | 121.3 | 104.6 | 91.1 | 80.1 | 63.3 | 51.2 | 169.1 |
| Steel 5-7/8" o.c. | 16828.0 | 283.3 | 241.4 | 208.1 | 181.3 | 159.4 | 125.9 | 102.0 | 336.6 |
| Concrete ^{1,2} 12M HSL 11-13/16" o.c. | 4000.0 | 67.3 | 57.4 | 49.5 | 43.1 | 37.9 | 29.9 | 24.2 | 80.0 |
| Concrete ^{1,2} 1/2" HUS-EZ 11-13/16" o.c. | 2925.0 | 49.2 | 42.0 | 36.2 | 31.5 | 27.7 | 21.9 | 17.7 | 58.5 |
| Concrete ^{1,2} 1/2" HUS-EZ 5-7/8" o.c. | 3547.0 | 59.7 | 50.9 | 43.9 | 38.2 | 33.6 | 26.5 | 21.5 | 70.9 |
| Wood 11-13/16" o.c. ³ | 2971.0 | 50.0 | 42.6 | 36.7 | 32.0 | 28.1 | 22.2 | 18.0 | 59.4 |
| Wood 5-7/8" o.c. ³ | 5610.0 | 94.4 | 80.5 | 69.4 | 60.4 | 53.1 | 42.0 | 34.0 | 112.2 |
| BASE SHOE: L21S & 9BL21 - Fascia Mounted | | | | | | | | | |
| Steel 11-13/16" o.c. | 9861.0 | 166.0 | 141.5 | 122.0 | 106.2 | 93.4 | 73.8 | 59.8 | 197.2 |
| Steel 5-7/8" o.c. | 19668.0 | 331.1 | 282.1 | 243.3 | 211.9 | 186.3 | 147.2 | 119.2 | 393.4 |
| Concrete ^{1,2} 12M HSL 11-13/16" o.c. | 4781.0 | 80.5 | 68.6 | 59.1 | 51.5 | 45.3 | 35.8 | 29.0 | 95.6 |
| Concrete ^{1,2} 1/2" HUS-EZ 11-13/16" o.c. | 3074.0 | 51.8 | 44.1 | 38.0 | 33.1 | 29.1 | 23.0 | 18.6 | 61.5 |
| Concrete ^{1,2} 1/2" HUS-EZ 5-7/8" o.c. | 3934.0 | 66.2 | 56.4 | 48.7 | 42.4 | 37.3 | 29.4 | 23.8 | 78.7 |
| Wood 11-13/16" o.c. ⁴ | 4235.0 | 71.3 | 60.7 | 52.4 | 45.6 | 40.1 | 31.7 | 25.7 | 84.7 |
| Wood 5-7/8" o.c. ⁴ | 8052.0 | 135.6 | 115.5 | 99.6 | 86.8 | 76.3 | 60.2 | 48.8 | 161.0 |
| BASE SHOE: L25S - Surface Mounted | | | | | | | | | |
| Steel 11-13/16" o.c. | 8954.0 | 150.7 | 128.4 | 110.7 | 96.5 | 84.8 | 67.0 | 54.3 | 179.1 |
| Steel 5-7/8" o.c. | 17827.0 | 300.1 | 255.7 | 220.5 | 192.1 | 168.8 | 133.4 | 108.0 | 356.5 |
| Concrete ^{1,2} 12M HSL 11-13/16" o.c. | 4250.0 | 71.5 | 61.0 | 52.6 | 45.8 | 40.2 | 31.8 | 25.8 | 85.0 |
| Concrete ^{1,2} 1/2" HUS-EZ 11-13/16" o.c. | 3105.0 | 52.3 | 44.5 | 38.4 | 33.5 | 29.4 | 23.2 | 18.8 | 62.1 |
| Concrete ^{1,2} 1/2" HUS-EZ 5-7/8" o.c. | 3773.0 | 63.5 | 54.1 | 46.7 | 40.7 | 35.7 | 28.2 | 22.9 | 75.5 |
| Wood 11-13/16" o.c. ³ | 3209.0 | 54.0 | 46.0 | 39.7 | 34.6 | 30.4 | 24.0 | 19.4 | 64.2 |
| Wood 5-7/8" o.c. ³ | 6318.0 | 106.4 | 90.6 | 78.1 | 68.1 | 59.8 | 47.3 | 38.3 | 126.4 |
| BASE SHOE: L25S - Fascia Mounted | | | | | | | | | |
| Steel 11-13/16" o.c. | 9861.0 | 166.0 | 141.5 | 122.0 | 106.2 | 93.4 | 73.8 | 59.8 | 197.2 |
| Steel 5-7/8" o.c. | 19668.0 | 331.1 | 282.1 | 243.3 | 211.9 | 186.3 | 147.2 | 119.2 | 393.4 |
| Concrete ^{1,2} 12M HSL 11-13/16" o.c. | 4781.0 | 80.5 | 68.6 | 59.1 | 51.5 | 45.3 | 35.8 | 29.0 | 95.6 |
| Concrete ^{1,2} 1/2" HUS-EZ 11-13/16" o.c. | 3074.0 | 51.8 | 44.1 | 38.0 | 33.1 | 29.1 | 23.0 | 18.6 | 61.5 |
| Concrete ^{2,3,4} 1/2" HUS-EZ 5-7/8" o.c. | 3934.0 | 66.2 | 56.4 | 48.7 | 42.4 | 37.3 | 29.4 | 23.8 | 78.7 |
| Wood 11-13/16" o.c. ⁴ | 4235.0 | 71.3 | 60.7 | 52.4 | 45.6 | 40.1 | 31.7 | 25.7 | 84.7 |
| Wood 5-7/8" o.c. ⁴ | 8052.0 | 135.6 | 115.5 | 99.6 | 86.8 | 76.3 | 60.2 | 48.8 | 161.0 |

TABLE 3—MAXIMUM GLASS PANEL WIDTH

| TOP RAIL PROFILE | MATERIAL | FOR USE WITH LAMINATED GLASS THICKNESS (inch) | Max Glass Panel Width (inches) | Max End lite width (inches) ² |
|------------------|-----------|---|--------------------------------|--|
| GR15 | Stainless | 9/16 | 55 | 17 |
| GR15 | Brass | 9/16 | 43 | 9 |
| GRS/GRSC15 | Stainless | 9/16 | 73 | 15 |
| GR16 | Stainless | 9/16 – 11/16 | 72 | 21 |
| GR19 | Aluminum | 9/16 – 11/16 | 84 | 21 |
| GR20 | Stainless | 9/16 – 11/16 | 96 | 33 |
| GR20 | Brass | 9/16 – 11/16 | 96 | 20 |
| GRS/GRSC20 | Stainless | 9/16 – 11/16 | 96 | 30 |
| GR25 | Stainless | 9/16 – 11/16 | 96 | 58 |
| GR25 | Brass | 9/16 – 11/16 | 96 | 32 |
| GR25 | Aluminum | 9/16 – 11/16 | 96 | 40 |
| GRS25 | Stainless | 9/16 – 11/16 | 96 | 30 |
| GR30 | Stainless | 9/16 – 11/16 | 96 | 72 |
| GR30 | Brass | 9/16 – 11/16 | 96 | 50 |
| GR30 | Aluminum | 9/16 – 11/16 | 96 | 63 |
| GR35 | Stainless | 9/16 – 11/16 | 96 | 72 |
| GR35 | Brass | 9/16 – 11/16 | 96 | 56 |
| GR35 | Aluminum | 9/16 – 11/16 | 96 | 85 |
| GR40 | Stainless | 9/16 – 11/16 | 96 | 72 |
| GR40 | Brass | 9/16 – 11/16 | 96 | 42 |
| GR207 | Stainless | 9/16 – 13/16 | 96 | 34 |

| TOP RAIL PROFILE | MATERIAL | FOR USE WITH LAMINATED GLASS THICKNESS (inch) | Max Glass Panel Width (inches) | Max. End lite width (inches) ² |
|------------------|-----------|---|--------------------------------|---|
| GR207 | Brass | 9/16 – 13/16 | 96 | 17 |
| GR257 | Stainless | 9/16 – 13/16 | 96 | 56 |
| GR257 | Brass | 9/16 – 13/16 | 96 | 29 |
| GR307 | Stainless | 9/16 – 13/16 | 98 | 69 |
| GR307 | Brass | 9/16 – 13/16 | 96 | 37 |
| GR307M | Aluminum | 9/16 – 13/16 | 96 | 64 |
| GROV4 | Aluminum | 9/16 – 11/16 | 96 | 60 |
| GRLC10 | Stainless | 9/16 – 11/16 | 83 | 24 |
| GRL10 | Stainless | 9/16 – 11/16 | 81 | 24 |
| SRF15 | Stainless | 9/16 – 13/16 | 65 | 18 |
| SRF20 | Stainless | 9/16 – 1 1/16 | 96 | 25 |
| GRRF15 | Stainless | 9/16 – 13/16 | 48 | 12 |
| GRRF20 | Stainless | 9/16 – 1 1/16 | 56.75 | 21.75 |
| BLUMCRAFT 324 | Aluminum | 9/16 – 11/16 | 96 | 24 |
| L10 | Stainless | 9/16 – 1 1/16 | 81 | 24 |
| LR20 | Stainless | 9/16 – 1 1/16 | 96 | 43 |
| LR25 | Stainless | 9/16 – 1 1/16 | 96 | 80 |

For SI: 1 inch = 25.4 mm

1. Based on the capacity of the top rail considering the worst case between a 50 plf uniform load and a 200 lb. concentrated load.
2. Maximum end lite width applies if glass cantilever height H_c exceeds the limits in Table 4.

TABLE 4—MAXIMUM GLASS PANEL HEIGHT FOR INSTALLATION WITHOUT TOP RAIL (2 Glass plies of equal thickness and .060" non-PVB interlayer)

| GLASS PANEL WIDTH, inches | MAX PANEL HEIGHT, inches | | | |
|---------------------------|--------------------------|--------------|--------------|--------------|
| | 9/16" | 11/16" | 13/16" | 1-1/16" |
| | G ≥ 460 psi | G ≥ 1640 psi | G ≥ 1640 psi | G ≥ 1640 psi |
| 12 | 5.60 | 11.80 | 16.30 | 26.40 |
| 24 | 15.20 | 30.80 | 42.50 | 54.00 |
| 36 | 26.70 | 43.30 | 51.30 | 65.60 |
| 41 | 31.70 | 45.60 | 54.20 | 69.40 |
| 48 | 36.30 | 46.90 | 57.80 | 72.60 |
| 60 | 38.80 | 47.90 | 63.00 | 82.80 |
| 72 | 38.80 | 48.40 | 64.80 | 83.50 |

For SI: 1 inch = 25.4 mm; 1 lb = 4.45 N

1. Linear interpolation for other panel widths is permitted.
2. Based on the worse case between a 50 plf uniform load and a 200 lb. concentrated load applied at max panel height.
3. Deflection must be determined per Section 4.1.4.2.

TABLE 5—HANDRAIL BRACKET SPACING¹

| HANDRAIL | MATERIAL ² | L2 inches | Le inches |
|-----------------------------|-------------------------------------|-----------|-----------|
| 1-1/4-inch Sched 40 | Galvanized Steel or Stainless Steel | 96 | 24 |
| 1-1/4-inch Sched 40 | Aluminum | 84 | 21 |
| 1-1/2-inch Sched 40 | Galvanized Steel or Stainless Steel | 115 | 34 |
| 1-1/2-inch Sched 40 | Aluminum | 96 | 29 |
| 1-1/2-inch x 1/8-inch Tube | Stainless Steel | 102 | 27 |
| 1-1/2-inch x 1/8-inch Tube | Aluminum | 62 | 15 |
| 1-1/2-inch x 0.05-inch Tube | Stainless Steel | 50 | 12 |
| 2-inches x 0.05-inch Tube | Stainless Steel | 92 | 22 |

For SI: 1 inch = 25.4 mm

- ¹See Figure 9
- ²See Section 3.1.2 for material specifications
- ³Based on the worse case between a 50 plf uniform load and a 200 lb. concentrated load.

FIGURES:

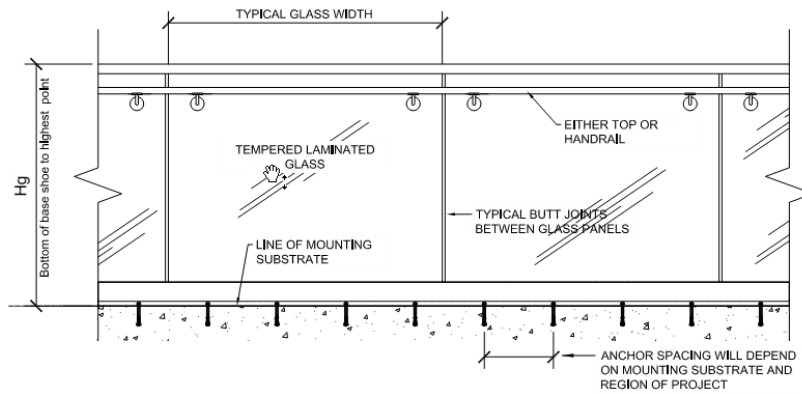

FIGURE 1—TYPICAL GLASS RAILING ELEVATION FOR SURFACE MOUNTED GUARD RAILS IN CONCRETE

| LAMINATED GLASS |  |  | TAPER-LOC |
|----------------------|---|---|------------------------------|
| 9/16" (13.52mm) | L56S (4 ³ / ₄ H x 2 ⁷ / ₈ W) | 9BL56 (4 ³ / ₄ H x 2 ⁷ / ₈ W) | LTL96X1 |
| 11/16" (17.52mm) | L68S (4 ³ / ₄ H x 3 ¹ / ₁₆ W) | 9BL68 (4 ³ / ₄ H x 3 ¹ / ₁₆ W) | LTL96X1 TLXATSL XA17LT |
| 13/16" (21.52mm) | L21S (4 ³ / ₄ H x 3 ³ / ₁₆ W) | 9BL21 (4 ³ / ₄ H x 3 ³ / ₁₆ W) | LTL10X1 TLXATSL XL21LT |
| 1-1/16" (25.52mm) | L25S (4 ³ / ₄ H x 3 ³ / ₈ W) | - | LTL10X |

FIGURE 2—BASE SHOES



Notes for Figure 3

- 1/4"x6" 6063 T5 aluminum bars or bent plate
- Fillet weld corner slot 3" @ 12" o.c.
- Base shoe weld 3/16" fillet 3" @ 12" o.c.
- The fasteners used to attach the bracket to the wood substrate must be 8 ea. No.14x3-inch (76 mm) stainless steel wood screws.

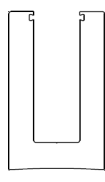
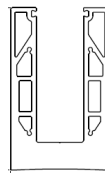
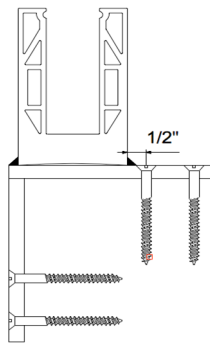
FIGURE 3—ALUMINUM BRACKET SURFACE MOUNT
DETAIL WOOD SUBSTRATE

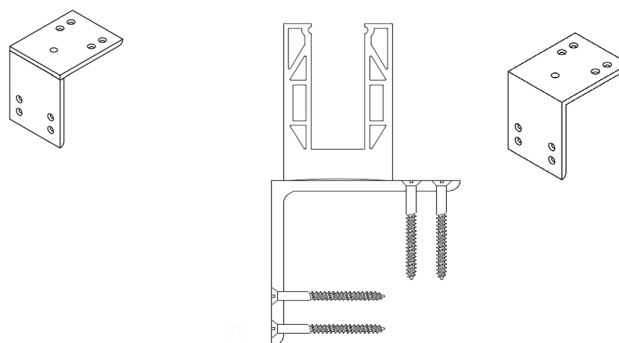

Notes for Figure 4

- L5x5x5/16x4" complying with ASTM A36 spaced at 12" o.c.
- CRL BSWMA1, dated 10/26/2015 for L56S/9BL56
- CRL BSWMA2, dated 3/9/2017 for other listed base shoes.
- Not Shown: The based shoe is connected to the steel angle with 1/2-inch diameter by 3/4-inch long (12.7 mm by 19.1 mm) ASTM F-837 Alloy Group 1 (any condition), stainless steel socket head cap screws into tapped holes spaced 12" o.c. .
- The fasteners used to attach the bracket to the wood substrate must be 8 ea. No.14x3-inch (76 mm) stainless steel wood screws

FIGURE 4—STEEL BRACKET SURFACE MOUNT
DETAIL WOOD SUBSTRATE

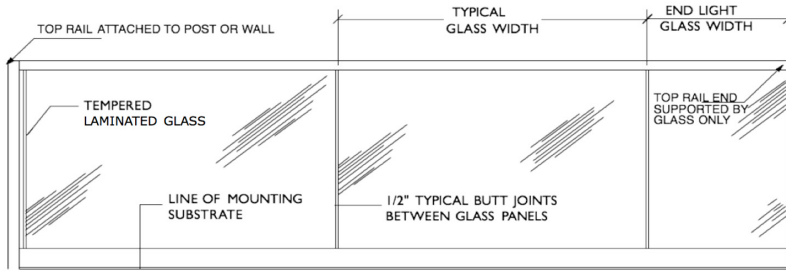

FIGURE 5—TOP RAIL SUPPORT OPTIONS

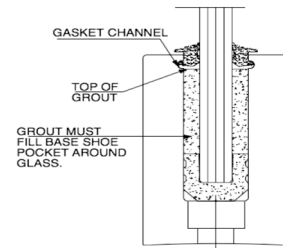
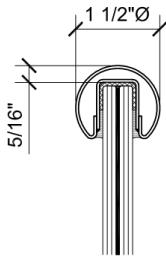
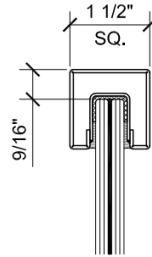

FIGURE 6—WET GLAZING



GR15
Stainless or Brass
9/16" Laminated Glass



GRS/GRSC15
Stainless
9/16" Laminated Glass

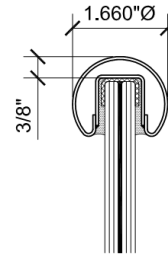

GR16
Stainless
9/16" – 11/16" Laminated Glass

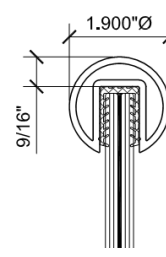

GR19
Aluminum
9/16" – 11/16" Laminated Glass

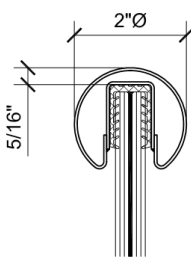

GR20
Stainless or Brass
9/16" – 11/16" Laminated Glass

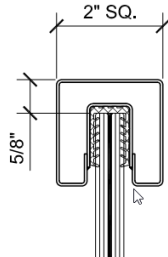

GRS20
Stainless
9/16" – 11/16" Laminated Glass

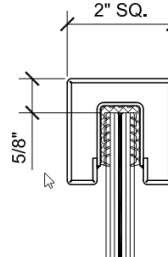

GRSC20
Stainless
9/16" – 11/16" Laminated Glass

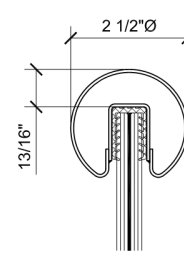

GR25
Stainless, Brass
9/16" – 11/16" Laminated Glass

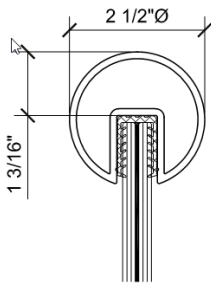

GR25
Aluminum
9/16" – 11/16" Laminated Glass

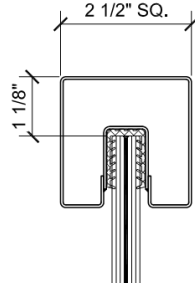

GRS25
Stainless
9/16" – 11/16" Laminated Glass

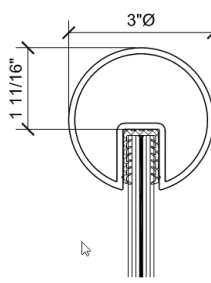

GR30
Aluminum
9/16" – 11/16" Laminated Glass

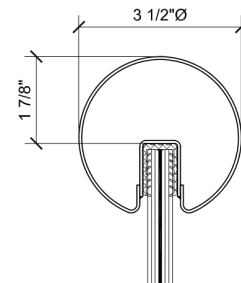

GR35
Stainless, Brass
9/16" – 11/16" Laminated Glass

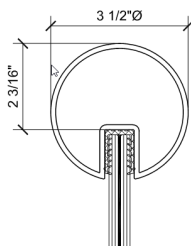

GR35
Aluminum
9/16" – 11/16" Laminated Glass

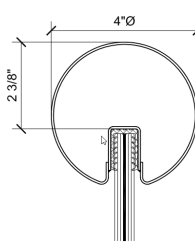

GR40
Stainless, Brass
9/16" – 11/16" Laminated Glass

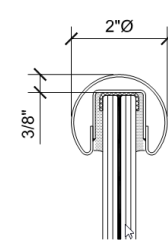

GR207
Stainless, Brass
9/16" – 13/16" Laminated Glass

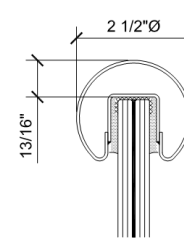

GR257
Stainless, Brass
9/16" – 13/16" Laminated Glass

FIGURE 7—CAPRAILS (CRL / BLUMCRAFT)

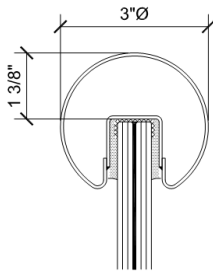

GR307
Stainless, Brass
9/16" – 13/16" Laminated Glass

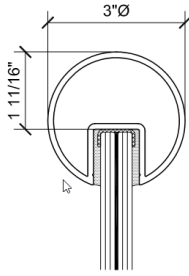

GR307
Aluminum
9/16" – 13/16" Laminated Glass

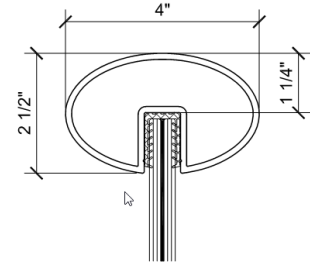

GROV4
Aluminum
9/16" – 11/16" Laminated Glass

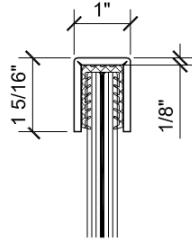

GRLC10
Stainless
9/16" – 11/16" Laminated Glass

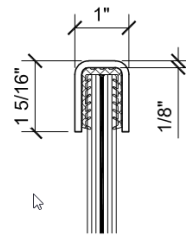

GRL10
Stainless
9/16" – 11/16" Laminated Glass

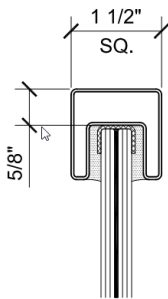

SRF15
Stainless
9/16" – 13/16" Laminated Glass

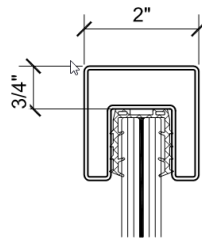

SRF20
Stainless
9/16" – 1-1/16" Laminated Glass

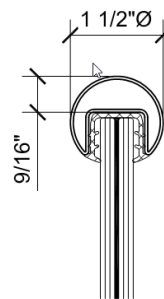

GRRF15
Stainless
9/16" – 13/16" Laminated Glass

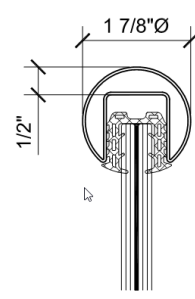

GRRF20
Stainless
9/16" – 1-1/16" Laminated Glass

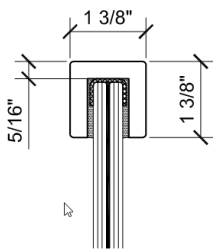

324
Aluminum
9/16" – 11/16" Laminated Glass

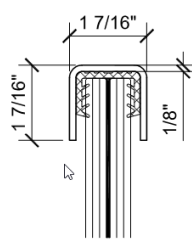

L10
Stainless
9/16" – 1-1/16" Laminated Glass

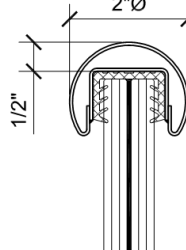

LR20
Stainless
9/16" – 1-1/16" Laminated Glass

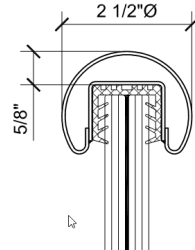

LR25
Stainless
9/16" – 1-1/16" Laminated Glass

FIGURE 7—CAPRAILS (CRL / BLUMCRAFT) (Continued)

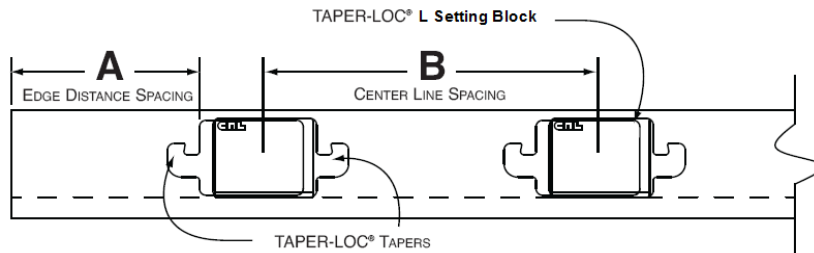

TYPICAL BASE SHOE ELEVATION DETAIL WITH TAPER-LOC® LOCATIONS

Edge Distance: 2-inches $\leq A \leq 8\frac{5}{8}$ -inches; 51mm $\leq A \leq 219$ mm for Glass thickness $\geq 5/8$ "
 Center to center spacing: 7-inches $\leq B \leq 14$ -inches; 178mm $\leq B \leq 356$ mm for Glass thickness $\geq 5/8$ "
 Edge Distance: 2-inches $\leq A \leq 5$ -inches; 51mm $\leq A \leq 127$ mm for Glass thickness $< 5/8$ "
 Center to center spacing: 6 2/3 inches $\leq B \leq 10$ -inches; 169mm $\leq B \leq 254$ mm for Glass thickness $< 5/8$ "

| Minimum number of Taper-Loc® sets | Glass Panel Widths Glass Panel Thickness = 9/16" | Glass Panel Widths (L) Glass Panel Thickness > 9/16" |
|-----------------------------------|---|---|
| 1 set | 6-in to < 10-in (127 to 254 mm) | ≤ 14 -inches (≤ 356 mm) |
| 2 sets | 10-in to < 16-in (254 to 406 mm) | 14-in < L ≤ 28 -in (356mm < L ≤ 712 mm) |
| 3 sets | 16-in to < 24-in (406 to 610 mm) | 28-in < L ≤ 42 -in (712mm < L ≤ 1067 mm) |
| 4 sets | 24-in to < 32-in (610 to 813 mm) | 42-in < L ≤ 56 -in (1067mm < L ≤ 1422 mm) |
| 5 sets | 32-in to < 40-in (813 to 1,016 mm) | 56-in < L ≤ 70 -in (1422mm < L ≤ 1788 mm) |
| 6 sets | 40-in to < 48-in (1,016 to 1,219 mm) | 70-in < L ≤ 84 -in (1788mm < L ≤ 2134 mm) |
| 7 sets | 48-in to < 56-in (1,219 to 1,422 mm) | 84-in < L ≤ 96 -in (2134mm < L ≤ 2438 mm) |
| 8 sets | 56-in to < 64-in (1,422 to 1,626 mm) | |
| 9 sets | 64-in to < 72-in (1,626 to 1,829 mm) | |
| 10 sets | 72-in to < 84-in (1,067 to 1,422 mm) | |
| 11 sets | 80-in to ≤ 84 -in (2,032 - 2,134 mm) | |

ADJUSTMENTS TO TAPER-LOC® SET SPACING BELOW

- For glass panel heights over 42-inches A_{max} and B_{max} must be reduced proportionally.
 $A_{max} = 8\frac{5}{8} * (42/h)$
 $B_{max} = 14 * (42/h)$
 h = glass panel height
- For glass panel heights under 42-inches A_{max} and B_{max} must not be increased.
- A_{min} and B_{min} are for ease of installation and can be further reduced as long as proper installation is achieved.

FIGURE 8—TAPER-LOC® SPACING

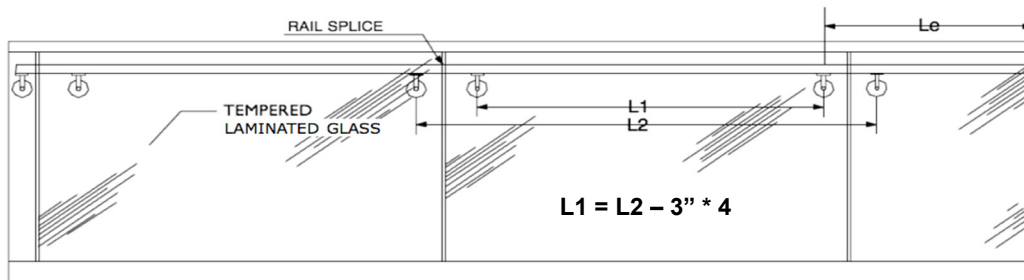

FIGURE 9—TOP RAIL AND HANDRAIL SUPPORT OPTIONS

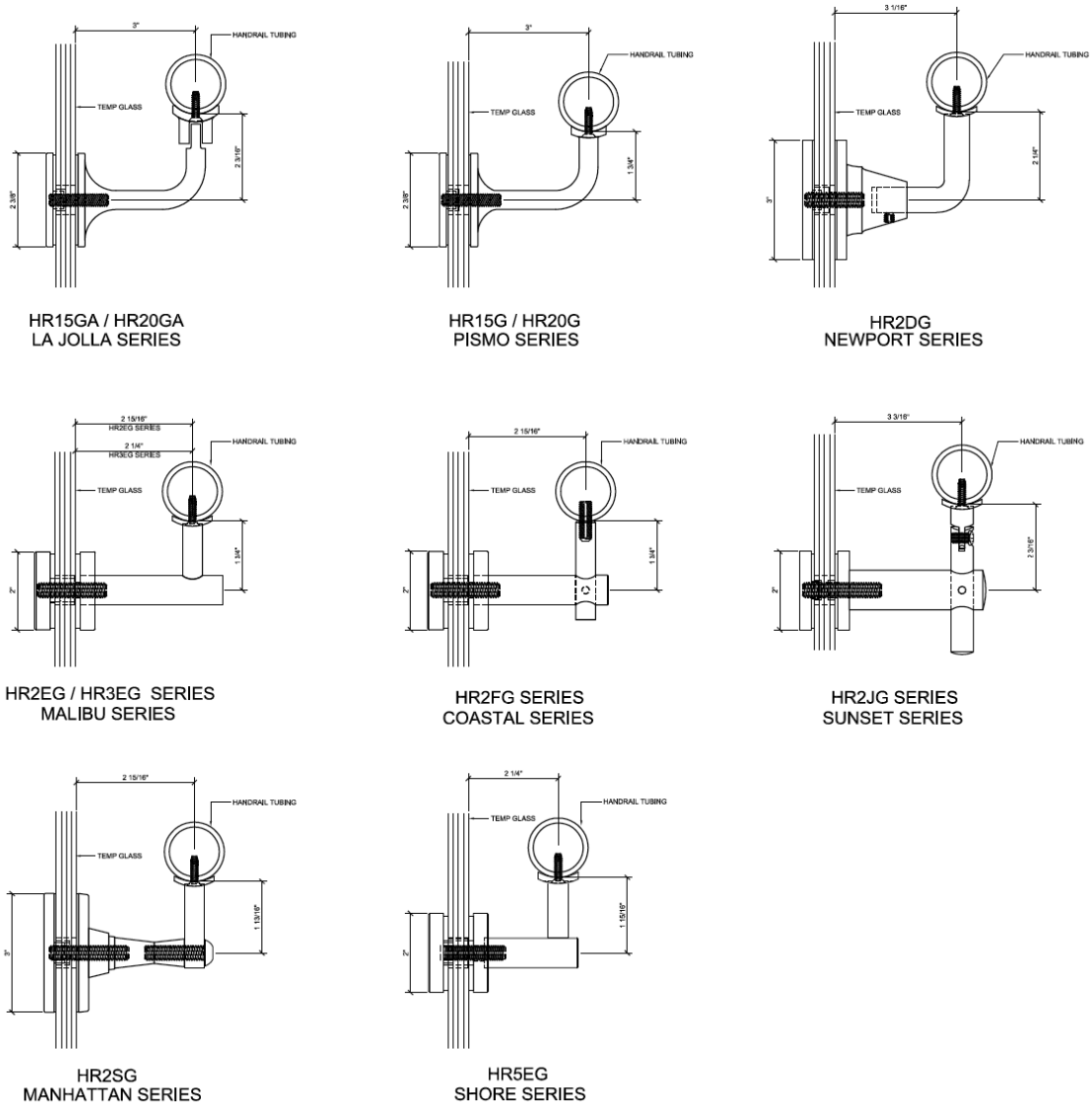

FIGURE 10—HANDRAIL BRACKETS

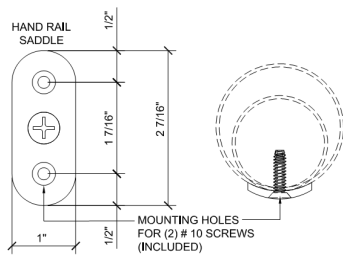

FIGURE 11—HANDRAIL ATTACHMENT

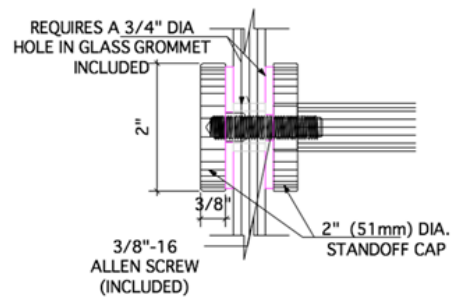

FIGURE 12—HANDRAIL ATTACHMENT TO GLASS

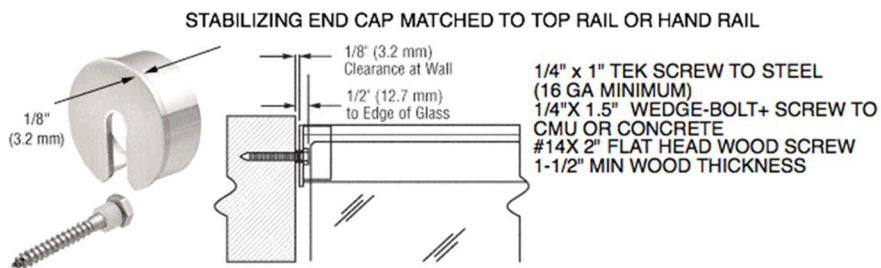

FIGURE 13—STABILIZING END CAP

DIVISION: 05 00 00—METALS

Section: 05 52 00—Metal Railings

Section: 05 73 13—Glazed Decorative Metal Railings

DIVISION: 08 00 00—OPENINGS

Section: 08 81 00—Glass Glazing

Section: 08 88 00—Special Function Glazing

DIVISION: 32 00 00—EXTERIOR IMPROVEMENTS

Section: 32 35 00—Screening Devices

REPORT HOLDER:

C.R. LAURENCE COMPANY, INC.

EVALUATION SUBJECT:**GRS™ GLASS BALUSTRADE GUARD SYSTEM FOR LAMINATED TEMPERED GLASS APPLICATIONS****1.0 REPORT PURPOSE AND SCOPE****Purpose:**

The purpose of this evaluation report supplement is to indicate that GRS™ (Glass Railing Systems), described in ICC-ES evaluation report [ESR-3842](#), have also been evaluated for compliance with the codes noted below as adopted by the Los Angeles Department of Building and Safety (LADBS).

Applicable code editions:

- 2020 *City of Los Angeles Building Code* (LABC)
- 2020 *City of Los Angeles Residential Code* (LARC)

2.0 CONCLUSIONS

The GRS™ (Glass Railing Systems), described in Sections 2.0 through 7.0 of the evaluation report [ESR-3842](#), comply with the LABC Chapters 10 and 24, and the LARC, and are subject to the conditions of use described in this supplement.

3.0 CONDITIONS OF USE

The GRS™ (Glass Railing Systems) described in this evaluation report supplement must comply with all of the following conditions:

- All applicable sections in the evaluation report [ESR-3842](#).
- The design, installation, conditions of use and identification of the GRS™ (Glass Railing Systems) are in accordance with the 2018 *International Building Code*® (IBC) provisions noted in the evaluation report [ESR-3842](#).
- The design, installation and inspection are in accordance with additional requirements of LABC Chapters 16 and 17, as applicable.
- Under the LARC, an engineered design in accordance with LARC Section R301.1.3 must be submitted.

This supplement expires concurrently with the evaluation report, reissued March 2023 and revised April 2023.

DIVISION: 05 00 00—METALS

Section: 05 52 00—Metal Railings

Section: 05 73 13—Glazed Decorative Metal Railings

DIVISION: 08 00 00—OPENINGS

Section: 08 81 00—Glass Glazing

Section: 08 88 00—Special Function Glazing

DIVISION: 32 00 00—EXTERIOR IMPROVEMENTS

Section: 32 35 00—Screening Devices

REPORT HOLDER:

C.R. LAURENCE COMPANY, INC.

EVALUATION SUBJECT:**GRS™ GLASS BALUSTRADE GUARD SYSTEM FOR LAMINATED TEMPERED GLASS APPLICATIONS****1.0 REPORT PURPOSE AND SCOPE****Purpose:**

The purpose of this evaluation report supplement is to indicate that GRS™ (Glass Railing Systems) for laminated glass, described in ICC-ES evaluation report ESR-3842, have also been evaluated for compliance with the code(s) noted below.

Applicable code edition(s):

- 2019 *California Building Code* (CBC)

For evaluation of applicable chapters adopted by the California Office of Statewide Health Planning and Development (OSHPD) AKA: California Department of Health Care Access and Information (HCAI) and the Division of State Architect (DSA), see Sections 2.1.1 and 2.1.2 below.

- 2019 *California Residential Code* (CRC)

2.0 CONCLUSIONS**2.1 CBC:**

The GRS™ (Glass Railing Systems) for laminated glass, described in Sections 2.0 through 7.0 of the evaluation report ESR-3842, comply with CBC Chapters 10 and 24, provided the design and installation are in accordance with the 2018 *International Building Code*® (IBC) provisions noted in the evaluation report and the additional requirements of CBC Chapters 10, 16 and 24, as applicable.

2.1.1 OSHPD:

The applicable OSHPD Sections and Chapters of the CBC are beyond the scope of this supplement.

2.1.2 DSA:

The applicable DSA Sections and Chapters of the CBC are beyond the scope of this supplement.

2.2 CRC:

The GRS™ (Glass Railing Systems) for laminated glass, described in Sections 2.0 through 7.0 of the evaluation report ESR-3842, comply with CRC Chapter 3, provided the design and installation are in accordance with the 2018 *International Residential Code*® (IRC) provisions noted in the evaluation report and the additional requirements of CRC Chapter 3.

This supplement expires concurrently with the evaluation report, reissued March 2023 and revised April 2023.

DIVISION: 05 00 00—METALS

Section: 05 52 00—Metal Railings

Section: 05 73 13—Glazed Decorative Metal Railings

DIVISION: 08 00 00—OPENINGS

Section: 08 81 00—Glass Glazing

Section: 08 88 00—Special Function Glazing

DIVISION: 32 00 00—EXTERIOR IMPROVEMENTS

Section: 32 35 00—Screening Devices

REPORT HOLDER:

C.R. LAURENCE COMPANY, INC.

EVALUATION SUBJECT:

GRS™ GLASS BALUSTRADE GUARD SYSTEM FOR LAMINATED TEMPERED GLASS APPLICATIONS

1.0 REPORT PURPOSE AND SCOPE**Purpose:**

The purpose of this evaluation report supplement is to indicate that the GRS™ Glass Balustrade Guard System for Laminated Tempered Glass Applications, described in ICC-ES evaluation report ESR-3842, has also been evaluated for compliance with the codes noted below.

Applicable code editions:

- 2020 Florida Building Code—Building
- 2020 Florida Building Code—Residential

2.0 CONCLUSIONS

The GRS™ Glass Balustrade Guard System for Laminated Tempered Glass Applications, described in Sections 2.0 through 7.0 of ICC-ES evaluation report ESR-3842, complies with the *Florida Building Code—Building* and *Florida Building Code—Residential*. The design requirements must be determined in accordance with the *Florida Building Code—Building* or the *Florida Building Code—Residential*, as applicable. The installation requirements noted in ICC-ES evaluation report ESR-3842 for the 2018 *International Building Code*® (IBC) meet the requirements of the *Florida Building Code—Building* or the *Florida Building Code—Residential*, as applicable.

Use of the GRS™ Glass Balustrade Guard System for Laminated Tempered Glass Applications for compliance with the High-Velocity Hurricane Zone provisions of the *Florida Building Code—Building* or the *Florida Building Code—Residential* has not been evaluated and is outside the scope of this supplemental report.

For products falling under Florida Rule 61G20-3, verification that the report holder's quality assurance program is audited by a quality assurance entity approved by the Florida Building Commission for the type of inspections being conducted is the responsibility of an approved validation entity (or the code official when the report holder does not possess an approval by the Commission).

This supplement expires concurrently with the evaluation report, reissued March 2023 and revised April 2023.