

Revisions By:



Description
**CURTAIN DOOR
BALANCER**

Drawn by:

Date:

Scale:

File name:

Sheet

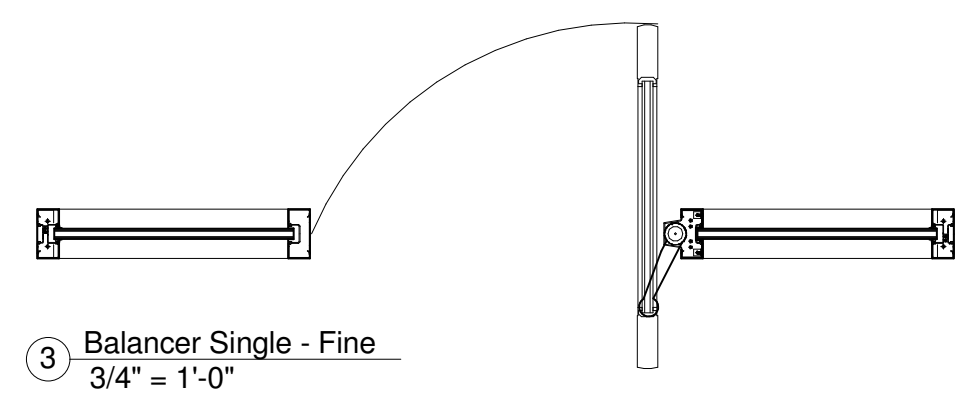

3 Balancer Single - Fine
3/4" = 1'-0"

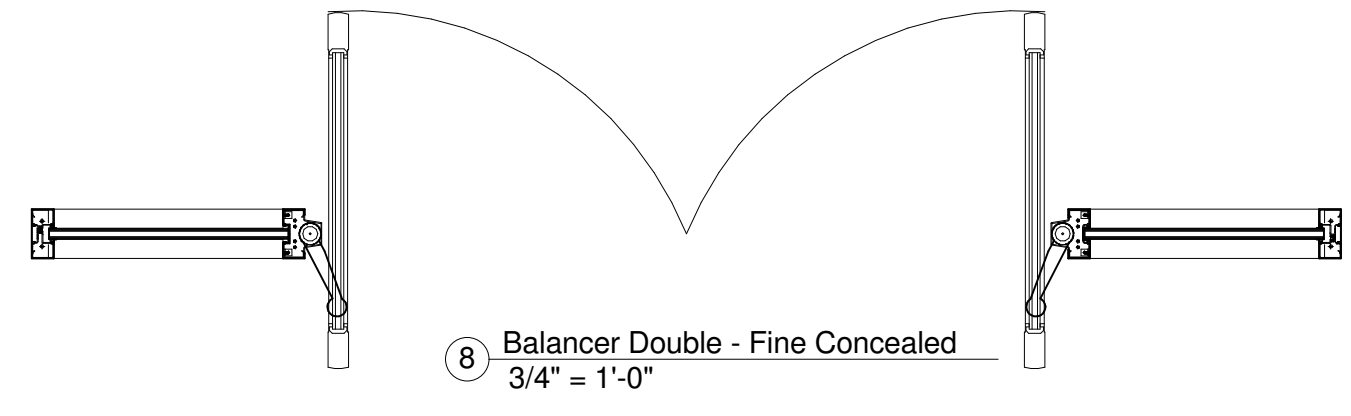

8 Balancer Double - Fine Concealed
3/4" = 1'-0"

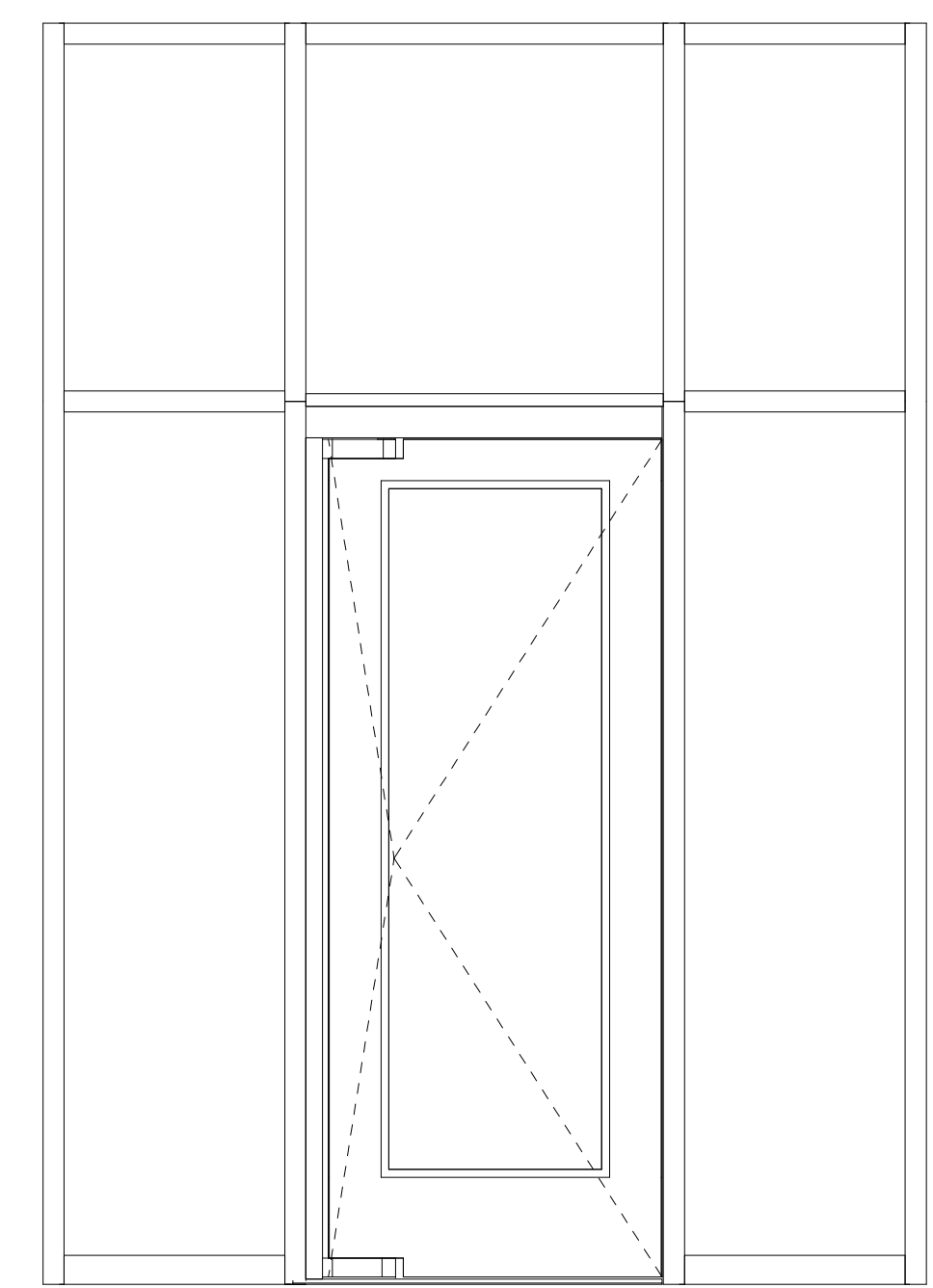

1 Balancer Single Elevation
3/4" = 1'-0"

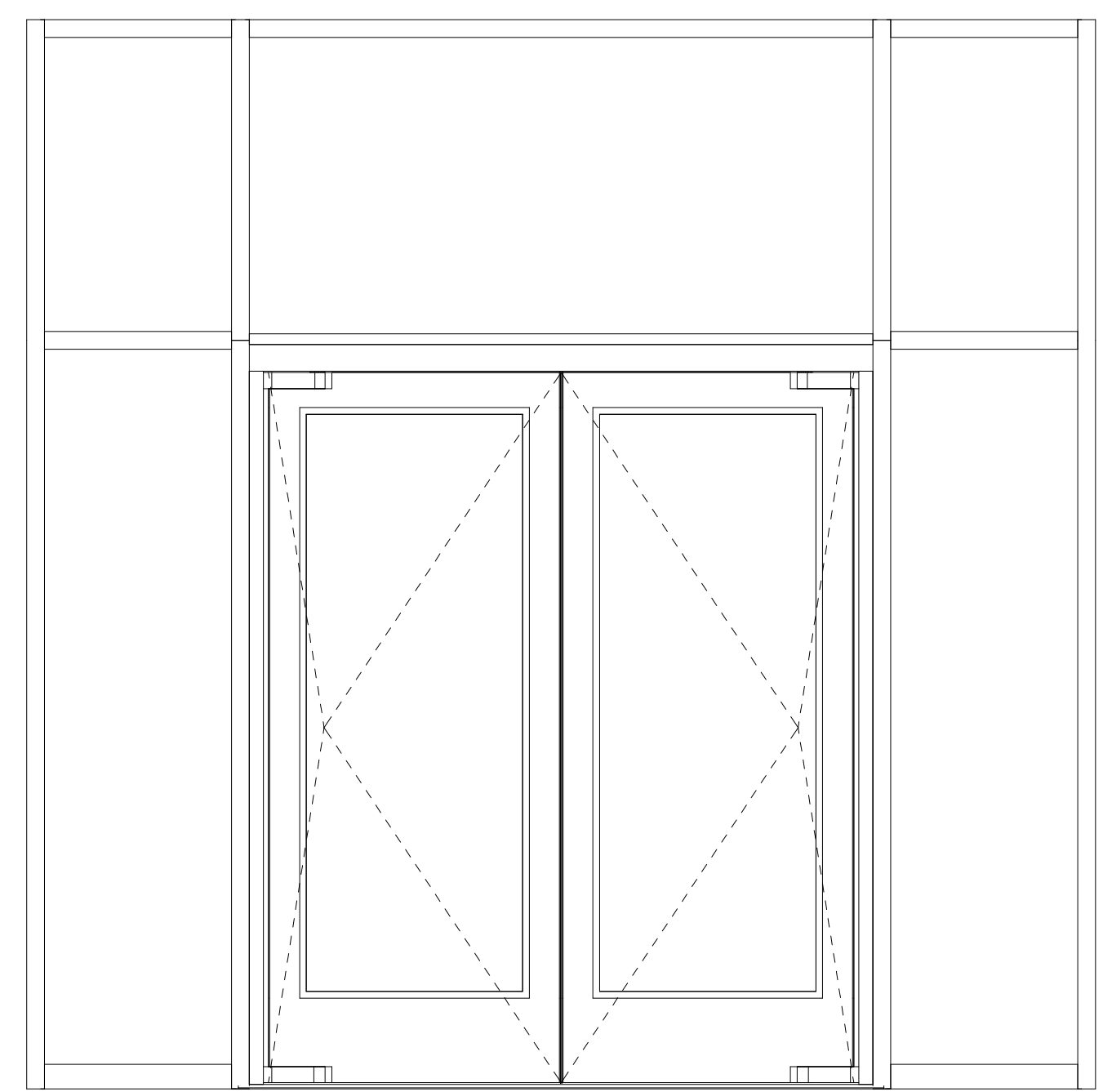

2 Balancer Double Elevation Concealed
3/4" = 1'-0"

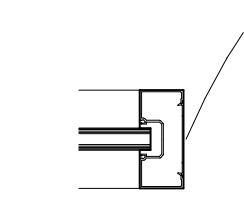

6 Balancer Jamb
1 1/2" = 1'-0"

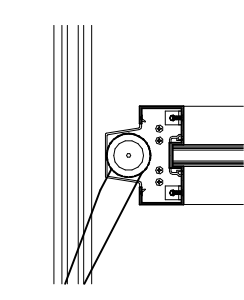

7 Balancer Hinge Jamb
1 1/2" = 1'-0"

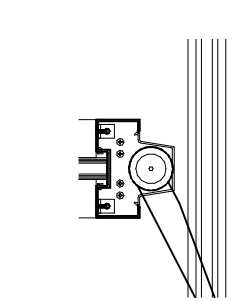

12 Balancer Jamb-Concealed
1 1/2" = 1'-0"

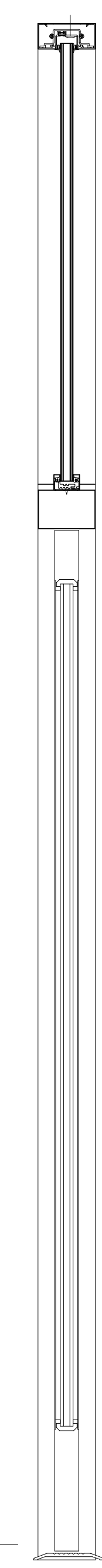

11 Balancer Section
1 1/2" = 1'-0"