

**3/4" (25mm) Diameter Brass Tubing**  
**Glass Thickness Range: 1/4" to 1/2" (6mm to 12 mm)**  
**Hole Diameter Required: 1/2" (12mm) (2)**

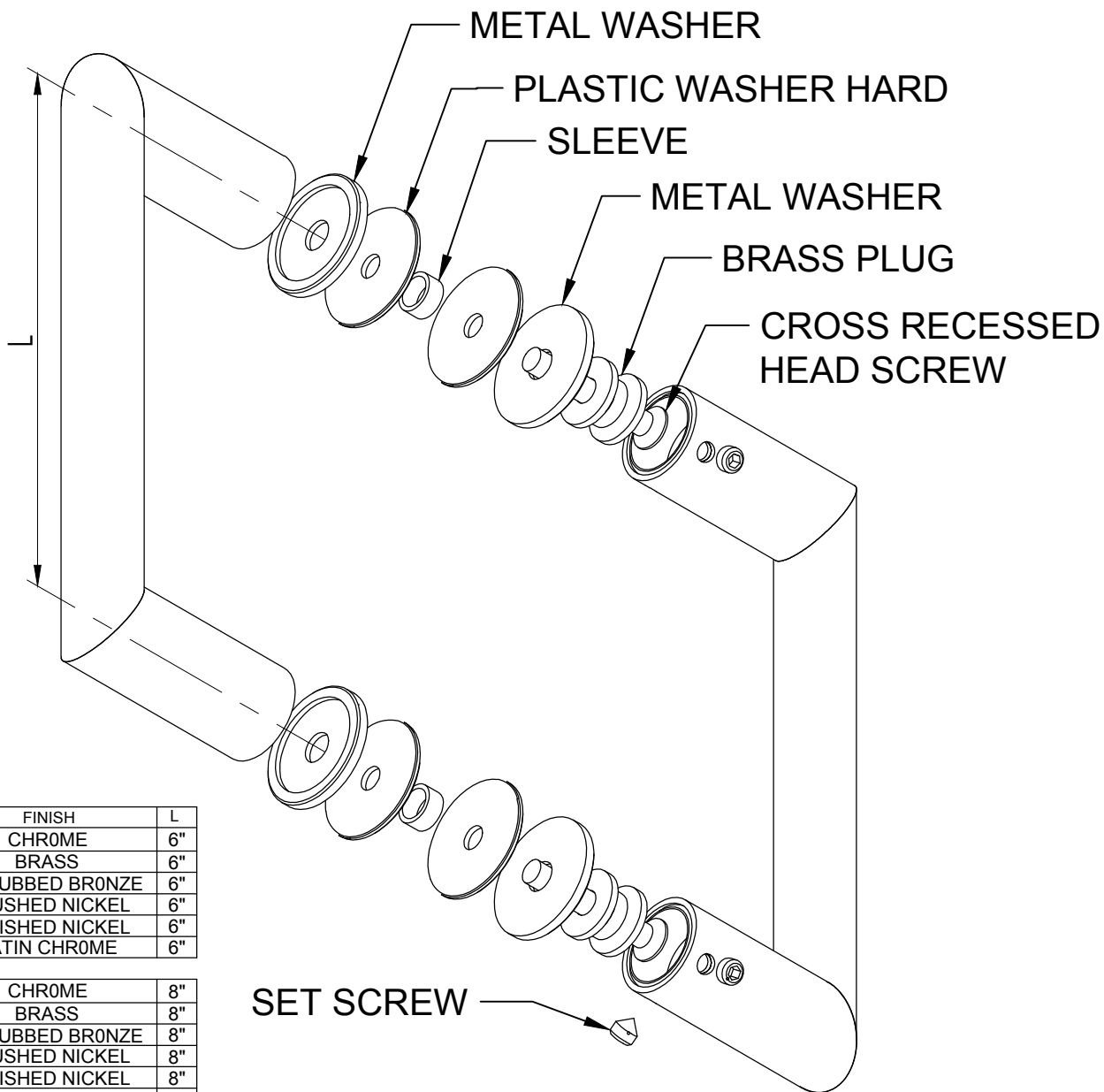

PART NUMBER	FINISH	L
0R6X6CH	CHROME	6"
0R6X6BR	BRASS	6"
0R6X6RB	OIL RUBBED BRONZE	6"
0R6X6BN	BRUSHED NICKEL	6"
0R6X6PN	POLISHED NICKEL	6"
0R6X6SC	SATIN CHROME	6"

0R8X8CH	CHROME	8"
0R8X8BR	BRASS	8"
0R8X8RB	OIL RUBBED BRONZE	8"
0R8X8BN	BRUSHED NICKEL	8"
0R8X8PN	POLISHED NICKEL	8"
0R8X8SC	SATIN CHROME	8"

0R18X18CH	CHROME	18"
0R18X18BR	BRASS	18"
0R18X18RB	OIL RUBBED BRONZE	18"
0R18X18BN	BRUSHED NICKEL	18"
0R18X18PN	POLISHED NICKEL	18"
0R18X18SC	SATIN CHROME	18"

0R24X24CH	CHROME	24"
0R24X24BR	BRASS	24"
0R24X24RB	OIL RUBBED BRONZE	24"
0R24X24BN	BRUSHED NICKEL	24"
0R24X24PN	POLISHED NICKEL	24"
0R24X24SC	SATIN CHROME	24"



C.R.LAURENCE CO. ARCHITECTURAL PRODUCTS  
 2503 E. Vernon Avenue, Los Angeles, C.A 90058-1897  
 PH (800)-421-6144 FX: 800-587-7501 www.crlaurence.com

DESCRIPTION:  
 CRL OR SERIES OVAL / ROUND PULL HANDLE  
 PART #:  
 SEE CHART

DATE: 11/7/2018  
 SCALE: NTS  
 DRAWN BY: VM