

INSTALLATION INSTRUCTIONS

CRL SERIES SCDW4836 / SCDW4836S HEAVY DUTY SELF-CLOSING SERVICE WINDOW STANDARD SIZE MODELS



SCDW4836 Standard Aluminum Half
Track Shown from Clerk Side
(No Track under Sliding Panel)



SCDW4836S Standard Stainless Steel
Step Sill Shown from Clerk Side
(Water Dam for Exterior Applications)

CRL[®]

Phone: (800) 395-2212 • Fax: (800) 458-7496
Email: transaction@crlaurence.com
crlaurence.com • usalum.com • crl-arch.com

TABLE OF CONTENTS

INTRODUCTION	3
STANDARD MODEL NUMBERS AND DESCRIPTIONS	3
SCDW4836 Standard Half Track Models:	3
SCDW4836S Standard Step Sill Models:	3
Part Number Logic	3
SPECIFICATIONS	4
GLAZING GUIDELINES	5
Glass Fabrication	5
Glazing Vinyl	5
WINDOW BENCH TEST CHECKLIST	5
Included Materials	5
Recommended Tools and Materials (Not Included)	5
INSTALLATION REQUIREMENTS	6
Confirm a Square and Level Opening	6
Working with an Out-of-Square / Unlevel Opening	6
GLAZING	7 - 9
Re-Glazing Panels (Installed Units)	9
SELF-CLOSING SPEED ADJUSTMENT	10
SCDW4836 HALF TRACK INSTALLATION	11 - 12
Perimeter Sealing and Finishing	12
SCDW4836S STEP SILL INSTALLATION	12

IMPORTANT: READ THIS MANUAL THOROUGHLY BEFORE BEGINNING INSTALLATION

INTRODUCTION

CRL Standard Size Self-Closing Service Windows are shipped fully assembled, ready to glaze or factory glazed and ready to install. They are designed for heavy-duty commercial use such as drive-thru or walk-up service and are also popular for interior applications needing a self-closing function.

STANDARD MODEL NUMBERS AND DESCRIPTIONS

NOTE: All Standard Models Below are 47-1/2" Wide by 35-3/4" High Net Frame Size.

SCDW4836 Standard Half Track Models:

Aluminum track under fixed panel, no track under sliding panel for clear counter area.

Half Track requires overhang in exterior applications.

MODEL NUMBER	"OX" Clerk Side X = Sliding	"XO" Clerk Side X = Sliding	"G" Glazed 1/4" Tempered Glass	"U" Unglazed 1/4" and 1/2" Vinyl Provided	"A" Satin Anodized Finish	"DU" Duranodic Bronze Finish
SCDW4836OXGA	✓		✓		✓	
SCDW4836OXUA	✓			✓	✓	
SCDW4836XOGA		✓	✓		✓	
SCDW4836XOUA		✓		✓	✓	
SCDW4836OXGDU	✓		✓			✓
SCDW4836OXUDU	✓			✓		✓
SCDW4836XOGDU		✓	✓			✓
SCDW4836XOUDU		✓		✓		✓

SCDW4836S Standard Step Sill Models:

Continuous Stainless Steel Sill creates water dam.

Step Sill designed for exterior use when no overhang is available.

MODEL NUMBER	"OX" Clerk Side X = Sliding	"XO" Clerk Side X = Sliding	"G" Glazed 1/4" Tempered Glass	"U" Unglazed 1/4" and 1/2" Vinyl Provided	"A" Satin Anodized Finish	"DU" Duranodic Bronze Finish
SCDW4836SOXGA	✓		✓		✓	
SCDW4836SOXUA	✓			✓	✓	
SCDW4836SXOGA		✓	✓		✓	
SCDW4836SXOUA		✓		✓	✓	
SCDW4836SOXGDU	✓		✓			✓
SCDW4836SOXUDU	✓			✓		✓
SCDW4836SXOGDU		✓	✓			✓
SCDW4836SXOUDU		✓		✓		✓

Part Number Logic

SCDW4836 STANDARD HALF TRACK MODELS

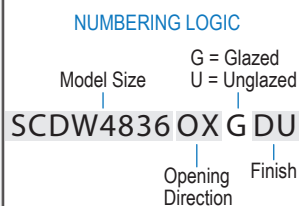
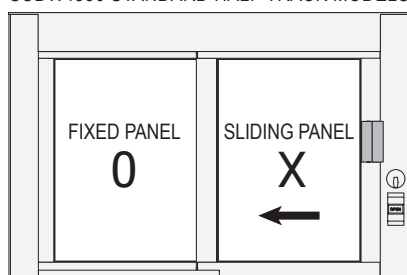

SCDW4836S STANDARD STEP SILL MODELS

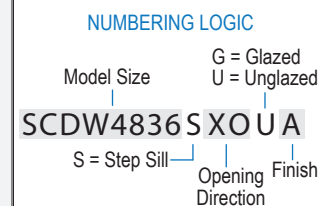
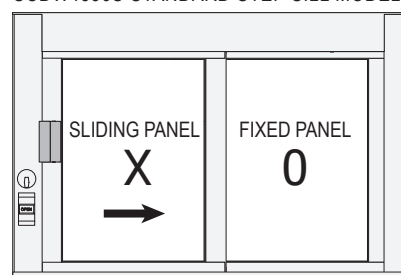

SPECIFICATIONS

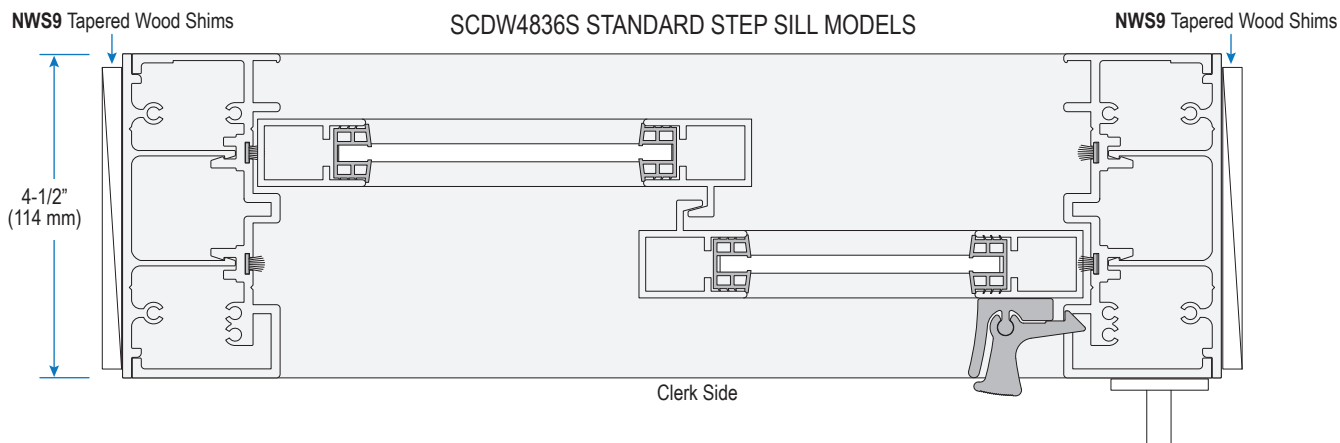
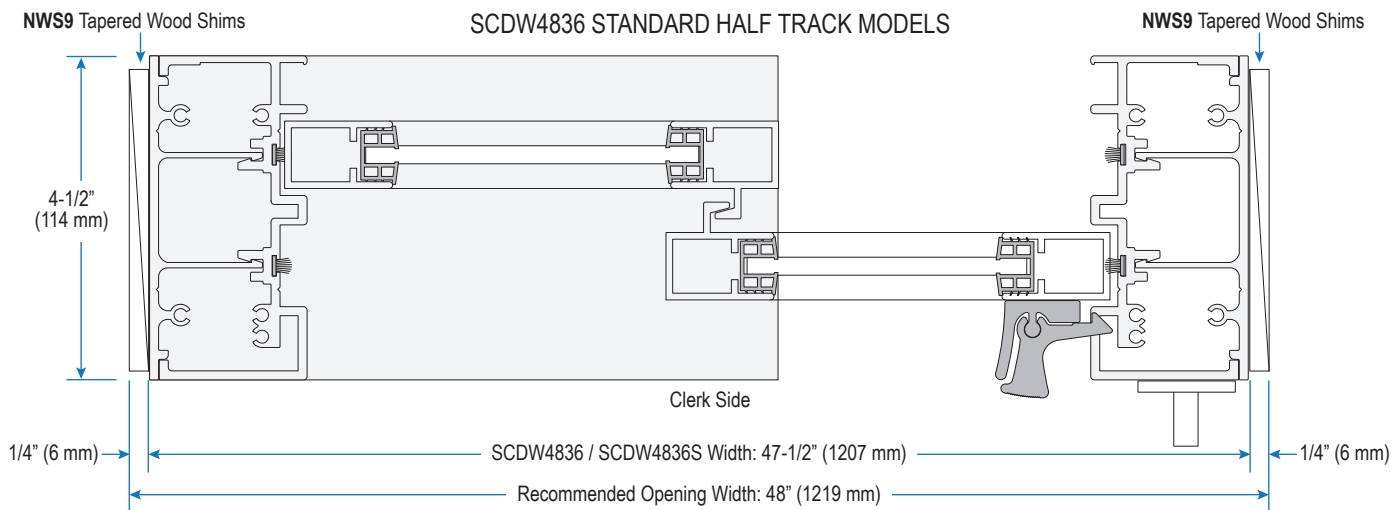
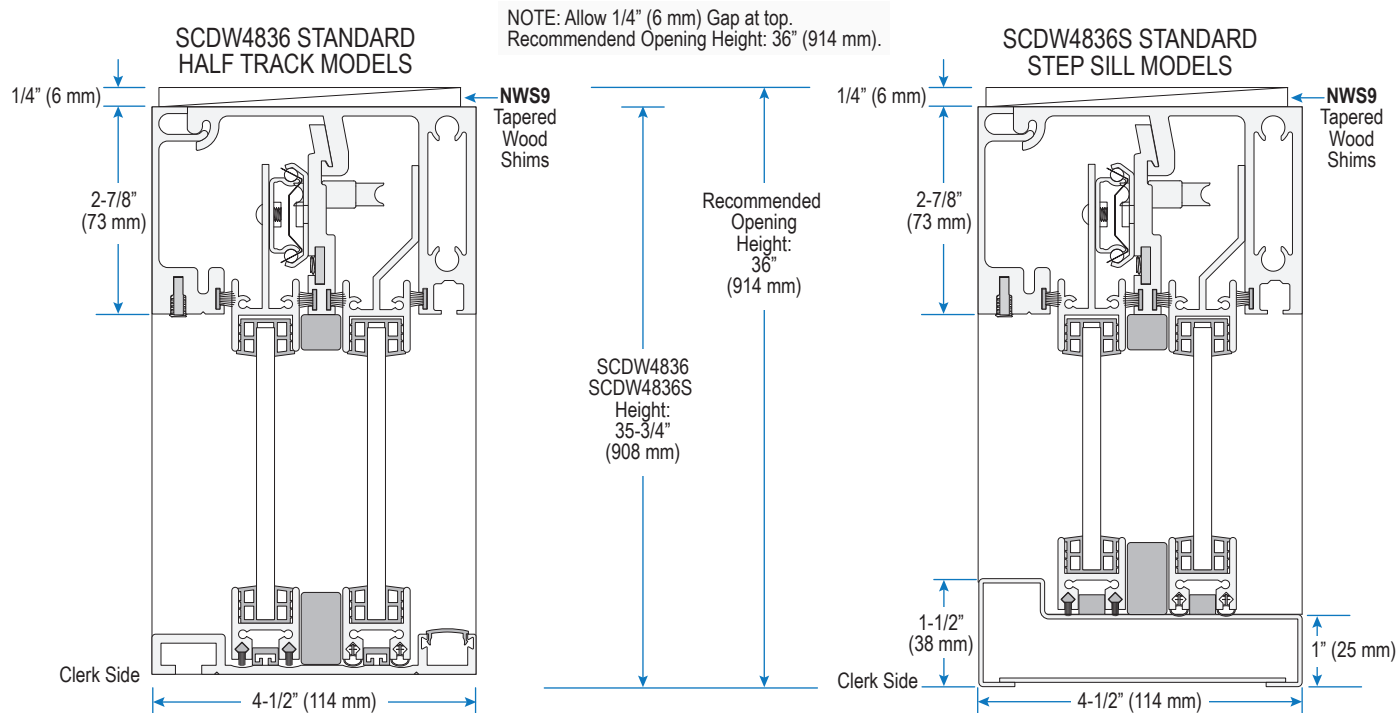

GLAZING GUIDELINES

NOTE: Disregard this section for Glazed Units.

Glass Fabrication

If you ordered your Deluxe Service Window unglazed, fabricate two equal panels with dimensions listed.

Model Type	Width	Height
SCDW4836 Standard Half Track Models	20-1/4" (514 mm)	31-15/16" (811 mm)
SCDW4836S Standard Step Sill Models	20-1/4" (514 mm)	30-15/16" (786 mm)

Glazing Vinyl

Unglazed Models include two sets of glazing vinyl: one for 1/4" glass, and one for 1/2" glass. The larger vinyl will also accept 9/16" glazing.

For 5/8" glass (maximum glass thickness), order CRL **Cat. No. WV3865** separately, 100 foot minimum.

For 3/8" glass, use included 1/2" vinyl with CRL **Cat. No. 982116X34GRY** double-sided adhesive foam tape, sold separately, 200 foot minimum. Wrap edges of glass with tape, leaving backing on edge that enters 1/2" vinyl channel.

IMPORTANT: THE FOLLOWING INSTRUCTIONS WILL REDUCE YOUR CHANCES OF EXPERIENCING PROBLEMS DURING INSTALLATION. PLEASE READ CAREFULLY BEFORE INSTALLING WINDOW.

WINDOW BENCH TEST CHECKLIST

IMPORTANT: Inspect your window and immediately advise CRL of any damage or abnormalities.

1. Unpack the window and remove the wood blocking used to prevent the sliding panel from moving during transit.
2. Bench test the window: Squeeze self-latching handle to unlock sliding panel, and slide panel to open. Let the self-closing mechanism operate to close. Confirm a smooth, consistent open/close slide and ensure the self-latching handle engages fully in its strike slot in the jamb when the window closes itself. Test the thumb turn deadlatch indicator.

NOTE: Unglazed models will close a little more quickly during bench test than they will close after they have been glazed, due to the weight of the glass.

3. Tighten any screws that may have loosened during shipping and confirm panel and perimeter frames are square. Test the slide and the latch engagement again after making any adjustments.

NOTE: If you are unsure how to confirm a frame is square, or have difficulty achieving smooth slides and tight latch engagement during bench tests, contact CRL for assistance.

Unglazed Models: See above for Glass Fabrication and Pages 7 - 9 to glaze the unit before installing.

Included Materials

- Window and Components
- 3 oz. tube of 22C Clear Silicone. Use as needed to fill any small gaps between frame members.
NOTE: This tube is not intended to fill the perimeter caulk gap.
- #10 Flat Head Phillips Stainless Steel Wood Screws. NOTE: For opening substrates requiring different fasteners provided by installer, ensure a good fit with factory drilled countersunk holes in perimeter frame.

Recommended Tools and Materials (Not Included)

- Power Drill
- Caulking Gun
- Phillips Screw Driver
- Allen Wrench
- CRL **Cat. No. 199** Utility Knife
- CRL **Cat. No. NWS9** Tapered Wood Shims
- CRL **Cat. No. 1973** Glass Cleaner
- CRL **Cat. No. 1550** Lint Free Shop Towels
- CRL **Cat. No. M64** Construction Sealant (Select Color)
- Fasteners / Anchors by Installer *

* If supplied wood screws are not appropriate for field conditions.

INSTALLATION REQUIREMENTS

After bench testing the window thoroughly (see Page 5), confirm the wall opening meets the installation requirements for the window.

Confirm a Square and Level Opening

Review and measure the opening. Verify framing is plumb, straight, and true around window opening.

Confirm the opening is square and level. Measure opening diagonally to check squareness.

Verify the window rough opening width and height match the recommended dimensions listed. Measure opening at each end and at center vertically and horizontally. Make corrections to openings as required.

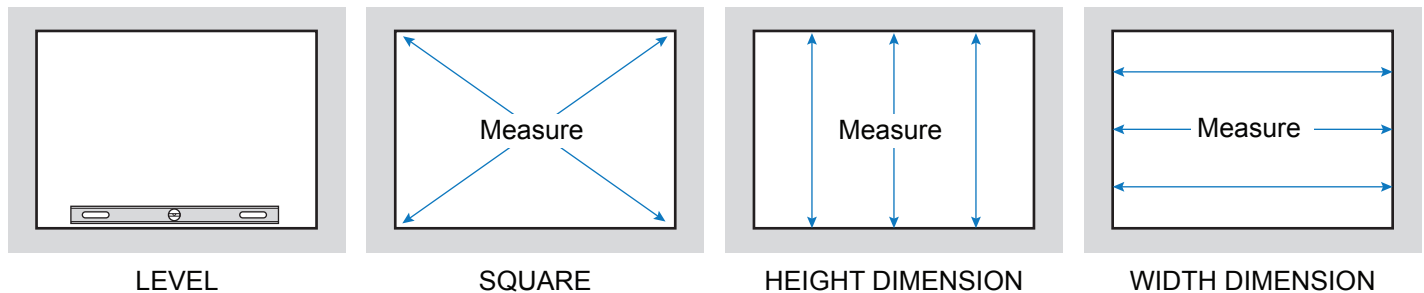

Recommended Rough Opening Width:	48" (1219 mm)
Recommended Rough Opening Height:	36" (914 mm)

NOTE: The recommended rough opening dimensions are based on 1/4" (8 mm) gap at each side and at the top with the bottom member of the window frame flat on the bottom surface of the wall opening.

Some installers may prefer to have a greater clearance on height, and to add additional shims under the bottom member of the window. If so, this may need to be coordinated with other trades before the window is ordered and/or before the opening is made.

Small variations in clearance are acceptable as long as, when installation is complete, the window frame itself is square and level, operating smoothly, and held securely to maintain that condition.

Confirm that there are no obstructions in the opening that interfere with using the factory drilled countersunk holes in the frame to drive fasteners into the substrate. If there are, determine the best alternate locations to drill and countersink new holes, making sure the countersinks allow the screw head to be flush or slightly below the frame outer surface.

NOTE: If you are unsure how to confirm an opening is square and level, or have questions about differences from the recommended clearances, contact CRL for assistance.

Working with an Out-of-Square / Unlevel Opening

See Pages 11 - 12 and familiarize yourself with the basic steps needed to complete a proper installation.

If your wall opening is not square, and/or has an unlevel bottom, confirm that there is enough room to fit the entire window frame within the opening, and that the uneven gaps can be filled with shims so that the end result is a window frame that can operate smoothly and be held securely in a square and level condition.

If these requirements cannot be met, correct the opening. Depending on the extent of the out-of-square wall condition, cosmetic steps in addition to final caulk joint may be needed. Contact CRL for assistance.

NOTE: Before beginning installation, see Page 7 - 9 for Glazing Instructions and Page 10 for Speed Adjustment Instructions.

GLAZING

NOTE: Glaze Sliding and Fixed Panels before installing the unit in opening. SCDW4836 Half Track OX Model Shown. Others similar.

1. Uniformly wrap single Gasket length around each glass panel. Notch at corners and center joint at top.
2. **Remove Access Panel.** Locate Steel Shim with Set Screw on Clerk Side bottom edge of Access Panel at each jamb. Loosen Set Screws and slide Shims to center to remove Access Panel. **NOTE:** Shims and Set Screws will disengage from Access Panel. Set aside in safe place.
3. **Disable self-closing mechanism.** At the top Sliding Panel, locate the Phillips screw closest to the strike jamb. Loosen this screw to detach the cable hanger, taking care to hold the end of the cable securely. Guide the cable slowly until it comes to rest against the receiving pulley. **Use caution: the cable will retract rapidly if released too soon.**
4. **Detach Fixed Panel side Jamb** by removing screws at top and bottom of the frame (Aluminum Half Track or Stainless Steel Step Sill).

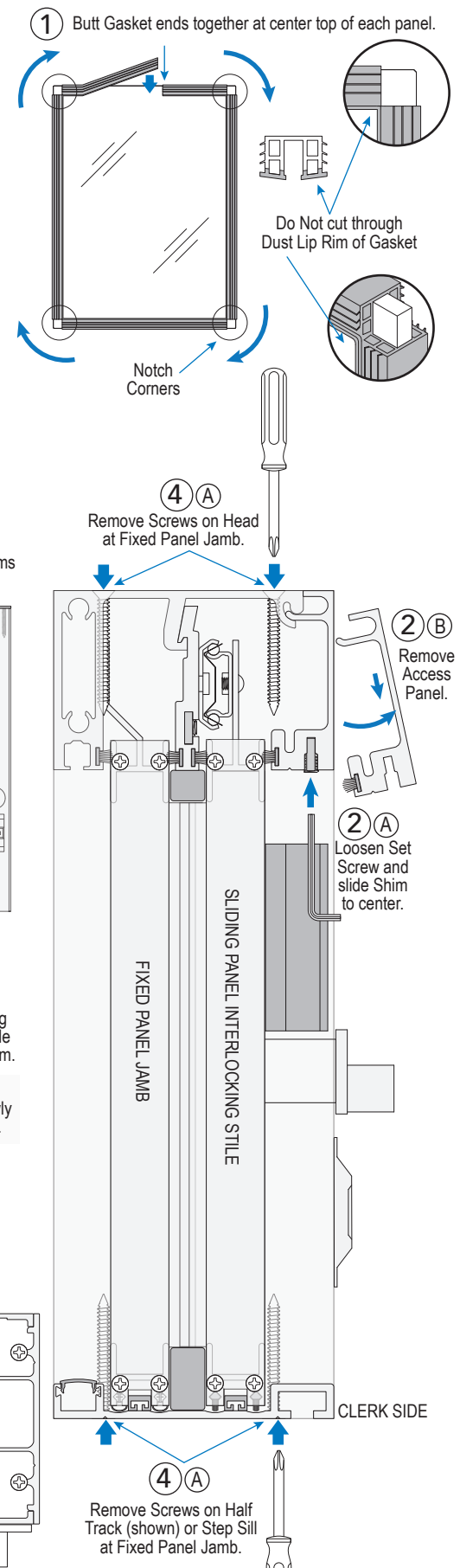
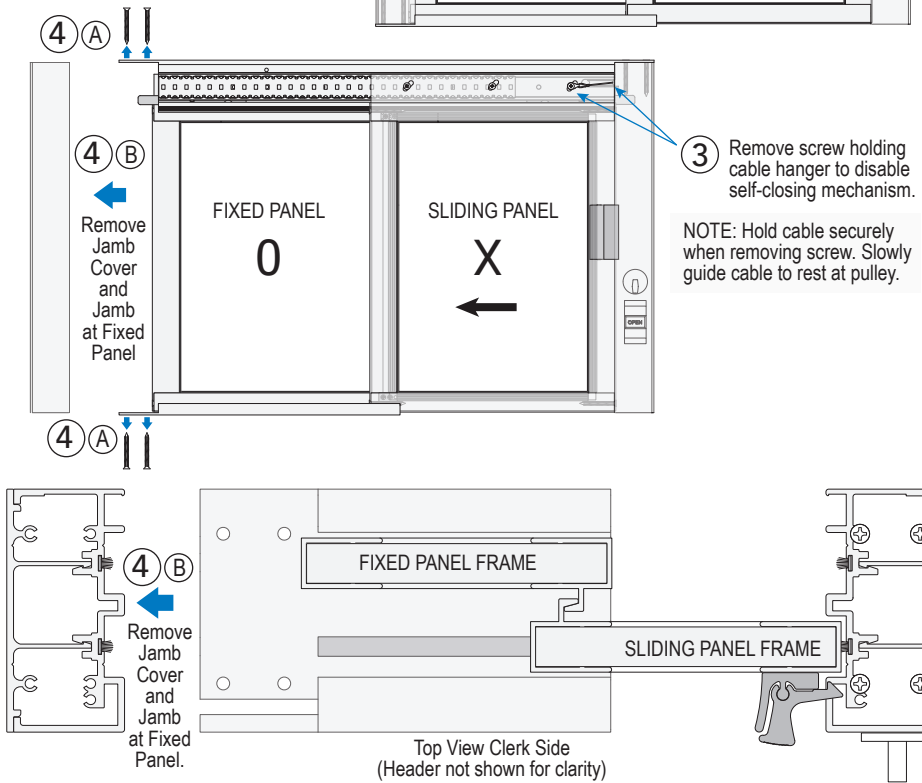

GLAZING (CONTINUED)

5. Open Sliding Panel and remove Interlocking Stile by loosening Phillips head screws at top and bottom.
6. Lubricate gasket on one glass panel with a mild solution of soapy water and insert the glass into the Sliding Panel Frame.
7. Re-install the Sliding Panel Interlocking Stile.
8. Repeat Steps 5 - 7 to glaze Fixed Panel. **NOTE:** Remove Fixed Panel Jamb instead of Fixed Panel Interlocking Stile.
9. Replace the Fixed Panel side perimeter Jamb.

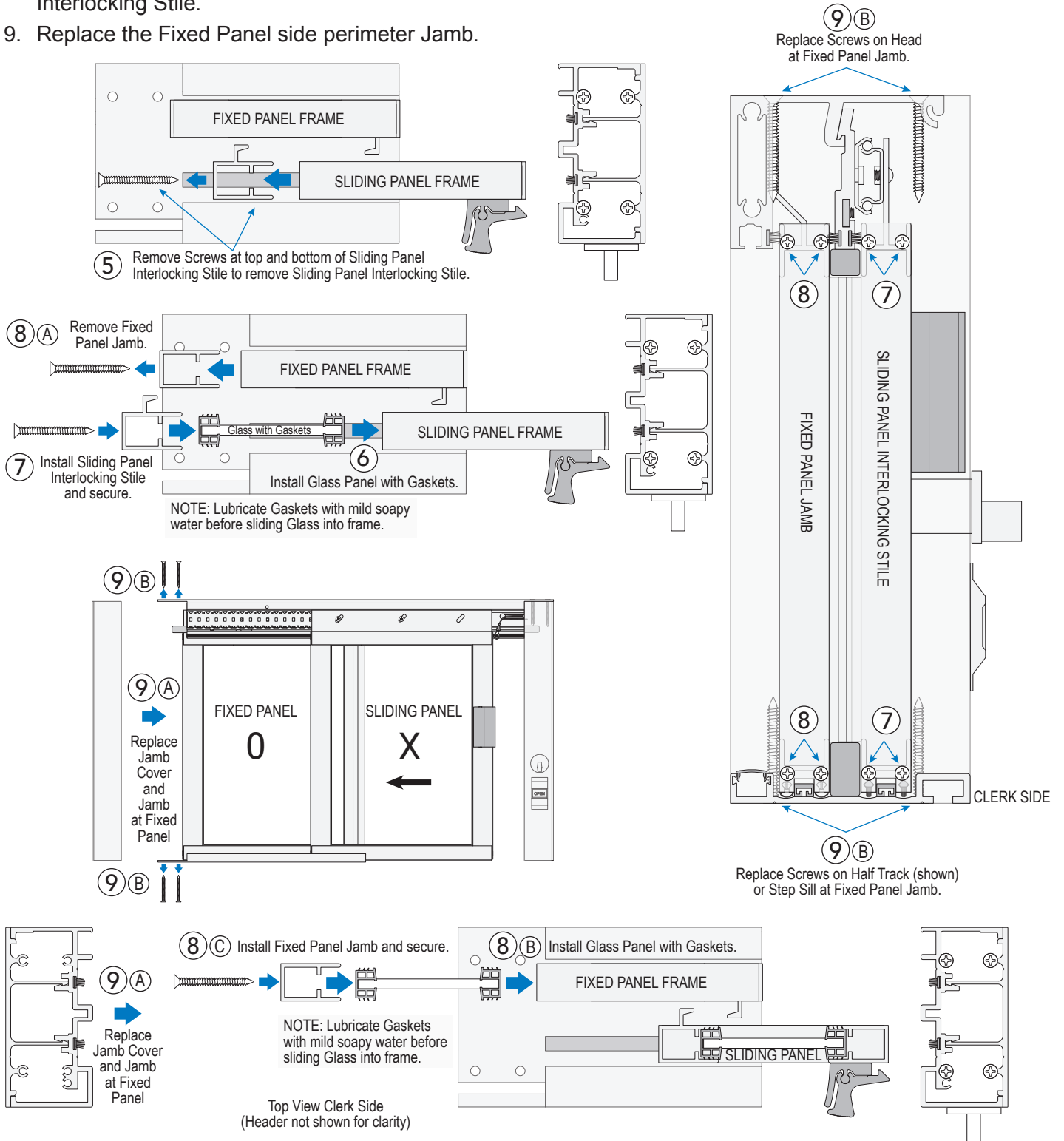

GLAZING (CONTINUED)

10. Re-attach the cable hanger to its original position. Carefully bench test the window. Confirm smooth, consistent open/close slide, confirm good engagement of the self-latching handle in its strike slot in the jamb, and confirm the perimeter frame and glass panel frames are square.

NOTE: If the speed of the self-closing panel needs to be adjusted, see instructions on Page 10.

11. Replace the Access Panel. Insert shims to secure. If necessary, use the supplied tube of 22C silicone to seal the joints on the back of the jamb where it was detached from the header and bottom member during glazing.

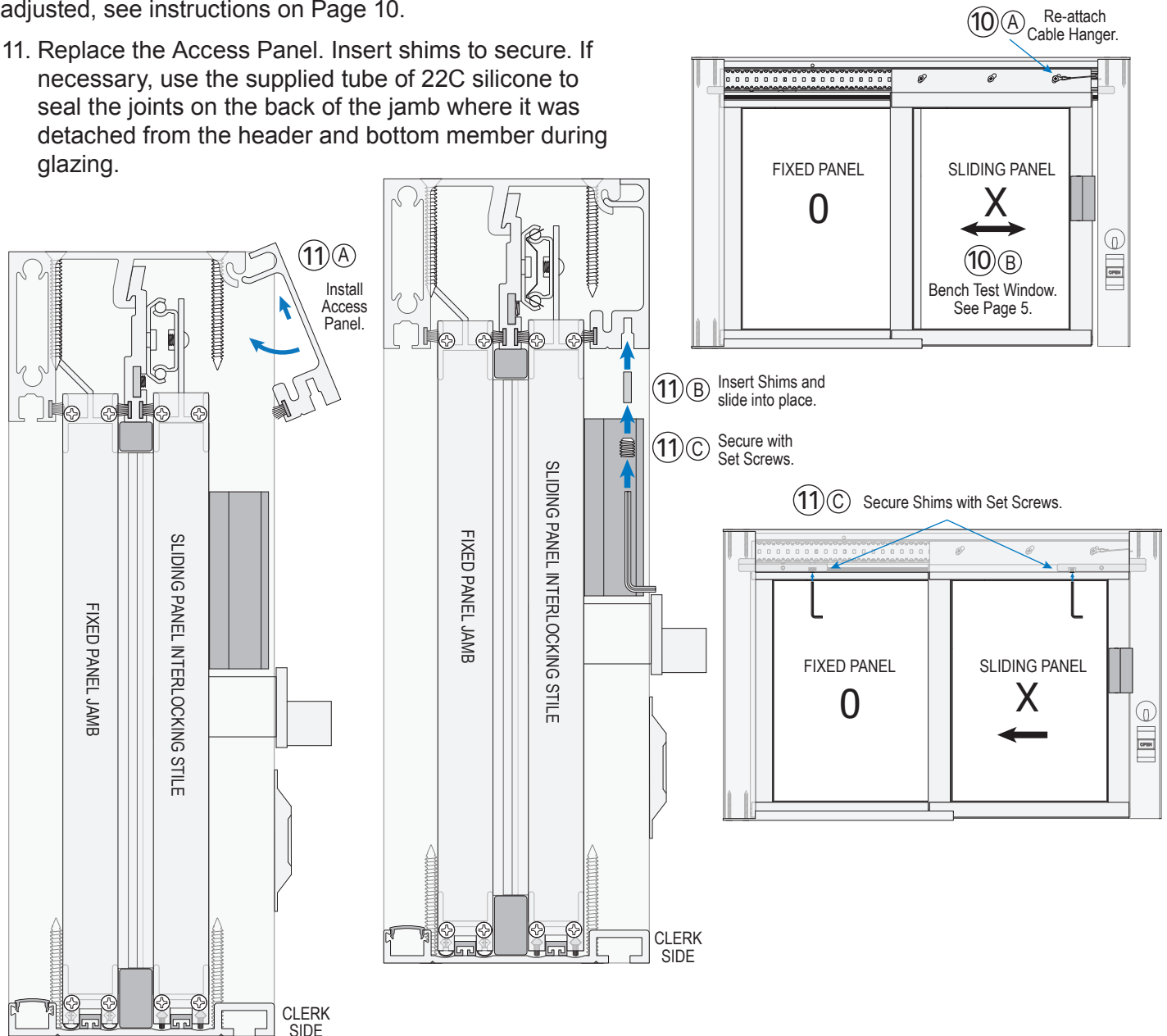

Re-Glazing Panels (Installed Units)

NOTE: Review Glazing Steps 1 - 11 before beginning.

To replace glass on installed units, both the Sliding and Fixed Panels must be accessed by removing the Header Access Panel and the Interlocking Stiles at the center of the unit. To access the Fixed Panel, it may be necessary to remove the entire Sliding Panel (see cable detachment notes above) and the black Filler Block at the bottom of the Interlocking Stiles. If the Sliding Panel is removed, be sure to use Loctite (not supplied) when re-attaching to the Glide Assembly. Contact CRL with questions.

SELF-CLOSING SPEED ADJUSTMENT

NOTE: Most windows will not require a speed adjustment when first installed. However, various factors may affect the speed setting of the hydraulic closer before or after installation.

Before adjusting the closer mechanism, consider factors not related to the hydraulic closer that may be affecting the speed with which the sliding panel closes:

- Has the window been glazed already? Adding glass will make the window close more slowly.
- Is the sliding panel dragging at the bottom? Check the hang of the Sliding Panel and check for debris or sticky residue in the lower pile that may be slowing the window.
- Check the engagement of the Sliding Panel with the pile at the bottom inside edge of the Header Access Panel.

1. Follow Glazing Steps 2 and 3 on Page 7 to remove Header Access Panel and detach cable hanger.
2. Remove Sliding Panel completely from the Ball Bearing Glide Assembly.
3. Remove the Center Divider with Ball Bearing Glide Assembly. Loosen Set Screws on steel shims and slide Shims to center. Lift up and out of Header. Handle with care.
4. Hold the Closer Shaft and rotate the Closer Body to change speed. Complete at least five full rotations before testing results.

NOTE: During adjustment, take care to maintain tension on the cable, and be sure the cable remains properly engaged in the concave groove of the pulleys.

5. When adjustment is complete secure Closer to Center Divider. Replace Center Divider, slide Steel Shims into place and secure Set Screws. Hang the Sliding Panel and re-attach the cable hanger. Use Loctite (not included) when tightening the screws for the last time. Check for smooth slide and full engagement of self-latching handle and thumb turn latch before final tightening.
6. Replace the Header Access Panel, using the Steel Shims and Set Screws.

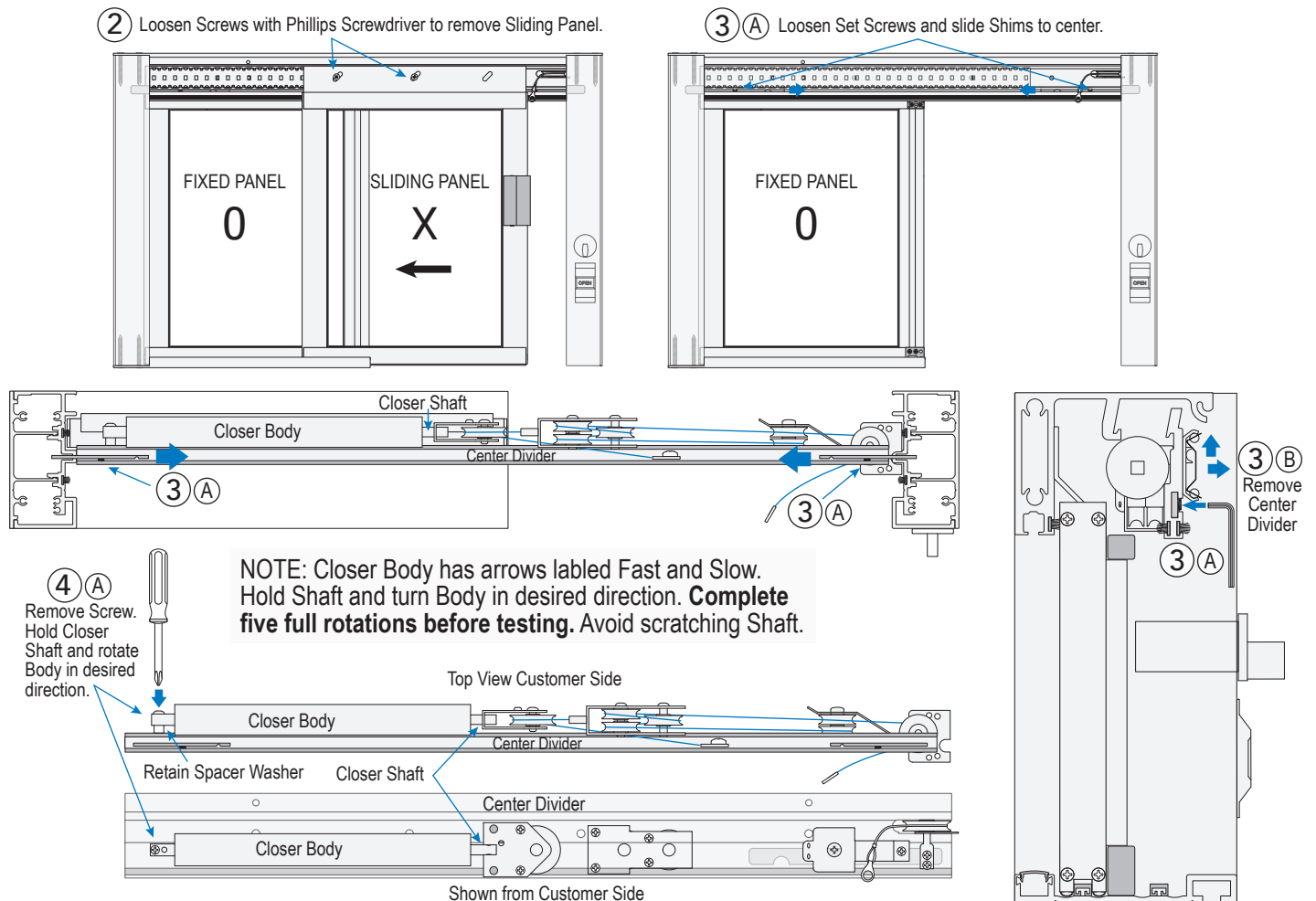

SCDW4836 HALF TRACK INSTALLATION

- Center window in opening, with the bottom frame sitting on the base. Starting at top, shim down both sides with CRL **Cat. No. NWS9** Tapered Wood Shims (not included) at equal intervals paired on inside and outside. Insert #10 Flat Head Screws at top hole on each side, do not completely tighten. Continue shimming and inserting screws in holes in sides. Check for squareness and a tight fit, and tap shims deeper if necessary. Shim and secure across top of the frame using the same procedures, and then secure Half Track to the base.
- Ensure sliding panel slides freely and the latch engages securely. If the window is NOT operating correctly, review the installation procedure. If the window appears to be installed properly but does not operate correctly, call CRL for assistance.
- When everything is operating smoothly, trim shims so they don't protrude beyond the frame with CRL **Cat. No. 199** Utility Knife (not included).

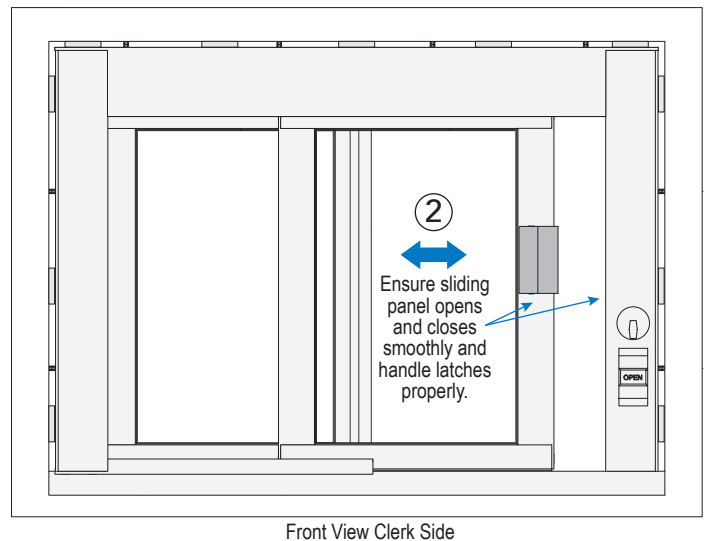
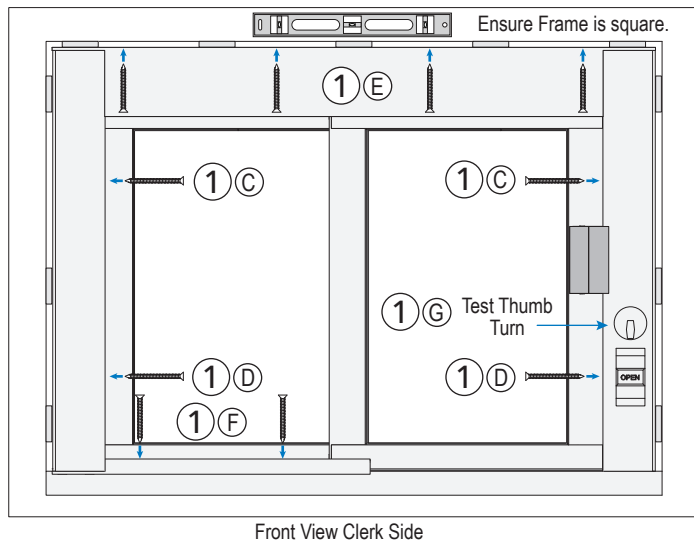
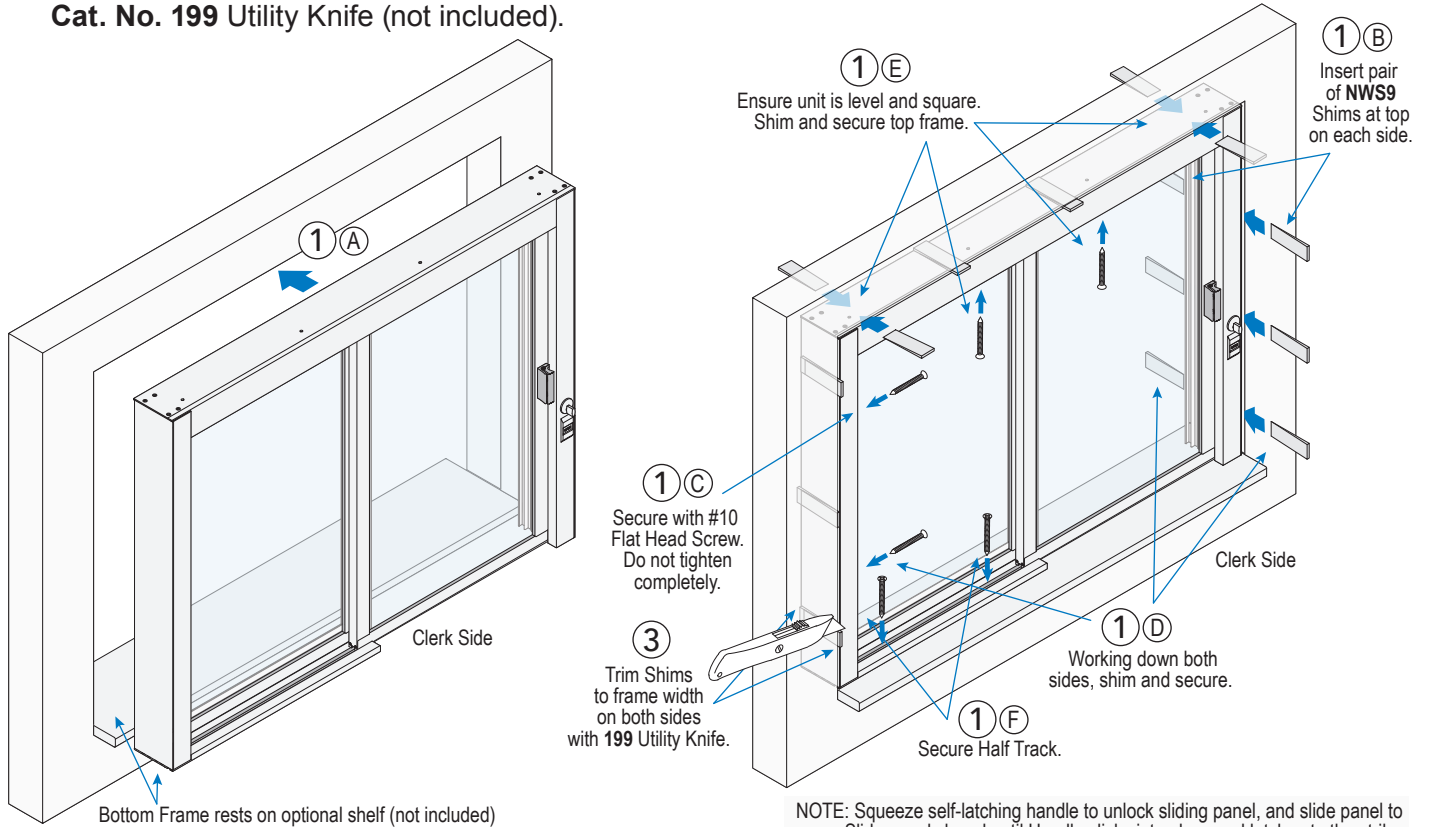

SCDW4836 HALF TRACK INSTALLATION (CONTINUED)

Perimeter Sealing and Finishing

4. Seal and tool interior and exterior perimeter with CRL **Cat. No. M64** construction sealant (not included). For exterior applications using the Step Sill be sure all edges of the sill, inside and outside are thoroughly sealed.
5. Clean the window with CRL **Cat. No. 1973** Glass Cleaner (not included) and CRL **Cat. No. 1550** Lint Free Shop Towels (not included).

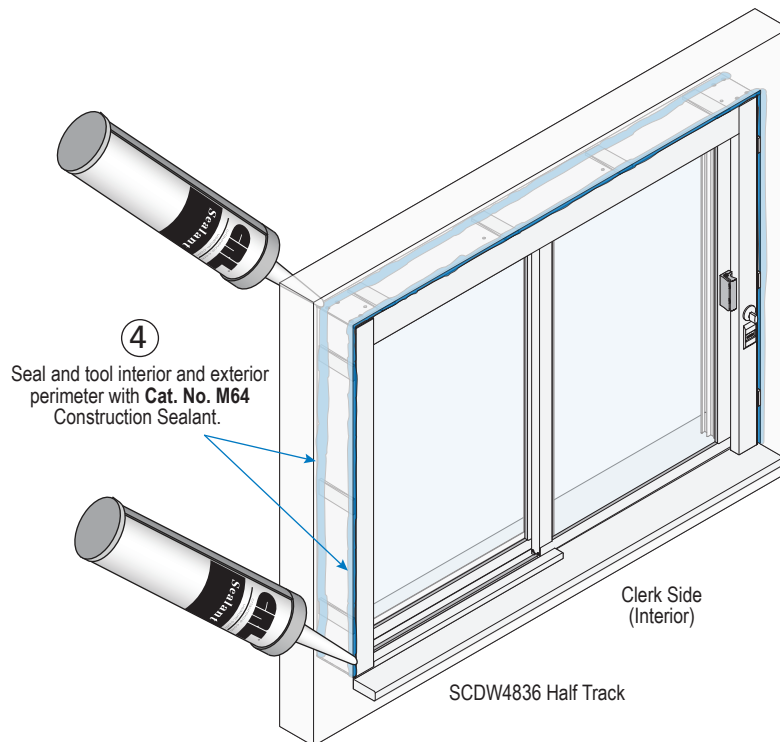

SCDW4836S STEP SILL INSTALLATION

Follow Steps 1 - 5 for DW4836 Half Track Installation.

NOTE: For exterior applications, thoroughly seal all inside and outside edges of the Step Sill.

