

**CRL BLUMCRAFT SERIES 250 ENTRANCE SYSTEMS**  
**DOUBLE DOOR AND SIDELITES (WITH CLAD HEADERS & SILLS)**

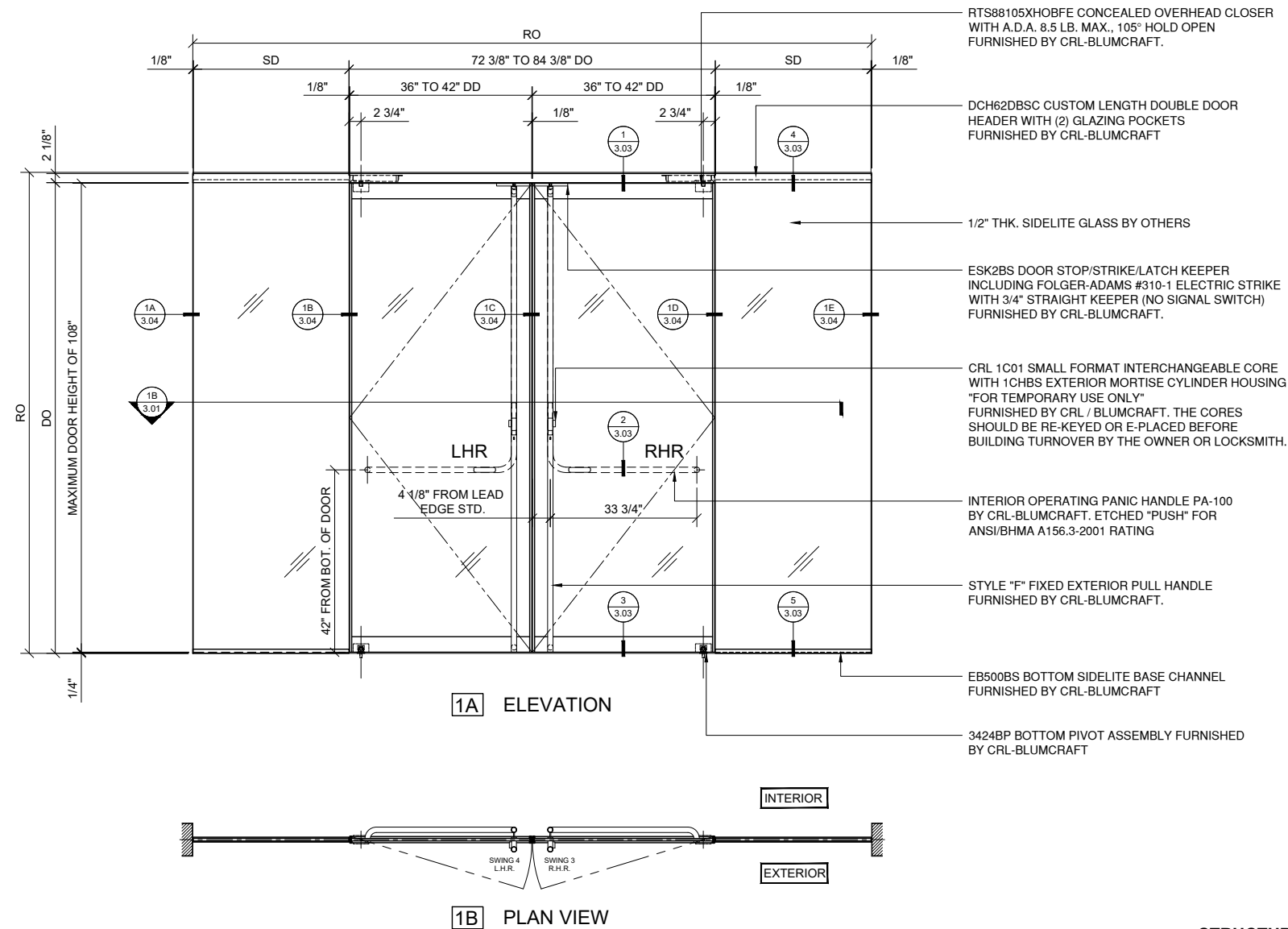

- \* FULLY GLAZED WITH 1/2", 5/8" OR 3/4" (12,16 OR 19MM ) TEMPERED GLASS IN CLEAR, TINTED OR LOW-IRON
- \* VERTICAL STILES INCLUDED ON SERIES 250 DOORS
- \* COMPLETE WITH EGRESS HANDLE IF REQUIRED
- \*150 AND 250 SERIES DOORS HAVE A SOLID ALUMINUM NARROW PROFILE RAIL DESIGN WHICH CAN BE USED TOP OR BOTTOM.
- \* SATIN ANODIZED, BLACK BRONZE ANODIZED, BLACK POWDER COAT, BRUSHED AND POLISHED STAINLESS STEEL, AND POLISHED BRASS FINISHES AVAILABLE
- \* CUSTOM FINISHES AVAILABLE
- \* HEADERS COMPATIBLE WITH OVERHEAD CONCEALED CLOSER AND CUSTOM BOTTOM PIVOT
- \* FULLY GLAZED SIDELITES TO MATCH SERIES 150 AND 250 SERIES DOORS ARE AVAILABLE
- \*HERCULITE + STYLE DOORS

**STRUCTURAL DISCLAIMER:**  
 ALL CUSTOMERS WHO IN ANY WAY UTILIZE THIS PRODUCT ARE SOLELY RESPONSIBLE TO CONSULT A STRUCTURAL ENGINEER TO DETERMINE THE SUITABILITY OF THE PRODUCT FOR THE INTENDED USE AND SITE CONDITIONS. ALL INSTALLERS MUST BE QUALIFIED AND HAVE PROFESSIONAL KNOWLEDGE ABOUT COMPLIANCE WITH LOCAL, STATE AND FEDERAL REGULATIONS, SAFETY FACTORS, AND THE APPROPRIATE CHOICE OF FIXING MATERIAL AND PROCEDURES.

**1 DOUBLE DOOR W/ SIDELITE: PA100F PANIC HANDLES**  
 3/4" = 1'-0"

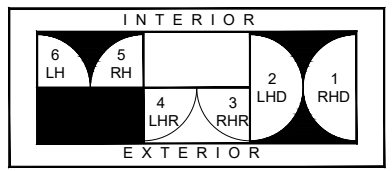

STANDARD ABBREVIATIONS	
RO	ROUGH OPENING
FD	FRAME DIMENSION
DLO	DAYLIGHT OPENING
DO	DOOR OPENING
DD	DOOR DIMENSION
TD	TRANSOM DIMENSION
SD	SIDELITE DIMENSION
SMC	SURFACE MOUNTED CLOSER
OHCC	OVERHEAD CONCEALED CLOSER
FIBO	FURNISHED & INSTALLED BY OTHERS

Revisions By:



2503 E. Vernon Avenue, Los Angeles, CA 90058-1887  
 PH (800)-421-6144 FX 800-587-7501 www.crlaurence.com

**Description:**  
 CRL / BLUMCRAFT 250  
 SRS ENTRANCE SYSTEM  
 WITH 1/2", 5/8" & 3/4"  
 GLASS

Drawn By: RPD  
 Date: 04/23/19  
 Scale: AS NOTED  
 File Name: BC\_250\_SRS\_Entrance\_Sys.dwg

**CRL BLUMCRAFT SERIES 250 ENTRANCE SYSTEMS**  
**SINGLE DOOR AND SIDELITES (WITH CLAD HEADERS & SILLS)**

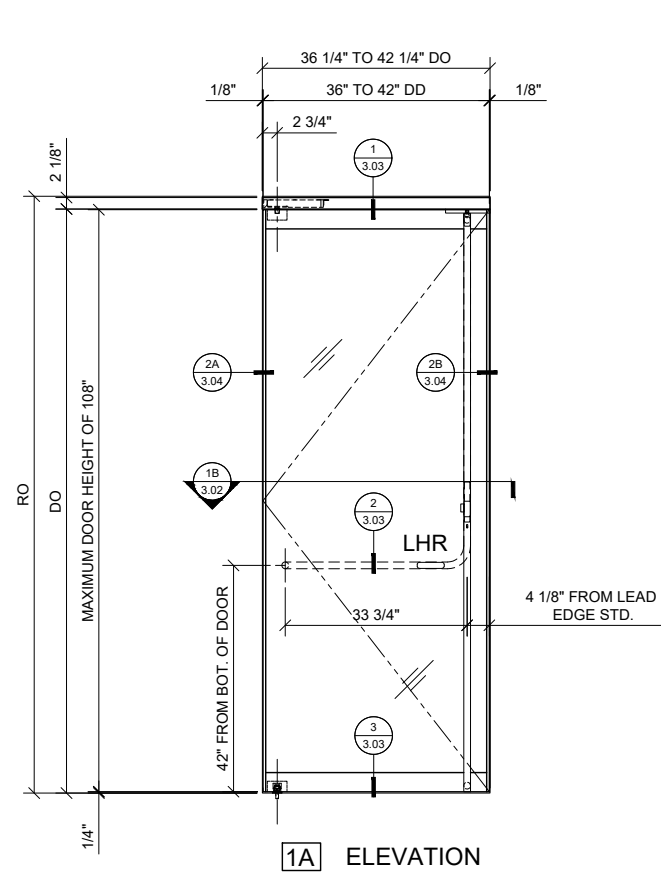

**1A** ELEVATION

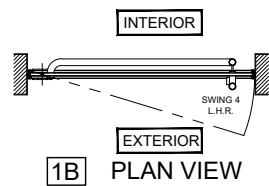

**1B** PLAN VIEW

**1** SINGLE DOOR: PA100F PANIC HANDLE  
 3/4" = 1'-0" ARCH. REF.: N/A

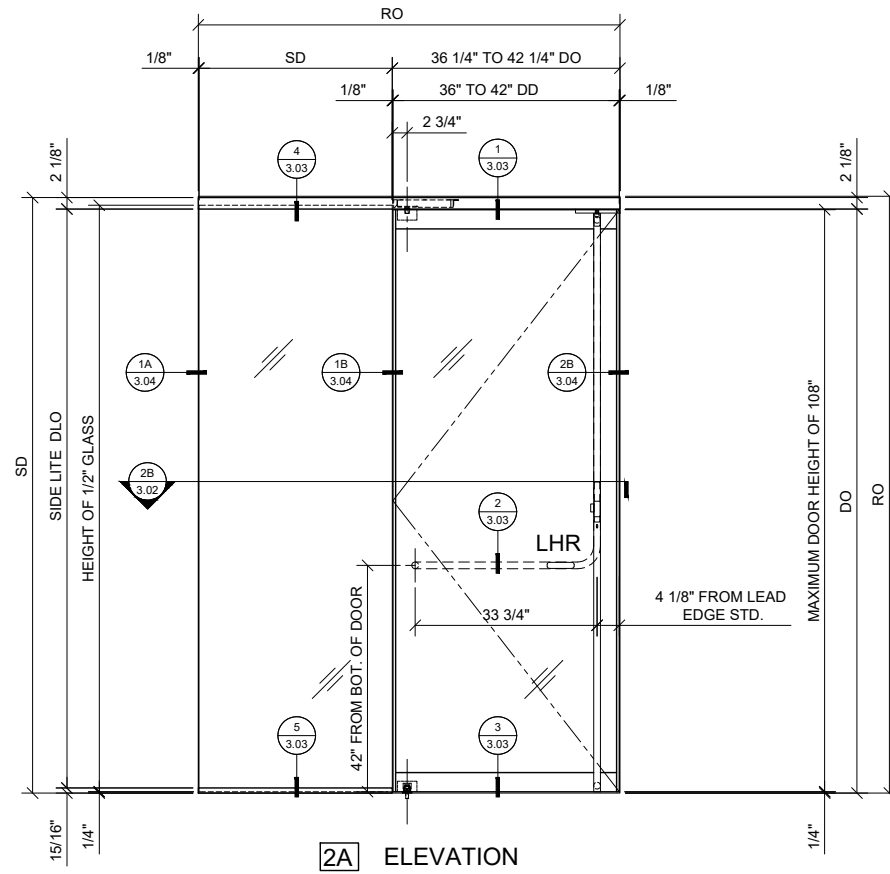

**2A** ELEVATION

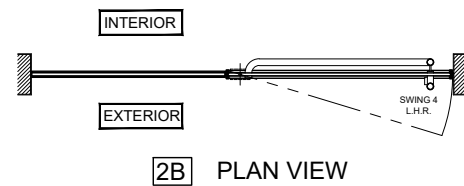

**2B** PLAN VIEW

**2** SINGLE DOOR W/ SIDELITE:  
 PA100F PANIC HANDLES  
 3/4" = 1'-0"

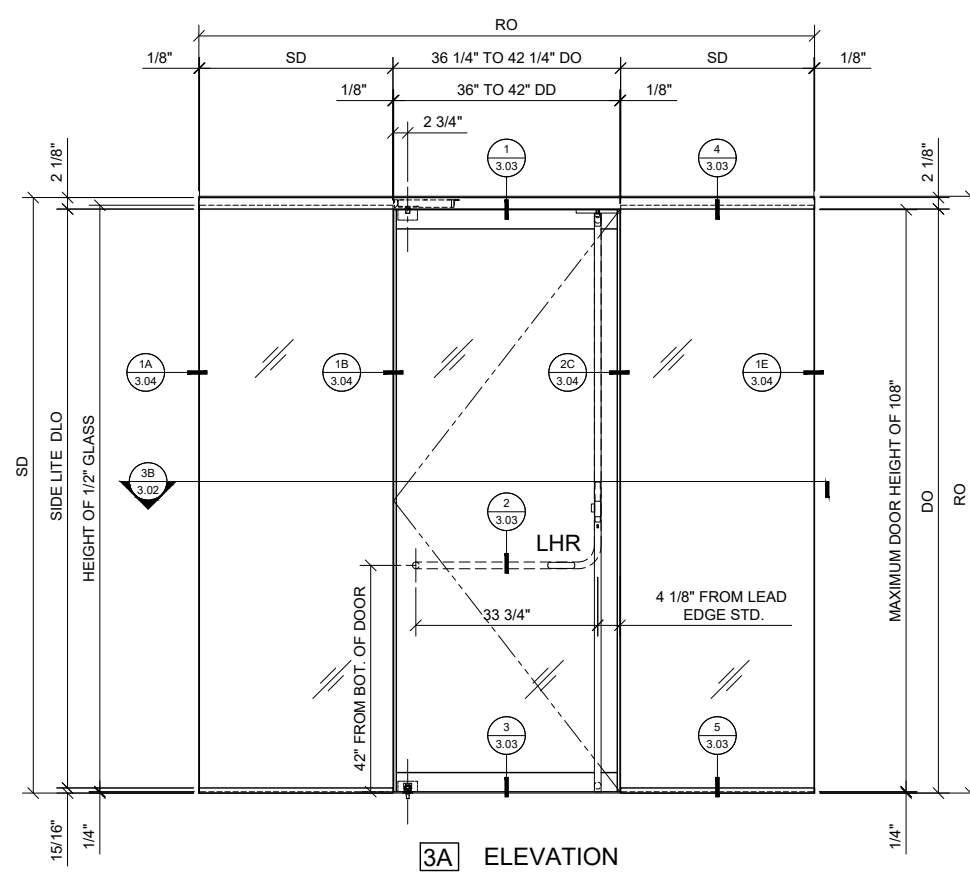

**3A** ELEVATION

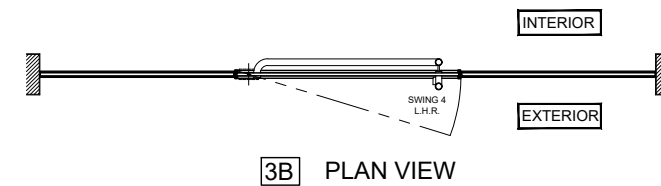

**3B** PLAN VIEW

**3** SINGLE DOOR W/ SIDELITE:  
 PA100F PANIC HANDLES  
 3/4" = 1'-0"

Revisions By:

**CRL**

2503 E. Vernon Avenue, Los Angeles, CA 90058-1887  
 PH (800)-421-6144 FX 800-587-7501 www.crlaurence.com

Description:  
 CRL / BLUMCRAFT 250  
 SRS ENTRANCE SYSTEM  
 WITH 1/2", 5/8" & 3/4"  
 GLASS

Drawn By: RPD  
 Date: 04/23/19  
 Scale: AS NOTED  
 File Name:  
 BC\_250\_SRS\_Entrance\_Sys.dwg

Sheet  
**3.02**

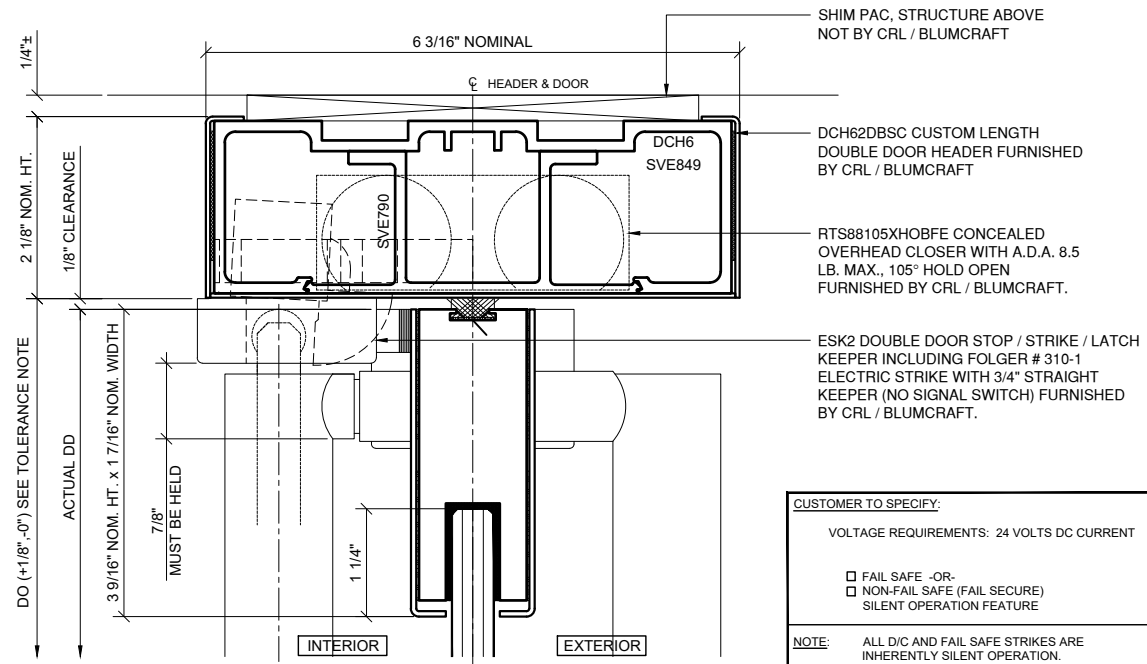

**1 SECTION AT DOOR HEAD**

ARCH REF: N/A 1'-0"=1'-0"

**CUSTOMER TO SPECIFY:**

VOLTAGE REQUIREMENTS: 24 VOLTS DC CURRENT

FAIL SAFE -OR-  
 NON-FAIL SAFE (FAIL SECURE)  
 SILENT OPERATION FEATURE

**NOTE:** ALL D/C AND FAIL SAFE STRIKES ARE INHERENTLY SILENT OPERATION.

**CAUTION:** TO PROTECT ELECTRIC STRIKE(S) FROM POWER SPIKES AND ASSIST IN REGULATING A SP2005M3 (SMART PAC III) WILL BE SUPPLIED FOR EACH FAIL SAFE ELECTRIC STRIKE BY CRL / BLUMCRAFT.

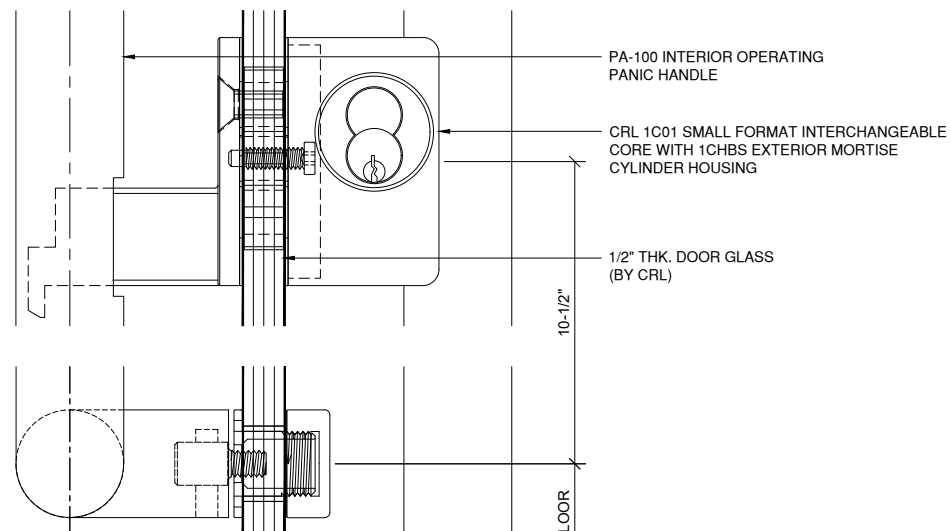

**2 SECTION AT DOOR PULL**

ARCH REF: N/A 1'-0"=1'-0"

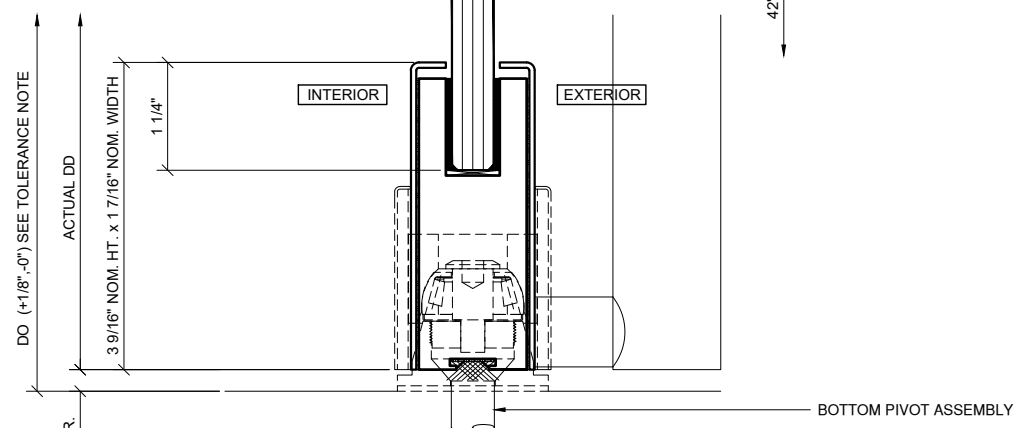

**3 SECTION AT DOOR SILL**

ARCH REF: N/A 1'-0"=1'-0"

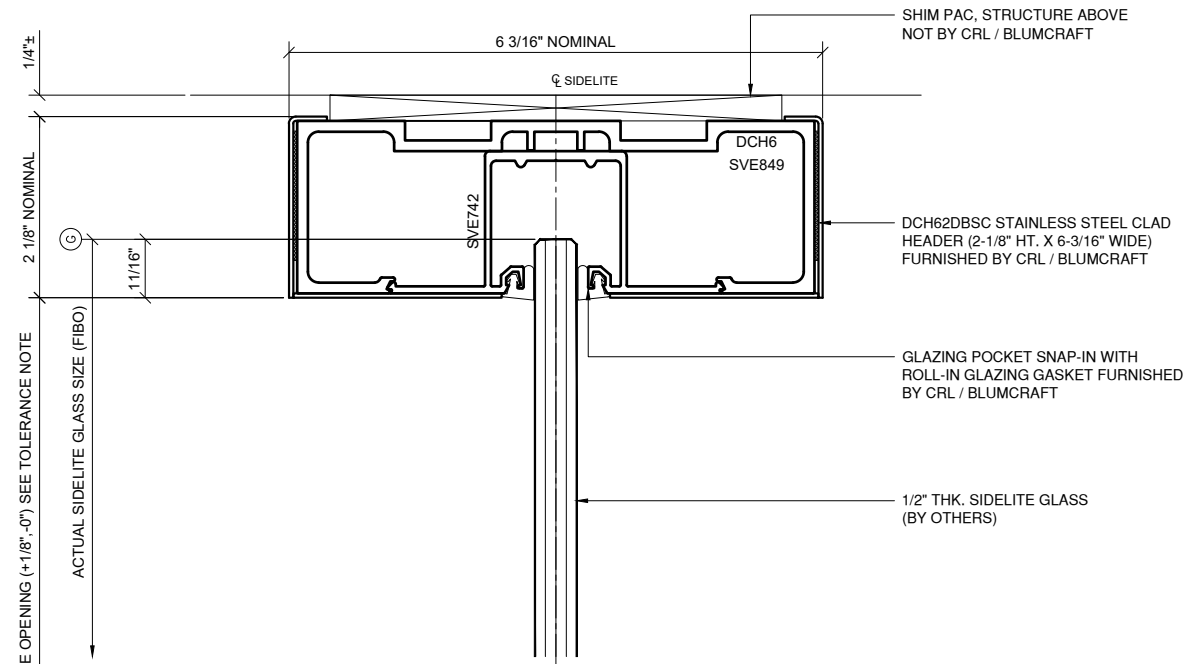

**4 SECTION AT SIDELITE HEAD**

ARCH REF: N/A 1'-0"=1'-0"

**TOLERANCE NOTE:**

CEILINGS, FRAMES, OR FLOORS WITHIN THE ENTIRE SWING-ARC OF THE DOOR SHOULD HAVE THE SAME MINIMUM DIMENSIONAL TOLERANCES AS THE DOOR FRAME OPENING TO ASSURE PROPER DOOR FUNCTION.

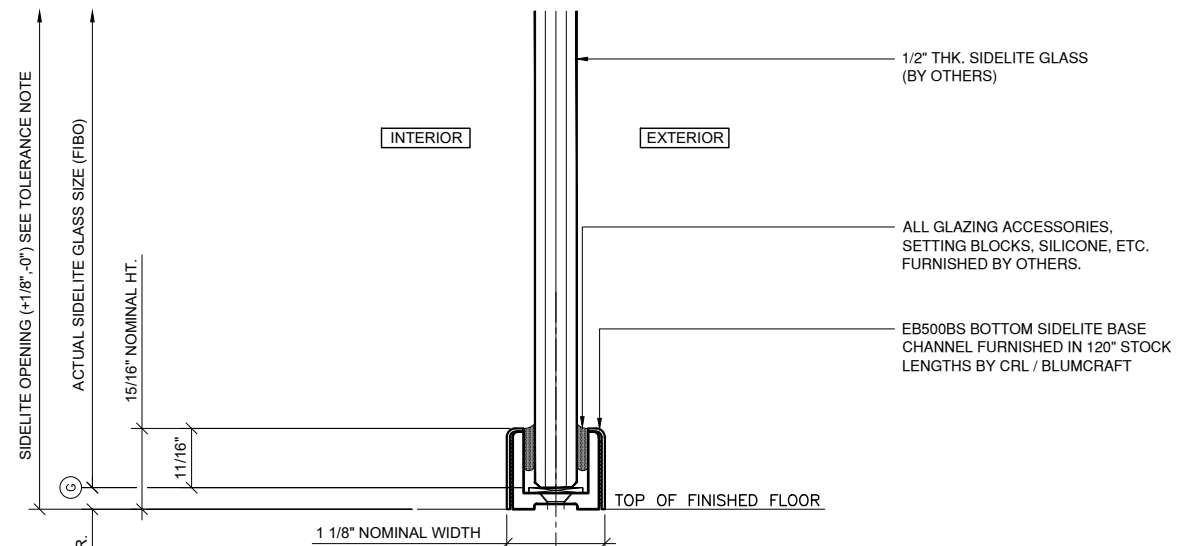

**5 SECTION AT SIDELITE SILL**

ARCH REF: N/A 1'-0"=1'-0"

Revisions By:

**CRL**

2503 E. Vemon Avenue, Los Angeles, CA 90058-1897  
 PH (800)-421-6144 FX 800-587-7501 www.crlaurence.com

**Description:**  
 CRL / BLUMCRAFT 250  
 SRS ENTRANCE SYSTEM  
 WITH 1/2", 5/8" & 3/4"  
 GLASS

Drawn By: RPD  
 Date: 04/23/19  
 Scale: AS NOTED  
 File Name: BC\_250\_SRS\_Entrance\_Sys.dwg

Sheet  
**3.03**

Revisions By:

# CRL

2503 E. Vernon Avenue, Los Angeles, CA 90058-1887  
PH (800)-421-6144 FX 800-587-7501 www.crlaurence.com

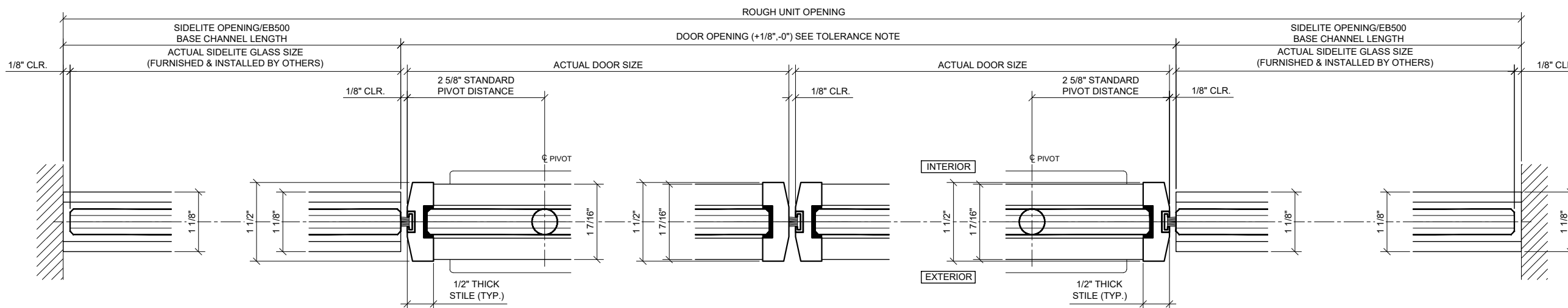

1A PLAN: WALL TO SIDE LITE

1B PLAN: SIDELITE TO DOOR

1C PLAN: MEETING STILE

1D PLAN: DOOR TO SIDELITE

1E PLAN: SIDELITE TO WALL

### 1 SECTIONS AT DOOR / SIDELITE / WALL

ARCH REF: N/A 1'-0"=1'-0"

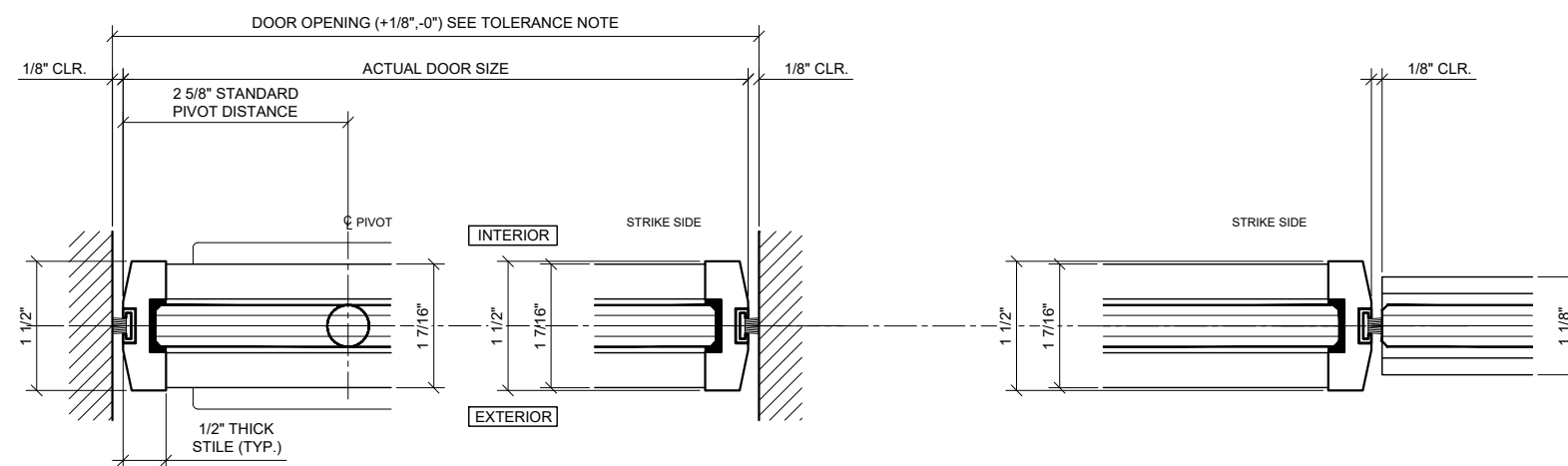

2A PLAN: WALL TO DOOR

2B PLAN: DOOR TO WALL

2C PLAN: DOOR TO SIDELITE

### 2 SECTIONS AT DOOR / SIDELITE / WALL

ARCH REF: N/A 1'-0"=1'-0"

Description:  
CRL / BLUMCRAFT 250  
SRS ENTRANCE SYSTEM  
WITH 1/2", 5/8" & 3/4"  
GLASS

Drawn By: RPD

Date: 04/23/19

Scale: AS NOTED

File Name:

BC\_250\_SRS\_Entrance\_Sys.dwg

Sheet

3.04

**CRL BLUMCRAFT SERIES 250 ENTRANCE SYSTEMS**  
**DOUBLE DOOR AND SIDELITES (WITH NON-CLAD HEADERS & SILLS)**

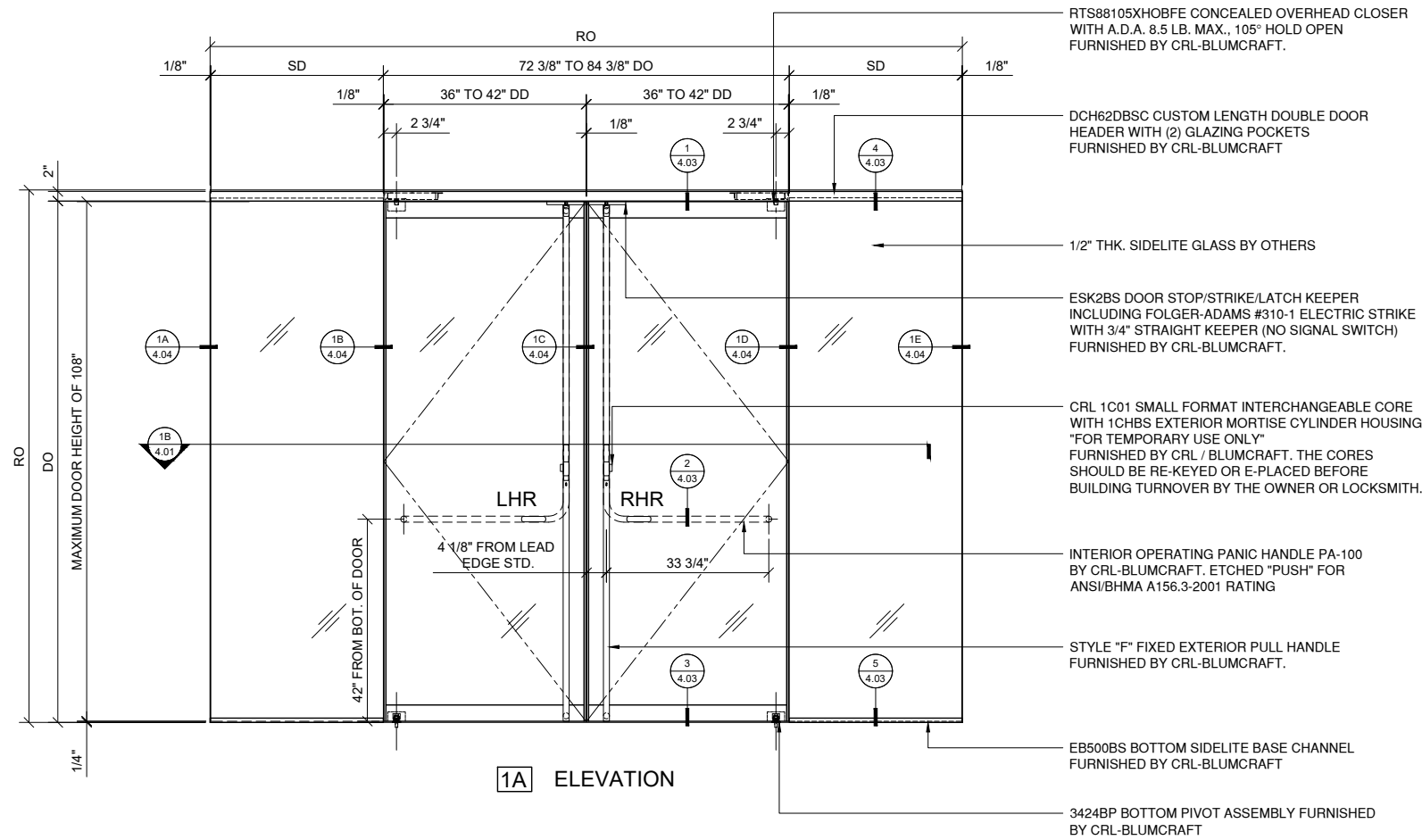

- \* FULLY GLAZED WITH 1/2", 5/8" OR 3/4" (12,16 OR 19MM ) TEMPERED GLASS IN CLEAR, TINTED OR LOW-IRON
- \* VERTICAL STILES INCLUDED ON SERIES 250 DOORS
- \* COMPLETE WITH EGRESS HANDLE IF REQUIRED
- \*150 AND 250 SERIES DOORS HAVE A SOLID ALUMINUM NARROW PROFILE RAIL DESIGN WHICH CAN BE USED TOP OR BOTTOM.
- \* SATIN ANODIZED, BLACK BRONZE ANODIZED, BLACK POWDER COAT, BRUSHED AND POLISHED STAINLESS STEEL, AND POLISHED BRASS FINISHES AVAILABLE
- \* CUSTOM FINISHES AVAILABLE
- \* HEADERS COMPATIBLE WITH OVERHEAD CONCEALED CLOSER AND CUSTOM BOTTOM PIVOT
- \* FULLY GLAZED SIDELITES TO MATCH SERIES 150 AND 250 SERIES DOORS ARE AVAILABLE
- \*HERCULITE + STYLE DOORS

- RTS88105XHOBFE CONCEALED OVERHEAD CLOSER WITH A.D.A. 8.5 LB. MAX., 105° HOLD OPEN FURNISHED BY CRL-BLUMCRAFT.
- DCH62DBSC CUSTOM LENGTH DOUBLE DOOR HEADER WITH (2) GLAZING POCKETS FURNISHED BY CRL-BLUMCRAFT
- 1/2" THK. SIDELITE GLASS BY OTHERS
- ESK2BS DOOR STOP/STRIKE/LATCH KEEPER INCLUDING FOLGER-ADAMS #310-1 ELECTRIC STRIKE WITH 3/4" STRAIGHT KEEPER (NO SIGNAL SWITCH) FURNISHED BY CRL-BLUMCRAFT.
- CRL 1C01 SMALL FORMAT INTERCHANGEABLE CORE WITH 1CHBS EXTERIOR MORTISE CYLINDER HOUSING "FOR TEMPORARY USE ONLY" FURNISHED BY CRL / BLUMCRAFT. THE CORES SHOULD BE RE-KEYED OR E-PLACED BEFORE BUILDING TURNOVER BY THE OWNER OR LOCKSMITH.
- INTERIOR OPERATING PANIC HANDLE PA-100 BY CRL-BLUMCRAFT. ETCHED "PUSH" FOR ANSI/BHMA A156.3-2001 RATING
- STYLE "F" FIXED EXTERIOR PULL HANDLE FURNISHED BY CRL-BLUMCRAFT.
- EB500BS BOTTOM SIDELITE BASE CHANNEL FURNISHED BY CRL-BLUMCRAFT
- 3424BP BOTTOM PIVOT ASSEMBLY FURNISHED BY CRL-BLUMCRAFT

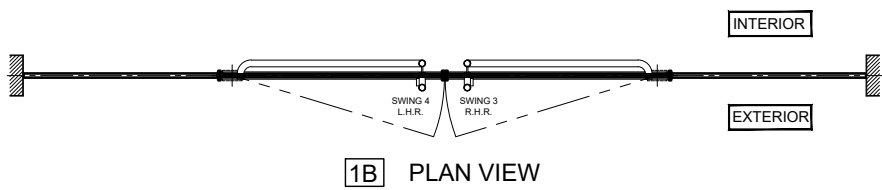

**1** DOUBLE DOOR W/ SIDELITE: PA100F PANIC HANDLES  
 3/4" x 1'-0"

**STRUCTURAL DISCLAIMER:**  
 ALL CUSTOMERS WHO IN ANY WAY UTILIZE THIS PRODUCT ARE SOLELY RESPONSIBLE TO CONSULT A STRUCTURAL ENGINEER TO DETERMINE THE SUITABILITY OF THE PRODUCT FOR THE INTENDED USE AND SITE CONDITIONS. ALL INSTALLERS MUST BE QUALIFIED AND HAVE PROFESSIONAL KNOWLEDGE ABOUT COMPLIANCE WITH LOCAL, STATE AND FEDERAL REGULATIONS, SAFETY FACTORS, AND THE APPROPRIATE CHOICE OF FIXING MATERIAL AND PROCEDURES.

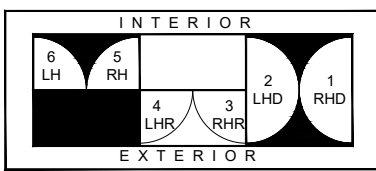

STANDARD ABBREVIATIONS	
RO	ROUGH OPENING
FD	FRAME DIMENSION
DLO	DAYLIGHT OPENING
DO	DOOR OPENING
DD	DOOR DIMENSION
TD	TRANSOM DIMENSION
SD	SIDELITE DIMENSION
SMC	SURFACE MOUNTED CLOSER
OHCC	OVERHEAD CONCEALED CLOSER
FIBO	FURNISHED & INSTALLED BY OTHERS

Revisions By:



2503 E. Vernon Avenue, Los Angeles, CA 90058-1887  
 PH (800)-421-6144 FX 800-587-7501 www.crlaurence.com

Description:  
 CRL / BLUMCRAFT 250  
 SRS ENTRANCE SYSTEM  
 WITH 1/2", 5/8" & 3/4"  
 GLASS

Drawn By: RPD  
 Date: 04/23/19  
 Scale: AS NOTED  
 File Name: BC\_250\_SRS\_Entrance\_Sys.dwg

**CRL BLUMCRAFT SERIES 250 ENTRANCE SYSTEMS**  
**SINGLE DOOR AND SIDELITES (WITH NON-CLAD HEADERS & SILLS)**

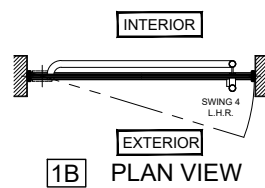
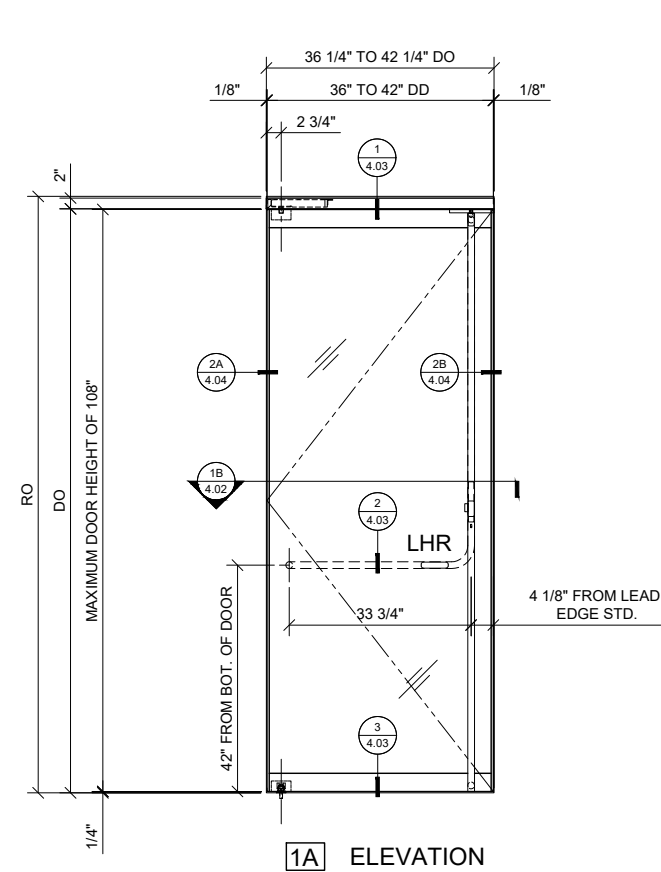

**1** SINGLE DOOR: PA100F PANIC HANDLE  
 3/4" = 1'-0" ARCH. REF.: NA

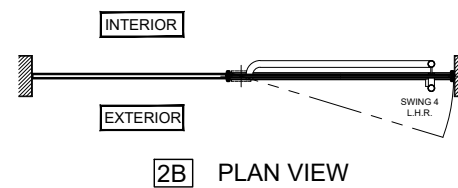
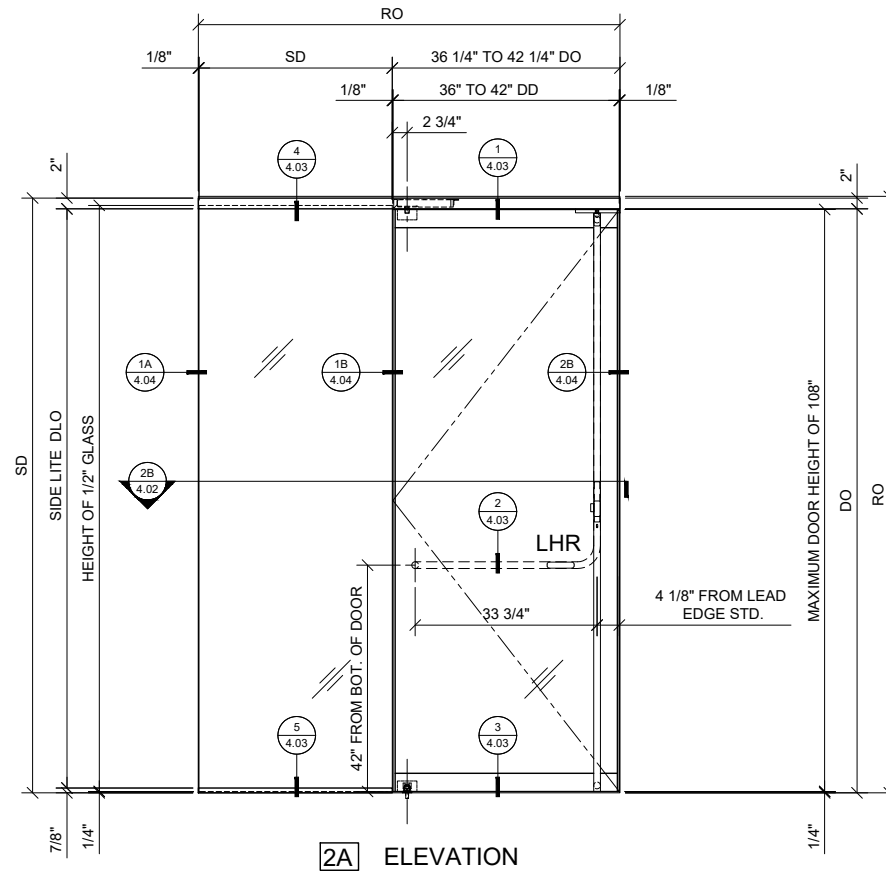

**2** SINGLE DOOR W/ SIDELITE:  
 PA100F PANIC HANDLES  
 3/4" = 1'-0"

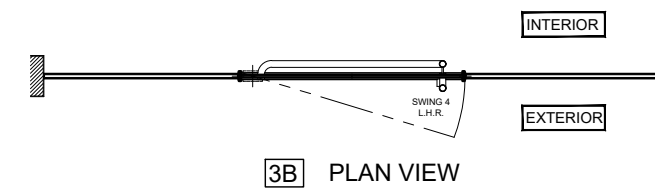
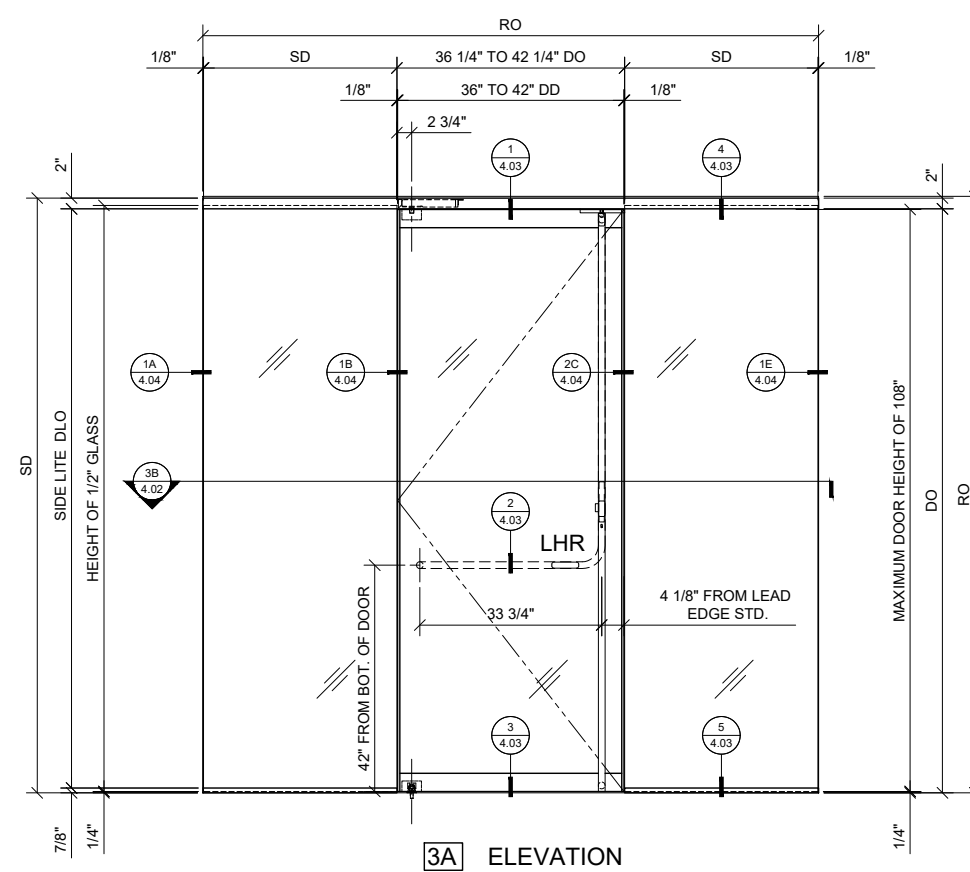

**3** SINGLE DOOR W/ SIDELITE:  
 PA100F PANIC HANDLES  
 3/4" = 1'-0"

Revisions By:

**CRL**

2503 E. Vernon Avenue, Los Angeles, CA 90058-1887  
 PH (800)-421-6144 FX 800-587-7501 www.crlaurence.com

Description:  
 CRL / BLUMCRAFT 250  
 SRS ENTRANCE SYSTEM  
 WITH 1/2", 5/8" & 3/4"  
 GLASS

Drawn By: RPD  
 Date: 04/23/19  
 Scale: AS NOTED  
 File Name:  
 BC\_250\_SRS\_Entrance\_Sys.dwg

Sheet  
**4.02**

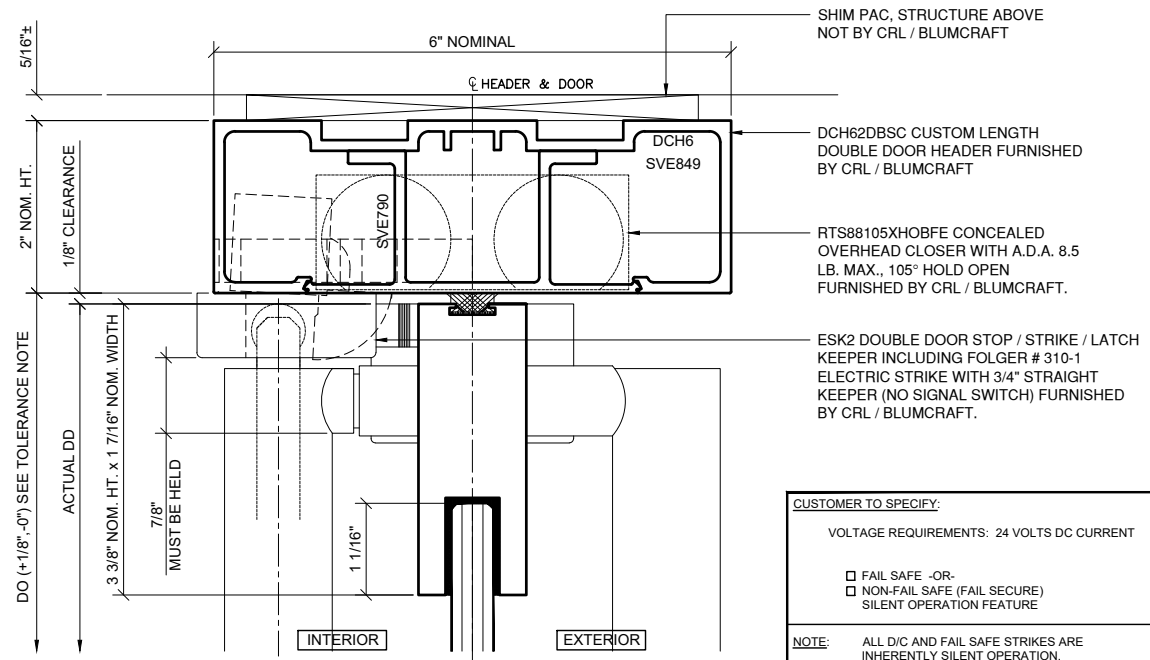

**1 SECTION AT DOOR HEAD**  
 ARCH REF: N/A 1'-0"=1'-0"

**CUSTOMER TO SPECIFY:**

VOLTAGE REQUIREMENTS: 24 VOLTS DC CURRENT

FAIL SAFE -OR-  
 NON-FAIL SAFE (FAIL SECURE)  
 SILENT OPERATION FEATURE

**NOTE:** ALL D/C AND FAIL SAFE STRIKES ARE INHERENTLY SILENT OPERATION.

**CAUTION:** TO PROTECT ELECTRIC STRIKE(S) FROM POWER SPIKES AND ASSIST IN REGULATING A SP2005M3 (SMART PAC III) WILL BE SUPPLIED FOR EACH FAIL SAFE ELECTRIC STRIKE BY CRL / BLUMCRAFT.

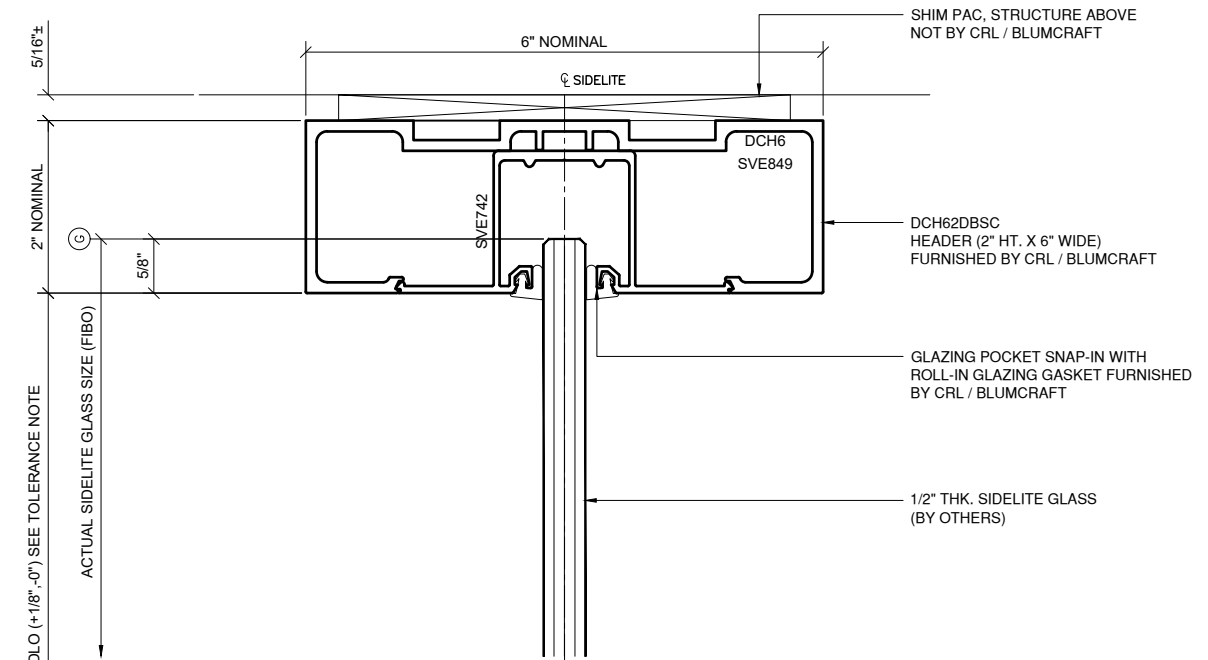

**4 SECTION AT SIDELITE HEAD**  
 ARCH REF: N/A 1'-0"=1'-0"

**TOLERANCE NOTE:**  
 CEILINGS, FRAMES, OR FLOORS WITHIN THE ENTIRE SWING-ARC OF THE DOOR SHOULD HAVE THE SAME MINIMUM DIMENSIONAL TOLERANCES AS THE DOOR FRAME OPENING TO ASSURE PROPER DOOR FUNCTION.

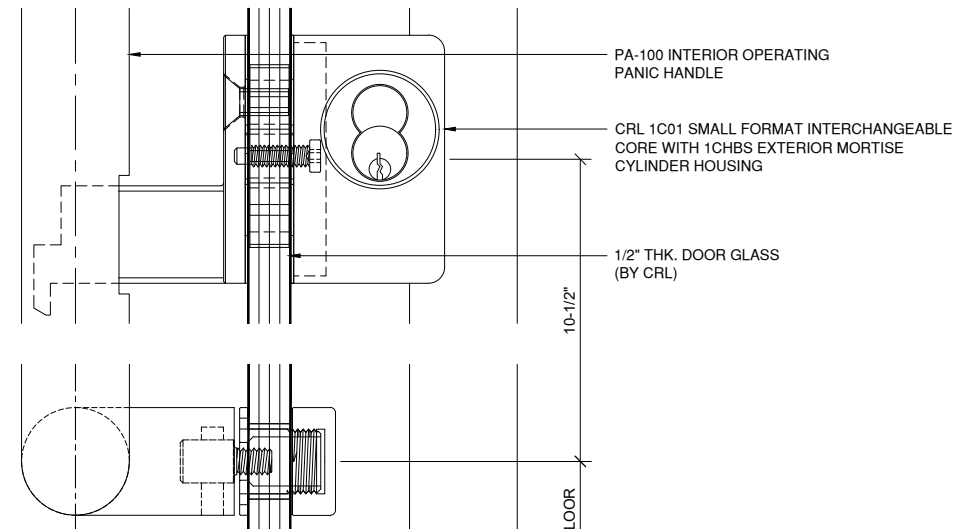

**2 SECTION AT DOOR PULL**  
 ARCH REF: N/A 1'-0"=1'-0"

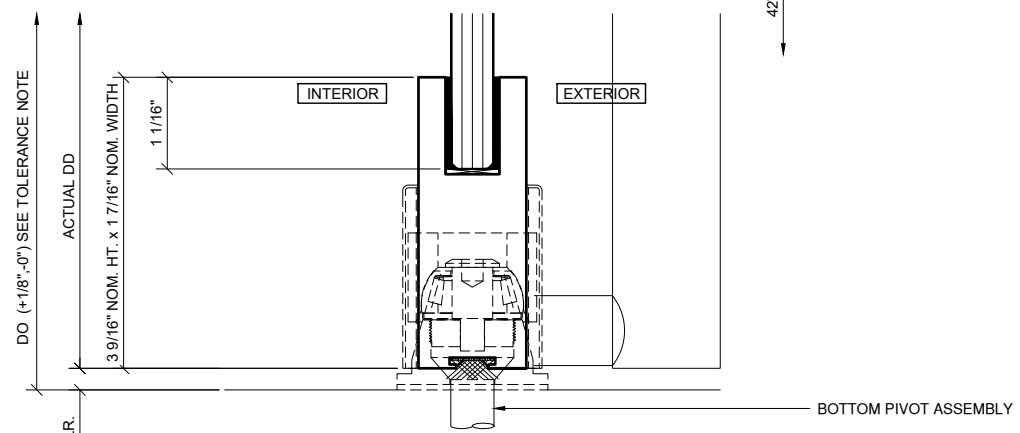

**3 SECTION AT DOOR SILL**  
 ARCH REF: N/A 1'-0"=1'-0"

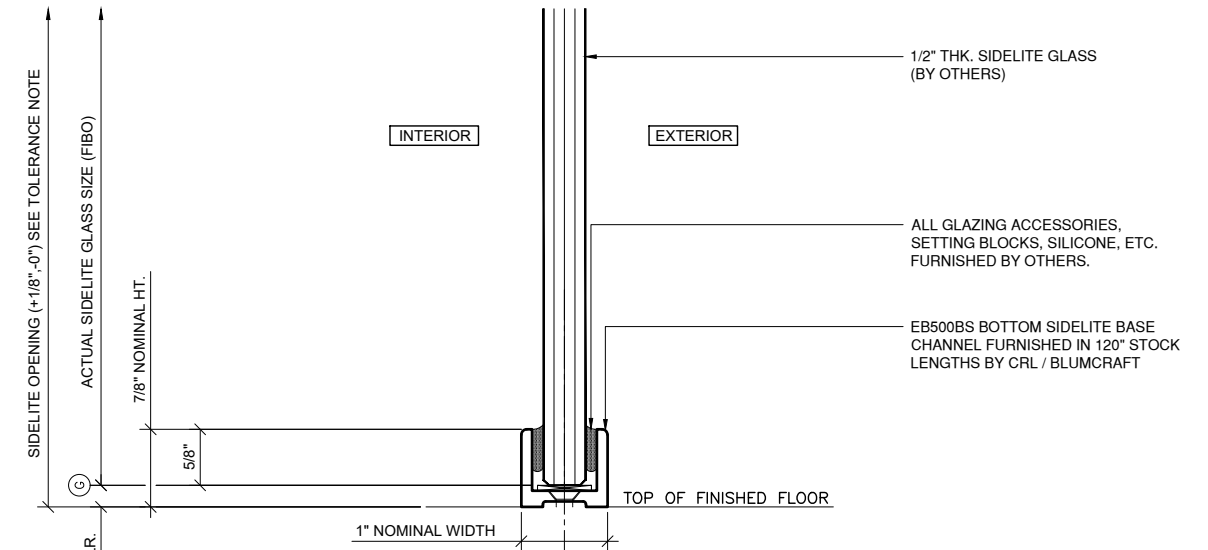

**5 SECTION AT SIDELITE SILL**  
 ARCH REF: N/A 1'-0"=1'-0"

Revisions By:

**CRL**

2503 E. Vernon Avenue, Los Angeles, CA 90058-1887  
 PH (800)-421-6144 FX (800)-587-7501 www.crlaurence.com

**Description:**  
 CRL / BLUMCRAFT 250  
 SRS ENTRANCE SYSTEM  
 WITH 1/2", 5/8" & 3/4"  
 GLASS

Drawn By: RPD  
 Date: 04/23/19  
 Scale: AS NOTED  
 File Name: BC\_250\_SRS\_Entrance\_Sys.dwg

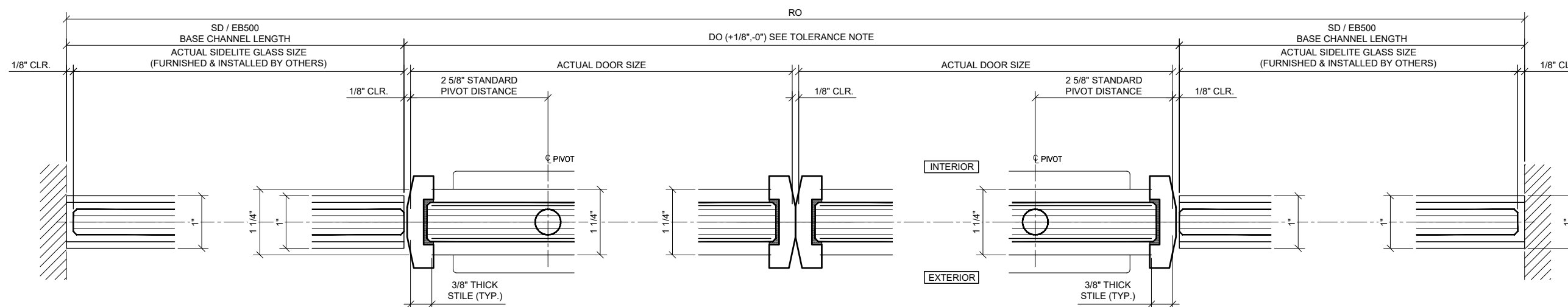

1A PLAN: WALL TO SIDE LITE

1B PLAN: SIDELITE TO DOOR

1C PLAN: MEETING STILE

1D PLAN: DOOR TO SIDELITE

1E PLAN: SIDELITE TO WALL

1 SECTIONS AT DOOR / SIDELITE / WALL

ARCH REF: N/A 1'-0"=1'-0"

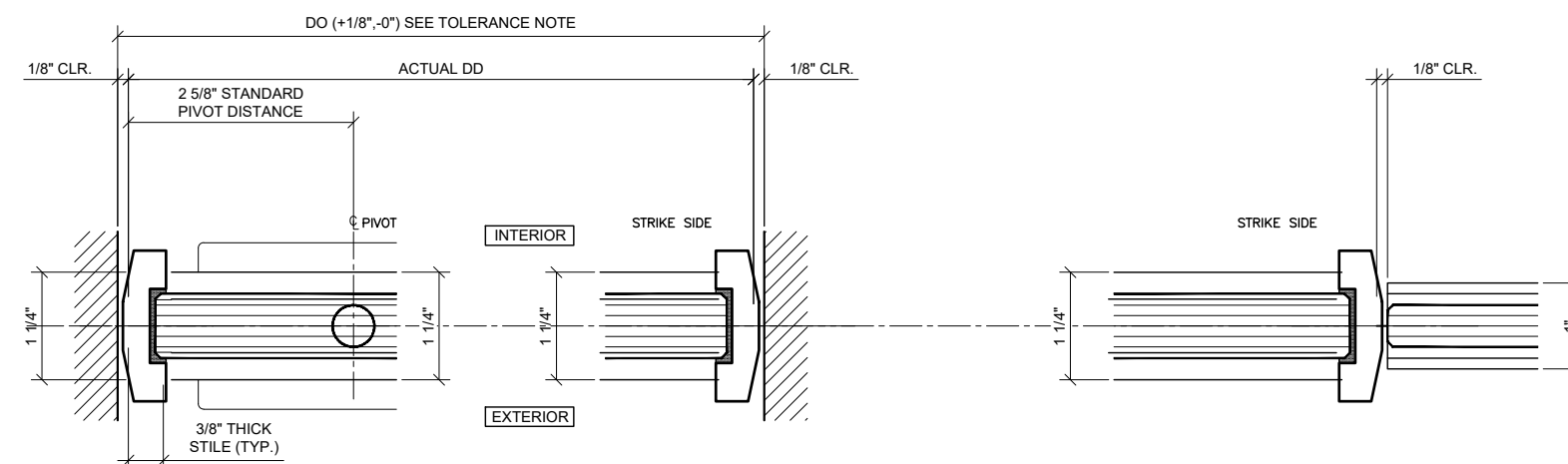

2A PLAN: WALL TO DOOR

2B PLAN: DOOR TO WALL

2C PLAN: DOOR TO SIDELITE

2 SECTIONS AT DOOR / SIDELITE / WALL

ARCH REF: N/A 1'-0"=1'-0"

Description:  
 CRL / BLUMCRAFT 250  
 SRS ENTRANCE SYSTEM  
 WITH 1/2", 5/8" & 3/4"  
 GLASS

Drawn By: RPD

Date: 04/23/19

Scale: AS NOTED

File Name:

BC\_250\_SRS\_Entrance\_Sys.dwg

Sheet

4.04